



10335





LEGO.com/sustainable-packaging



FR
**DONNEZ
OU
RECYCLEZ**



ASSOCIATION

OU



MAGASIN

OU



DÉCHÈTERIE

Adresses sur quefairedemesdechets.fr



BUILDER



Apple and the Apple logo are trademarks of Apple Inc., registered in the U.S. and other countries and regions. App Store is a service mark of Apple Inc. Google Play and the Google Play logo are trademarks of Google LLC. Tencent and the Tencent logo are trademarks of Tencent Inc.

LEGO.com/devicecheck



LEGO® Builder



Redescubrimiento del Endurance

En 2022, un siglo después del fallecimiento de Sir Ernest Shackleton, se redescubrieron los restos de su más legendaria embarcación, el Endurance, en el lecho del mar de Weddell, frente a las costas de la Antártida. Botado por primera vez en 1912, el que fuera velero de lujo se remodeló para hacerlo capaz de resistir los entornos más inhóspitos y proteger a su tripulación de los elementos en la expedición imperial transantártica liderada por Shackleton en 1914. La temeraria misión de cruzar la Antártida fracasó, ya que los hielos polares engulleron al Endurance antes de llegar a la costa. No obstante, la supervivencia de su tripulación se convirtió en una de las crónicas de resistencia humana, ingenio y compañerismo más inspiradoras del siglo pasado. Aunque el Endurance permanecerá en su lugar de descanso final, el redescubrimiento de los restos del naufragio, extraordinariamente bien conservados, vuelve a sacar a la superficie su increíble historia. Esperamos que disfrutes construyendo mientras celebramos este épico episodio de supervivencia con un magnífico modelo LEGO® Icons repleto de los detalles más minuciosos.



El Tratado Antártico

El 1 de diciembre de 1959, doce países firmaron el Tratado Antártico para preservar el continente como centro independiente de investigación científica. Según el tratado, al no haber pueblos indígenas que reivindiquen su soberanía, ningún país tiene la autoridad legal para reclamar o intentar recuperar el Endurance.

Construido para durar

/// El bergantín-goleta de tres mástiles también estaba equipado con una máquina de vapor de triple expansión para navegar entre el hielo y mantener el rumbo ante el azote de vientos intensos.

/// Una combinación de maderas de roble, pino y palo verde le dieron al casco la resistencia suficiente para soportar las condiciones más extremas.

/// Cuando se descubrieron los restos del naufragio en 2022, la estrella y las letras doradas del nombre Endurance seguían intactas.



Nadie se queda atrás

El 5 de diciembre de 1914, Shackleton y su tripulación zarparon de la estación Grytviken, en la isla Georgia del Sur, en una misión de un año cuyo objetivo era atravesar el Polo Sur. A finales de febrero de 1915, el Endurance quedó irremediablemente atrapado entre los hielos que avanzaban a la deriva por el mar de Weddell. Sin perder el ánimo, la tripulación permaneció a bordo hasta el 27 de octubre de 1915, cuando las grietas amenazaron con hundir el barco. Este se mantuvo a flote hasta que, finalmente, se hundió el 21 de noviembre.

Los 28 tripulantes usaron los botes salvavidas recuperados para establecer el campamento Patience en el hielo hasta abril de 1916, fecha en la que partieron a bordo de uno hacia la isla Elefante. A cada miembro de la tripulación se le permitió llevar un kilogramo de efectos personales, además de un banyo, ¡que Shackleton declaró medicina mental vital! Desde la isla Elefante, Shackleton y algunos de sus hombres completaron una última etapa de dos semanas hasta la isla Georgia del Sur, solo para llegar a la estación ballenera Stromness por el extremo "equivocado" de la isla bajo el embate de una impetuosa tormenta. Después de un día y medio de marcha a través de la isla, la agotada expedición regresó a la estación Grytviken. Desde allí, Shackleton necesitó casi cuatro meses y medio y numerosos intentos para rescatar a sus últimos hombres de la isla Elefante.

La historia atribuye la supervivencia de la tripulación del Endurance al extraordinario liderazgo de Sir Ernest Shackleton, destacando la abnegación y el alentador optimismo de sus heroicas acciones. Desde compartir sus guantes y ordenar a sus hombres que durmieran para mantenerlos con energía hasta desafiar todas las probabilidades para traer a todos a casa con vida, parece evidente que a su tripulación no le faltaban razones para depositar en él su confianza.



*“Resistiendo,
venceremos”.*

Lema de la familia
Shackleton



Isla Elefante

El 15 de abril de 1916, Shackleton y su tripulación pisaron tierra firme por primera vez en 497 días en la isla Elefante, donde se rescató a los últimos tripulantes el 30 de agosto de 1916.

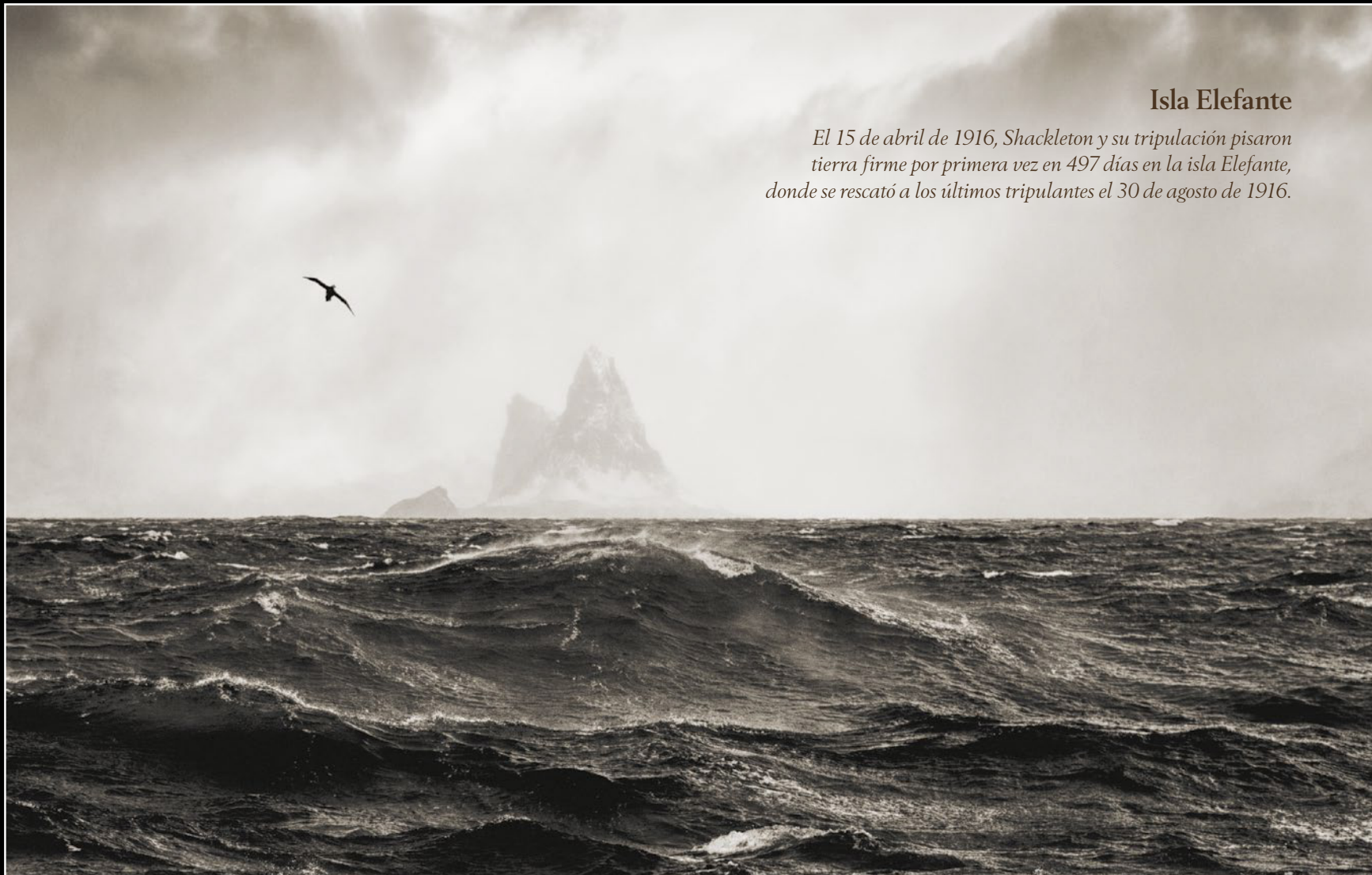

El viaje

- 1 5 de diciembre de 1914: El *Endurance* parte de la estación Grytviken, en la isla Georgia del Sur.
- 2 18 de enero de 1915: Tras navegar durante semanas por el helado mar de Weddell, el *Endurance* queda atrapado en el hielo.
- 3 21 de noviembre de 1915: Semanas después de que el casco de la embarcación empezara a resquebrajarse, esta se hunde frente a las costas de la Antártida.
- 4 15 de abril de 1916: Dos semanas después de abandonar el campamento *Patience* en uno de los botes salvavidas, la tripulación llega a la isla Elefante.
- 5 21 de mayo de 1916: Shackleton y los primeros miembros de la tripulación llegan a la isla Georgia del Sur.
- 6 30 de agosto de 1916: Se rescata a los últimos tripulantes de la isla Elefante.



Impresiones del equipo de diseño de LEGO®

“Para determinar la escala del modelo, primero elegimos un detalle importante, los botes salvavidas (que los había de dos tamaños diferentes), y los recreamos en modelos tan pequeños y minuciosos como pudimos. A partir de ahí, calculamos cuáles serían las dimensiones de la embarcación. Mientras que el Endurance original tenía espacio para 28 personas, limitar un poco la capacidad del modelo nos permitió incluir camarotes para Sir Ernest Shackleton y un científico de la expedición. El interior también muestra la máquina de vapor del barco, que puede quitarse. En la vida real, ¡la máquina de vapor era tan grande como una casa de dos plantas! Los modelos de exposición LEGO® Icons suelen tener funciones interesantes, por lo que quisimos darle un timón móvil conectado al gobernalle. Para ello, creamos un pequeño mecanismo basado en una placa en ángulo que ahora viene en marrón oscuro por primera vez. Es uno de los numerosos cambios de color de elementos que hicimos para reproducir con autenticidad el aspecto del navío. Al fin y al cabo, el Endurance fue uno de los barcos de madera más fuertes jamás contruidos, y merece un homenaje a la altura”.

*Hans Burkhard Schlömer,
modelista de LEGO®*



*“Al fin y al cabo, el
Endurance fue uno de
los barcos de madera
más fuertes jamás
construidos, y merece
un homenaje a la altura”.*



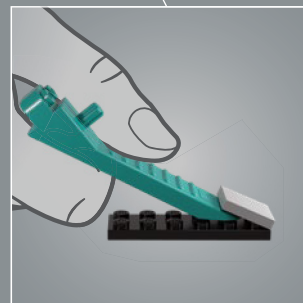
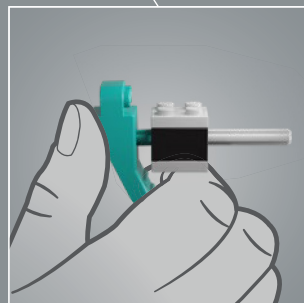
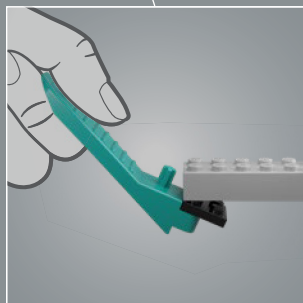
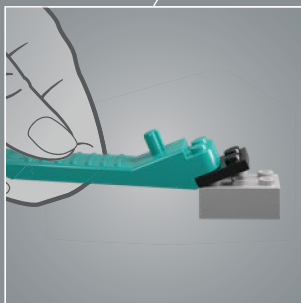
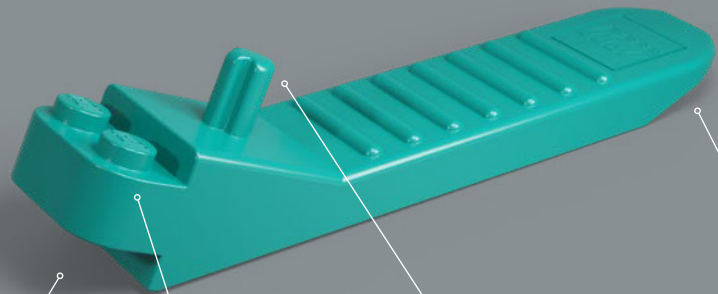

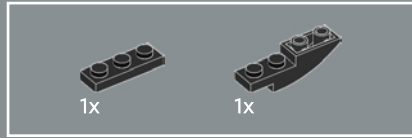

1

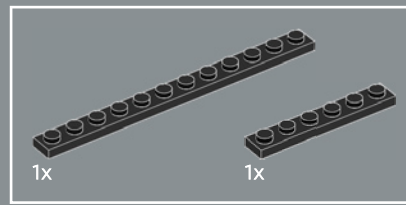
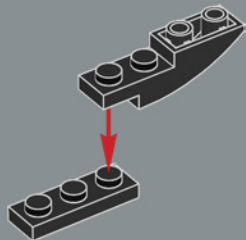

2

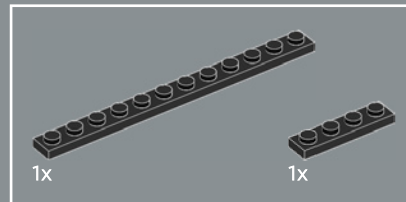
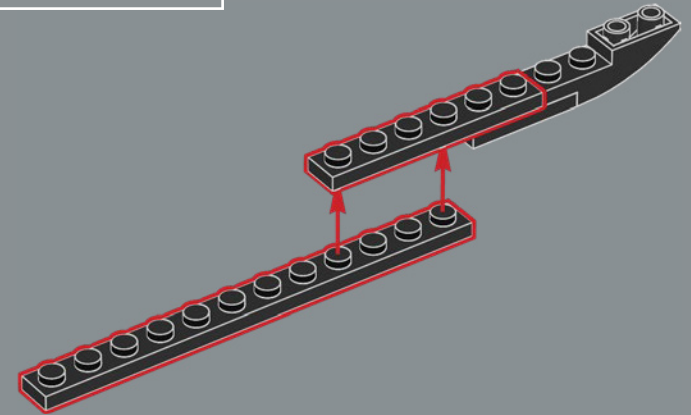

3

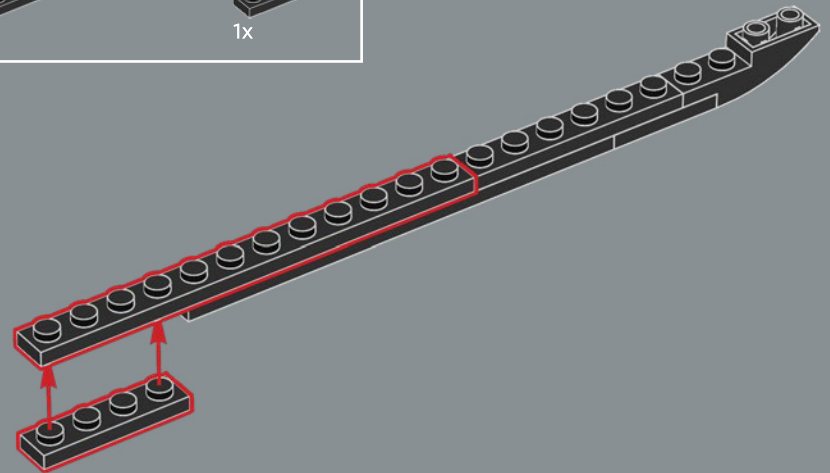

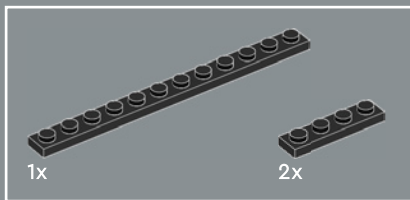

4

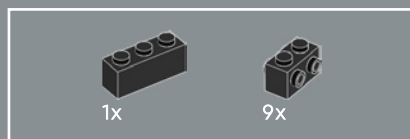
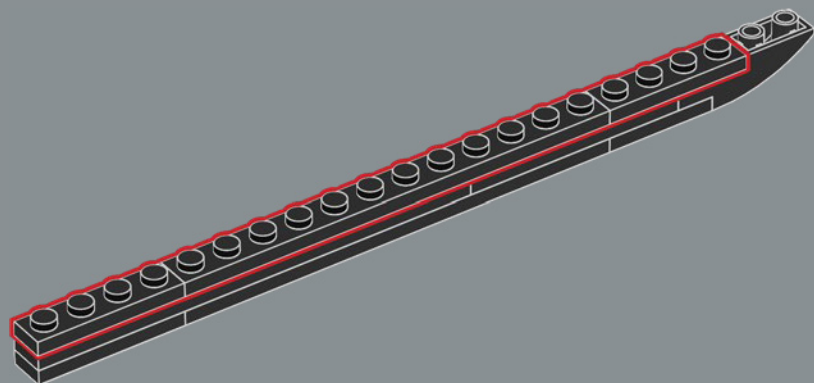

5

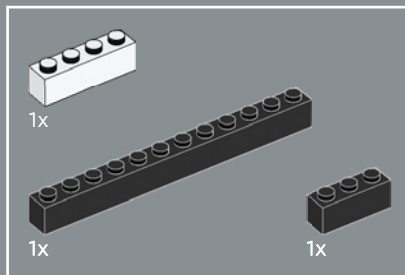
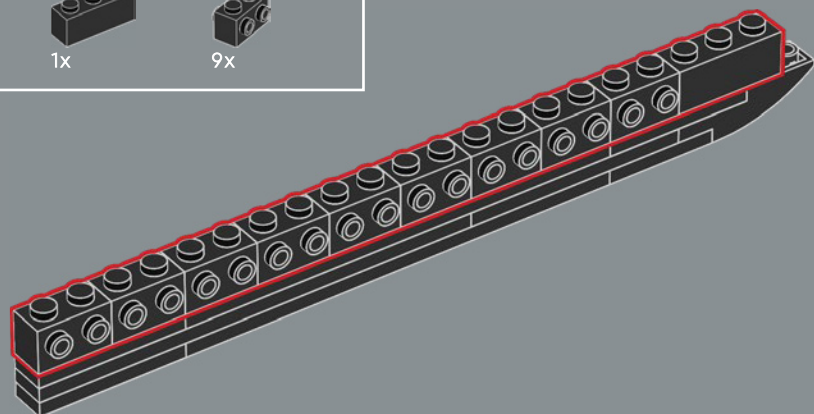

6

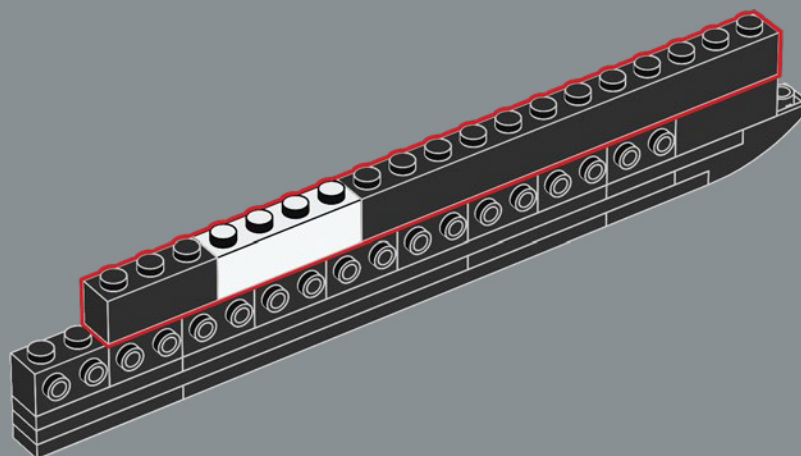

La quilla tiene solo un ladrillo de espesor para mantener el aspecto esbelto del barco, y los ladrillos de la sección delantera llevan las espigas hacia fuera. Esta técnica da al casco una silueta muy agradable a la vista.



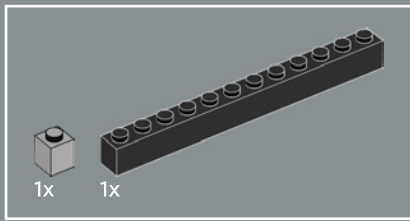

7

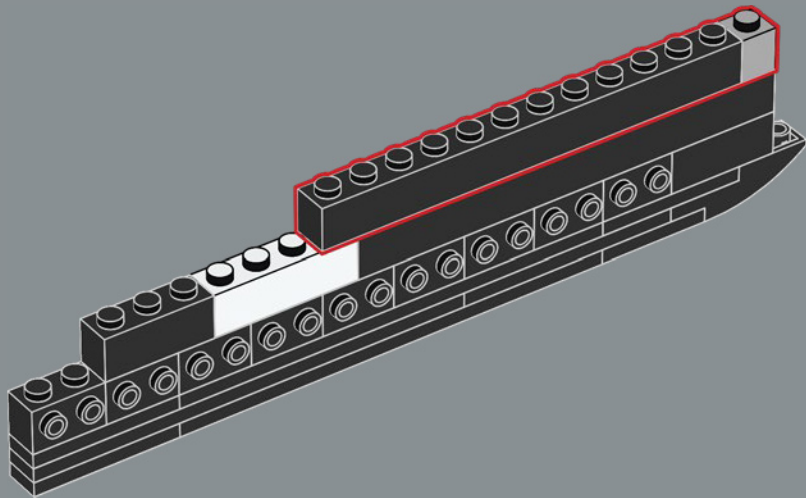

8

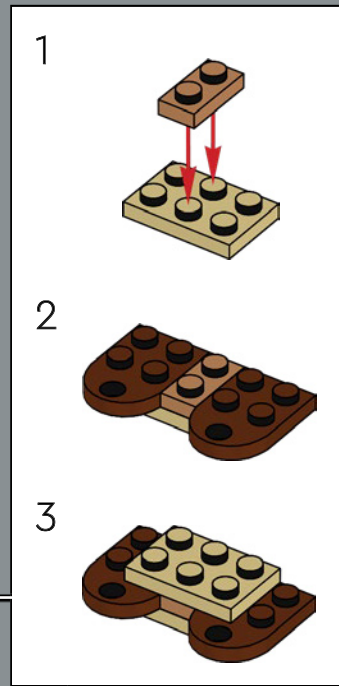
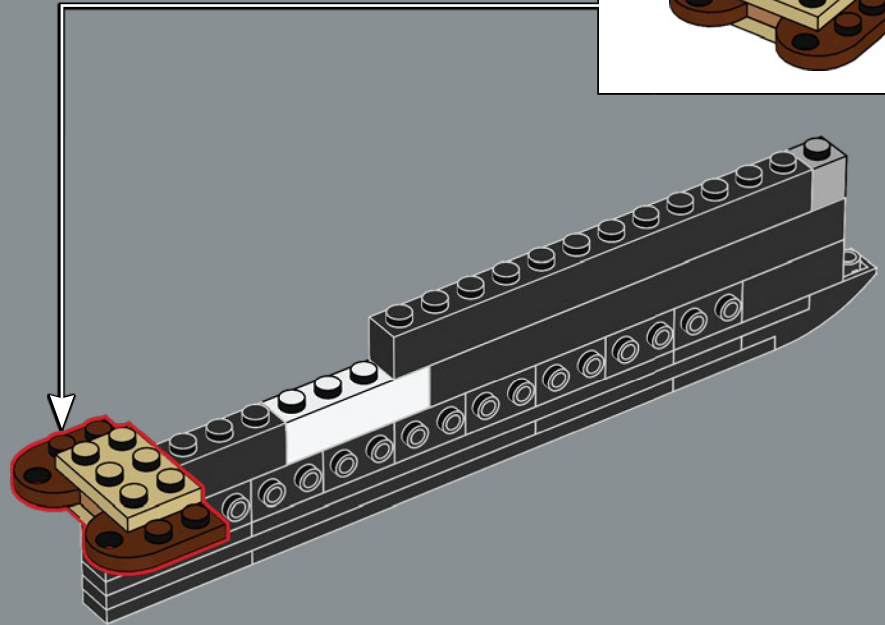

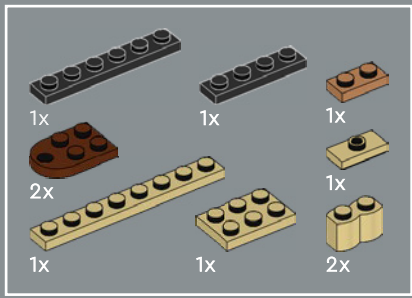

9

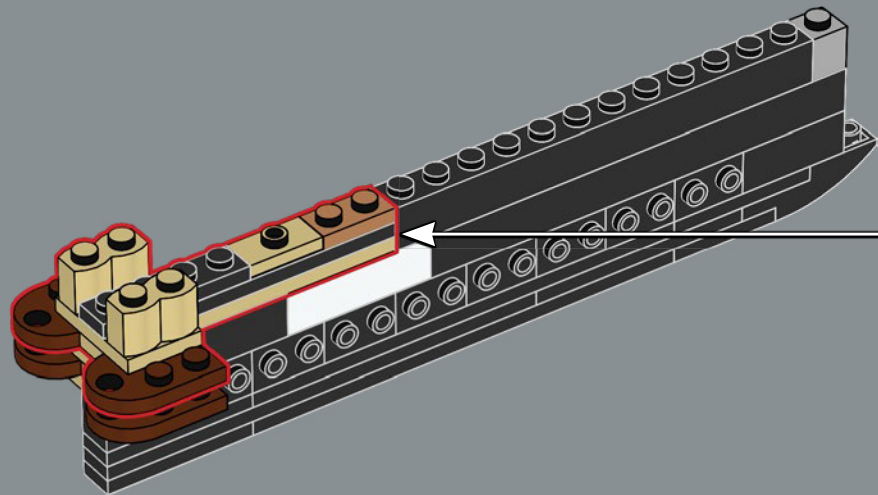
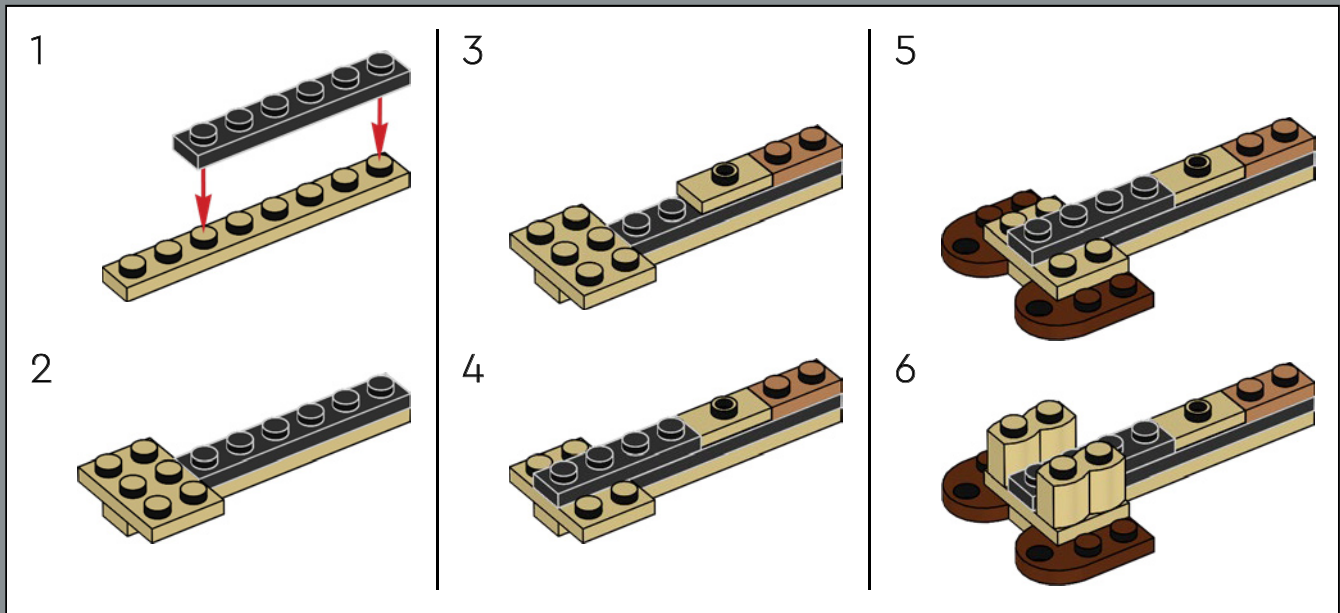

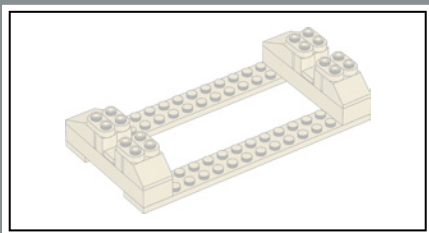

Como la quilla es muy estrecha, puedes usar el "soporte auxiliar" de color más claro para mantener estable el modelo durante la construcción.

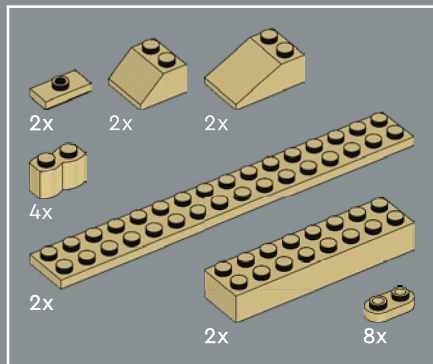

10

1

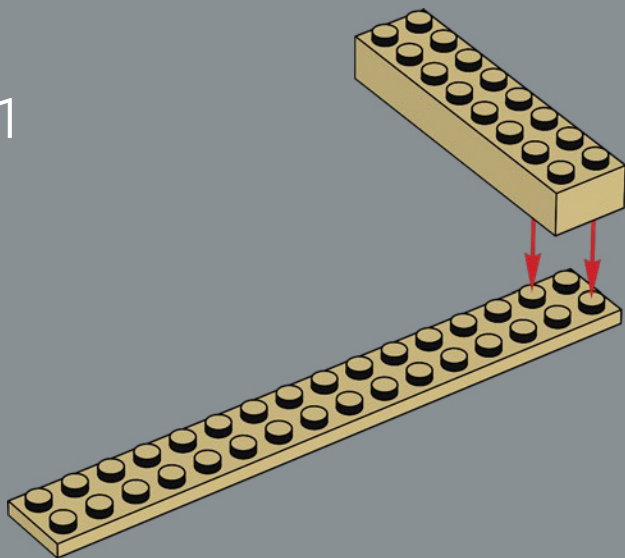

2

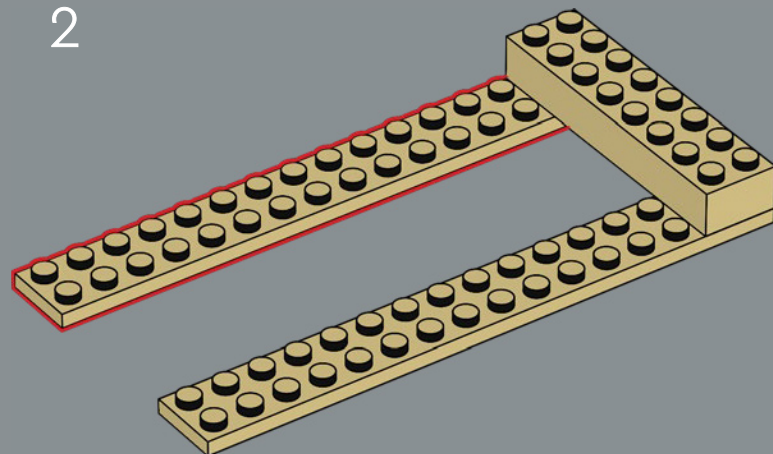

3

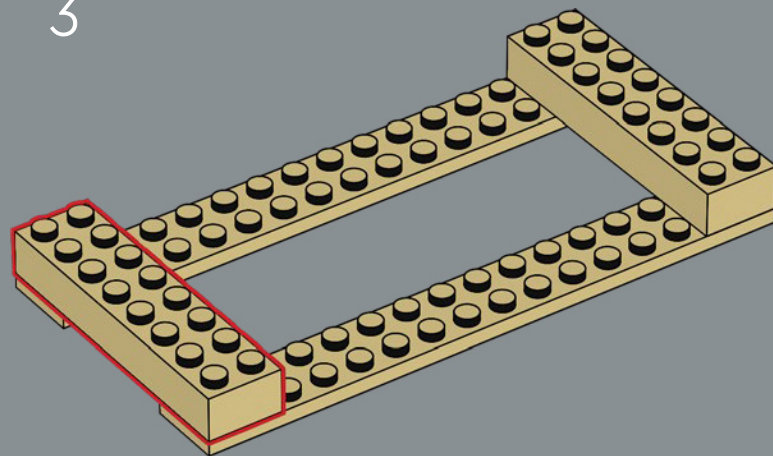

4

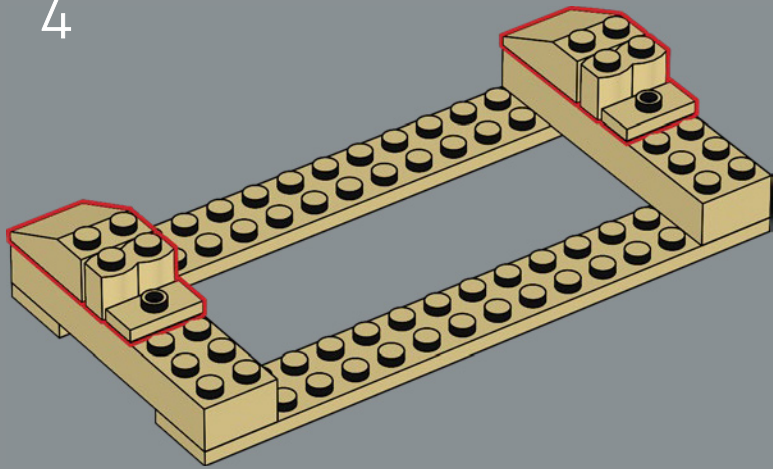

6

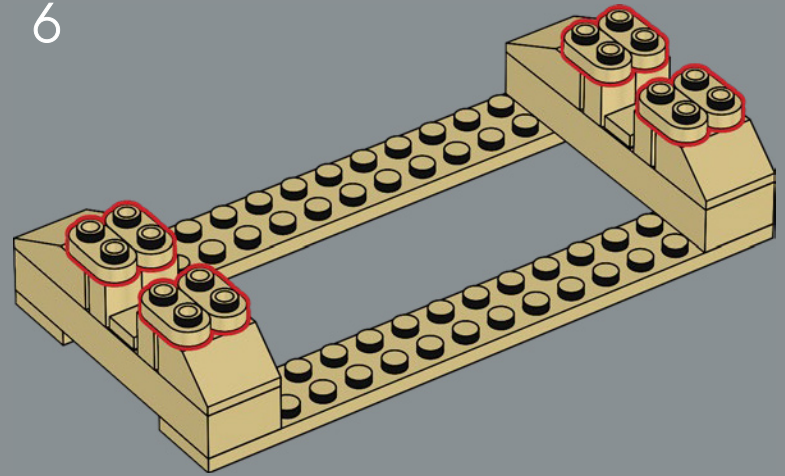

5

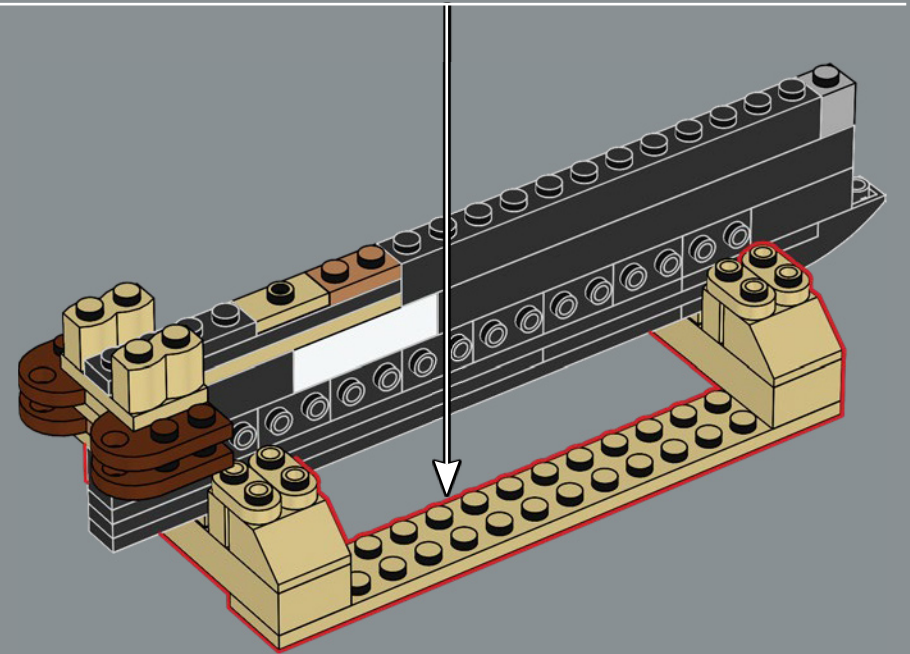
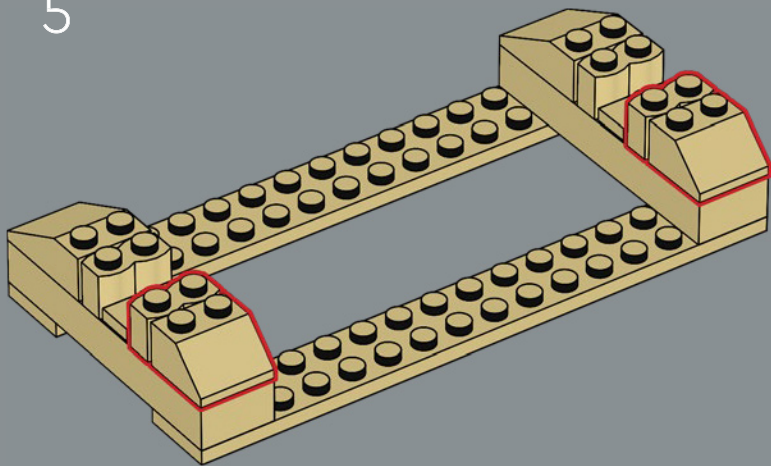

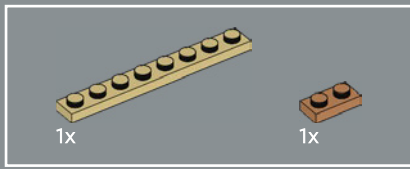

11

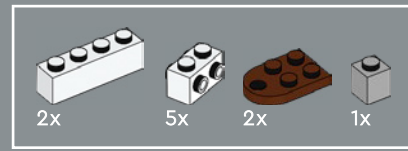
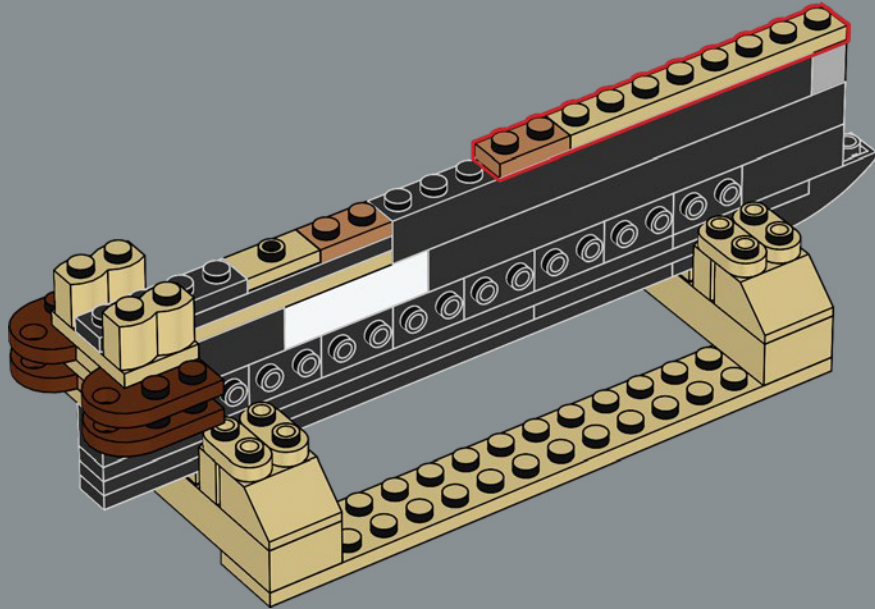

12

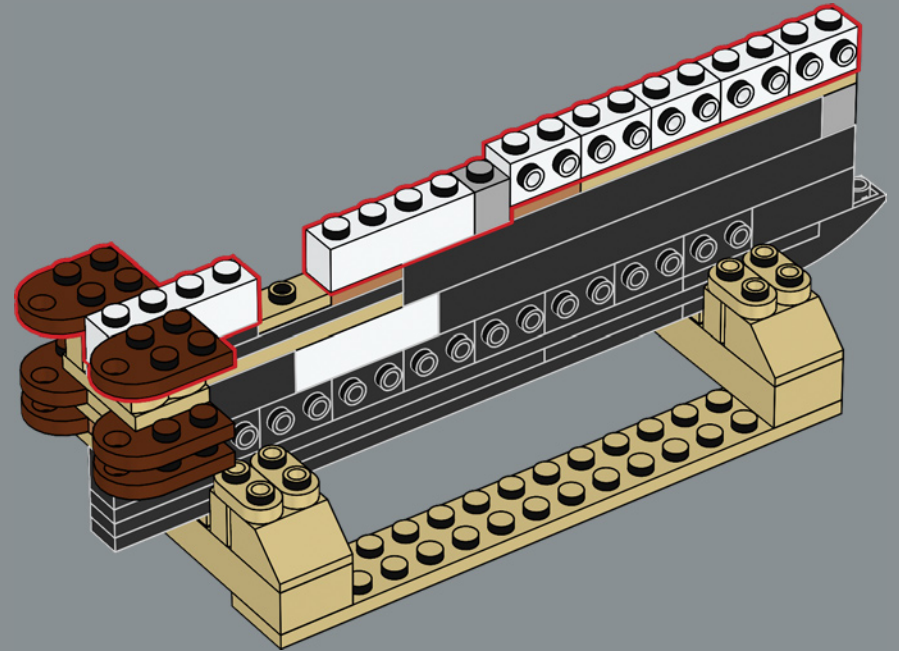



13

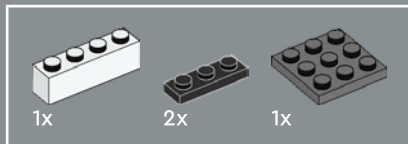
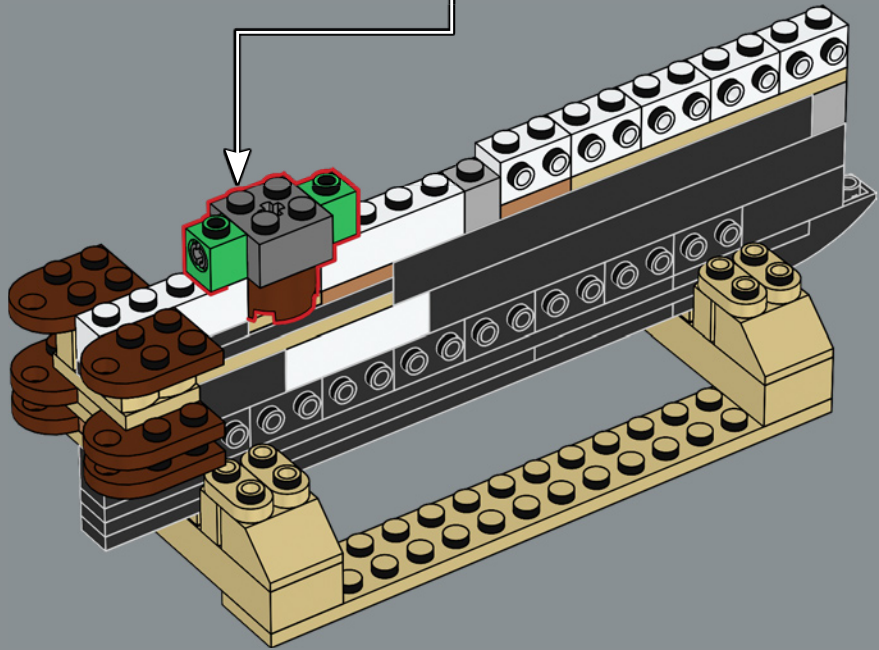
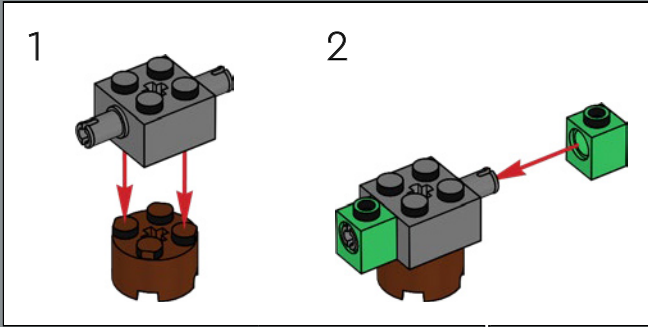

14

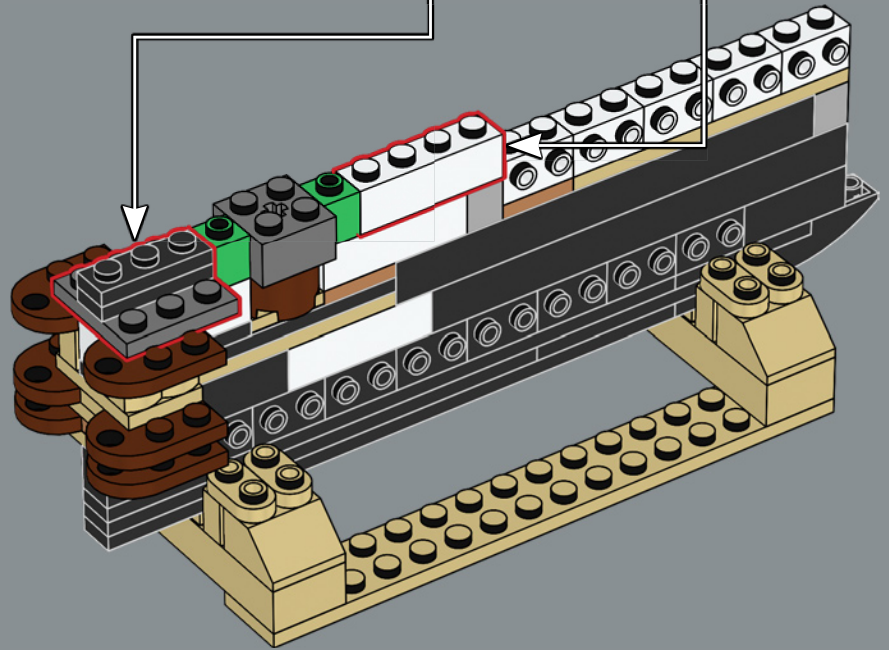
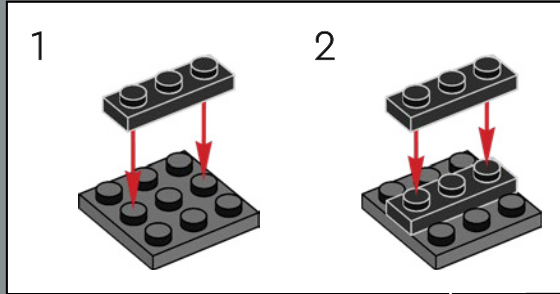

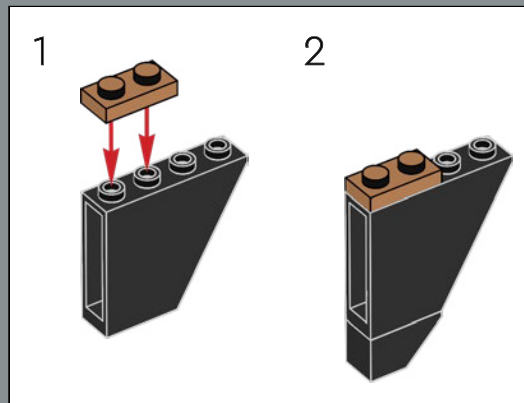
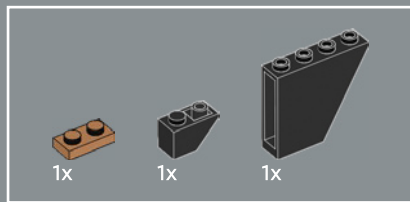

15

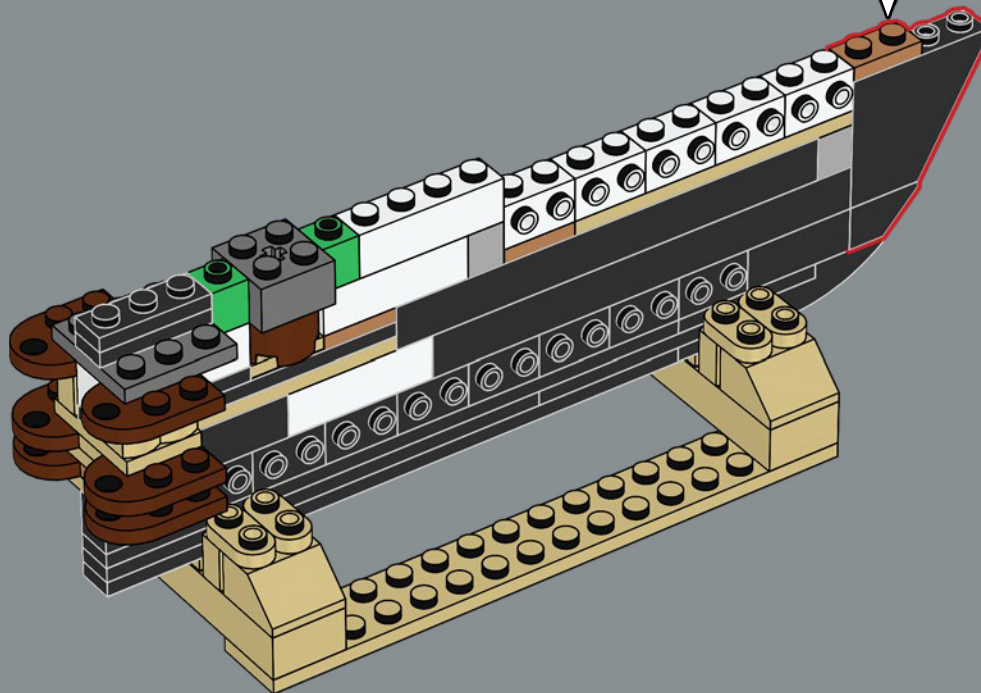

El frente del casco del barco estaba revestido de láminas metálicas para proteger la quilla de madera de los hielos polares. En el modelo, esta sección se recreó con un inusual ladrillo con pendiente invertida 1x4x3.

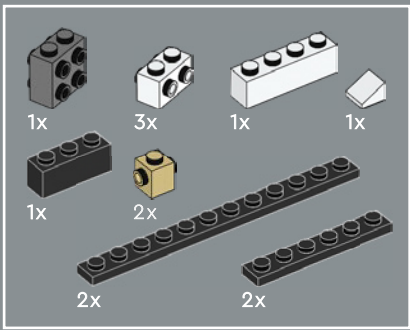

16

1

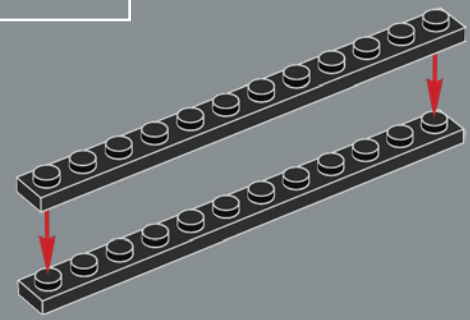

2

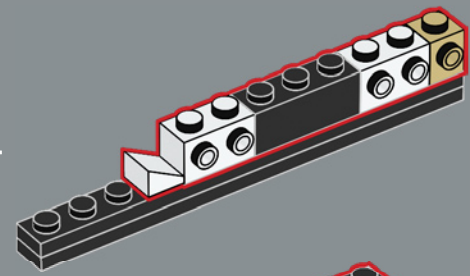

3

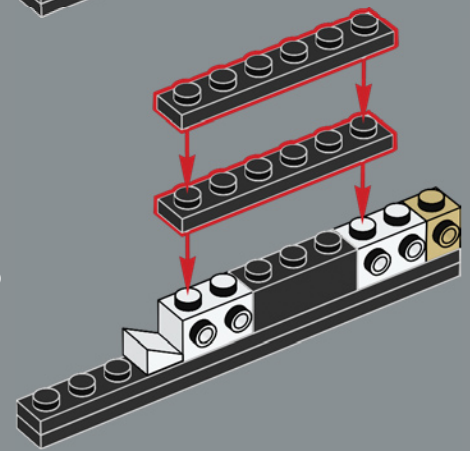

4

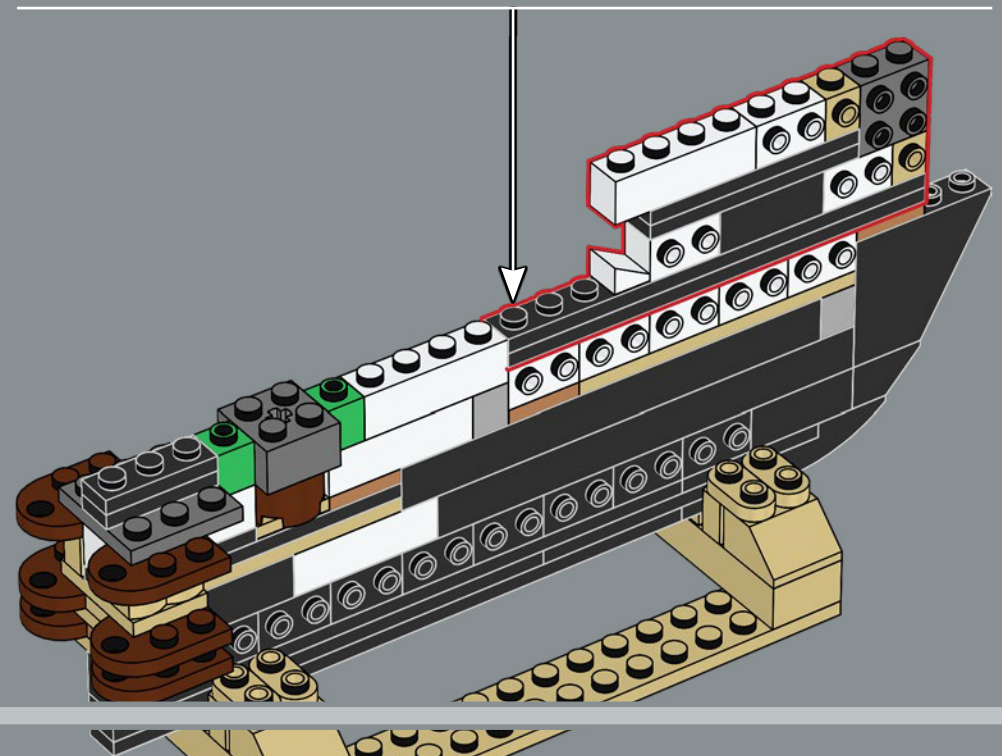
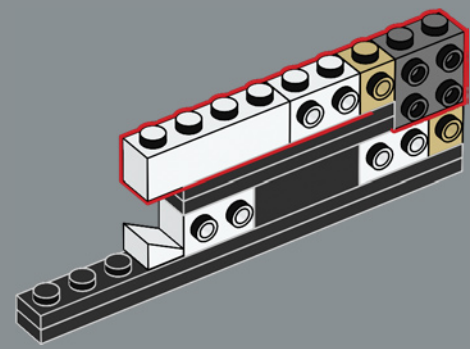

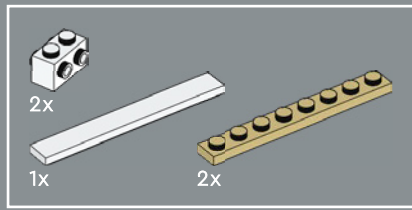

17

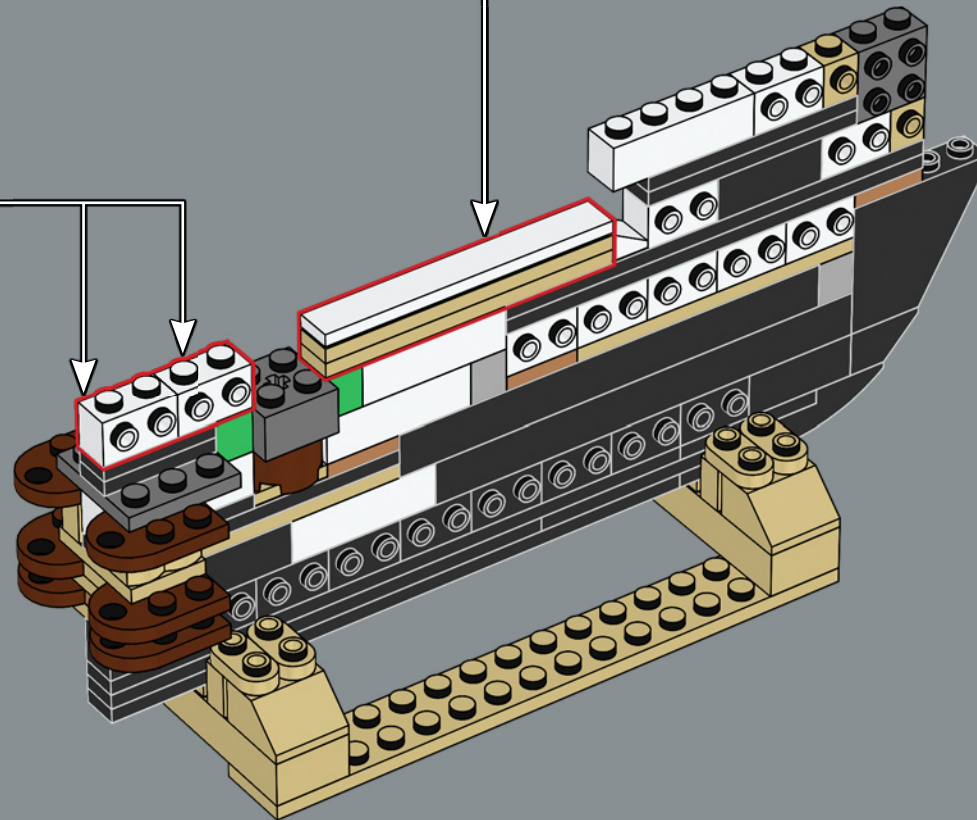
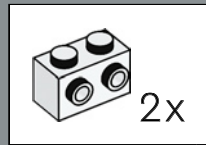
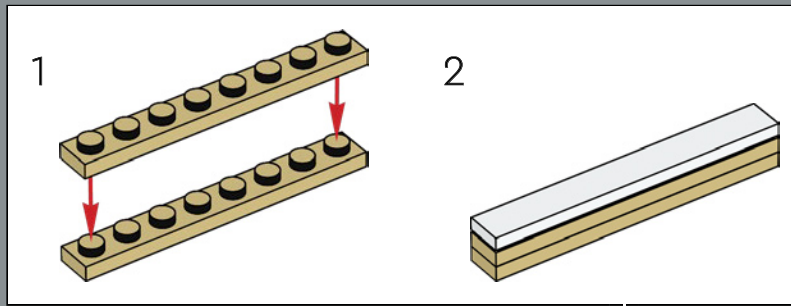

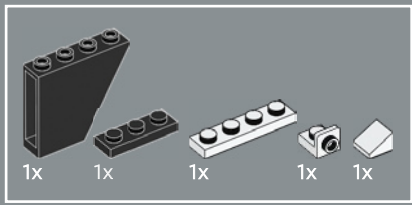

18

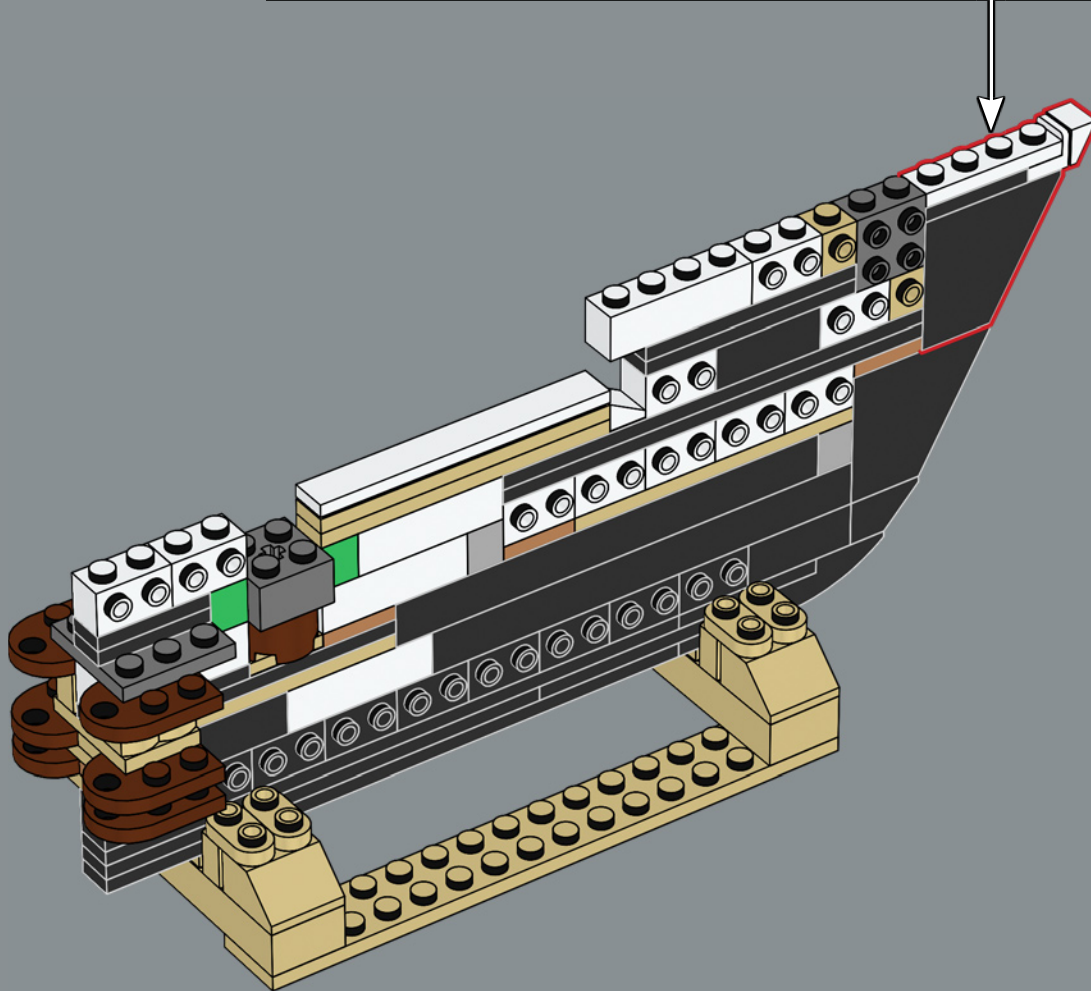
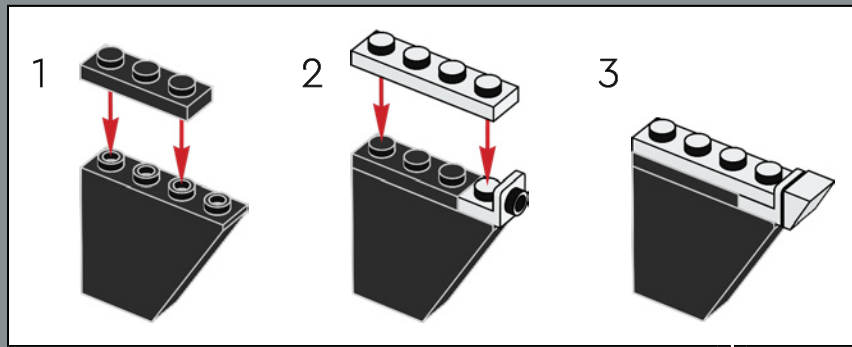

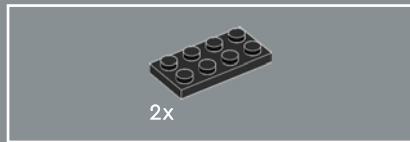
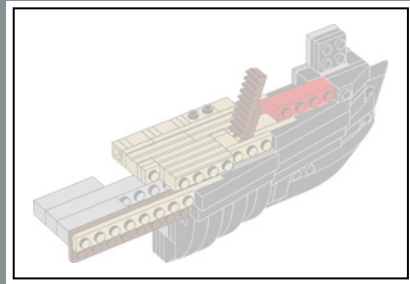

19

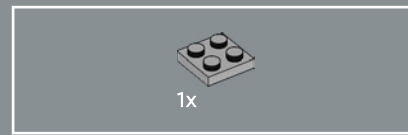
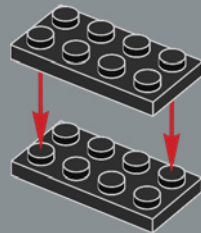

20

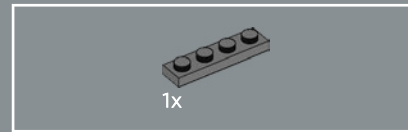
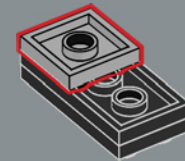

21

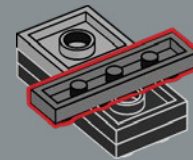

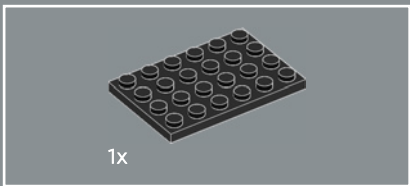

22

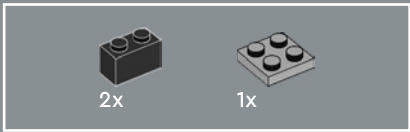
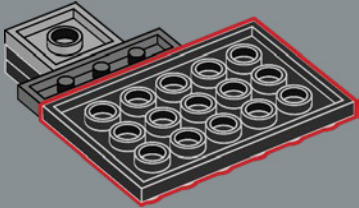

23

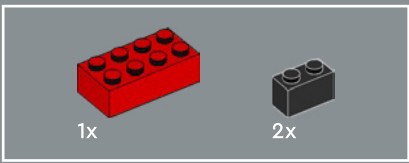
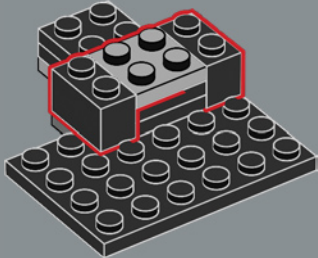

24

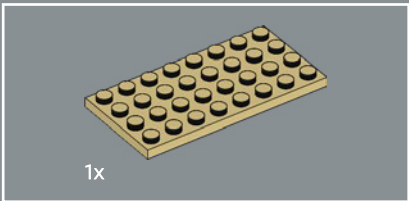
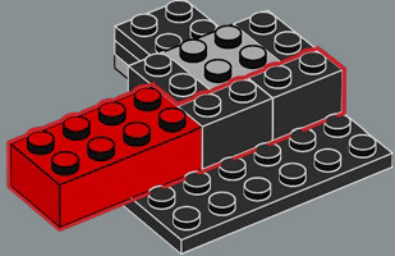

25

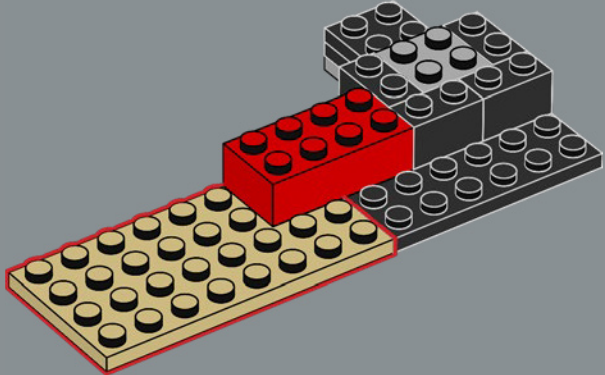

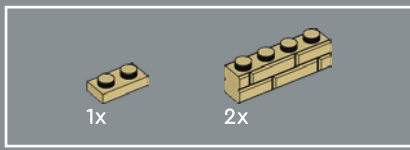

26

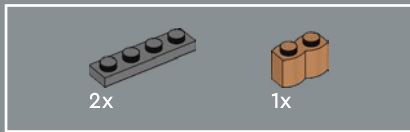
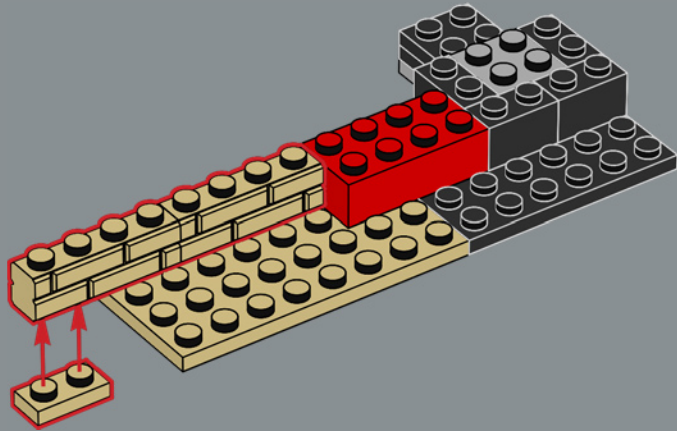

27

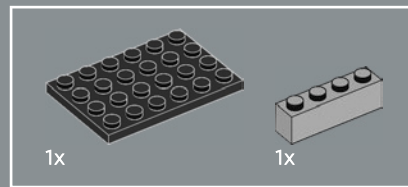
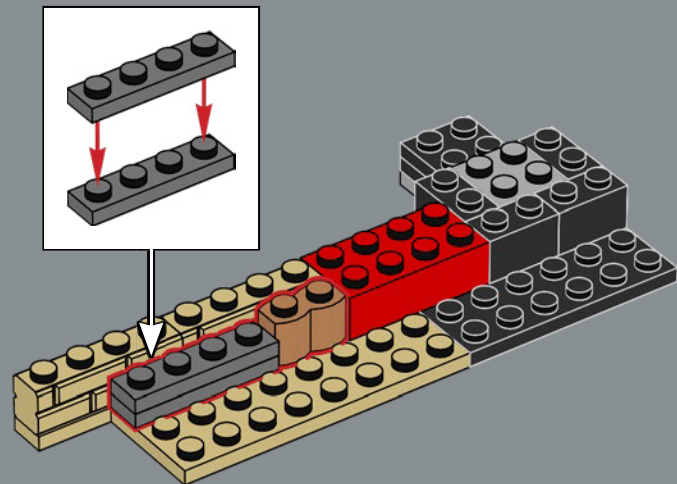

28

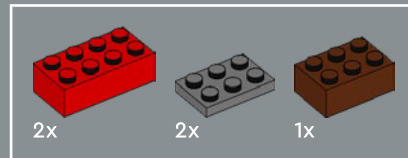
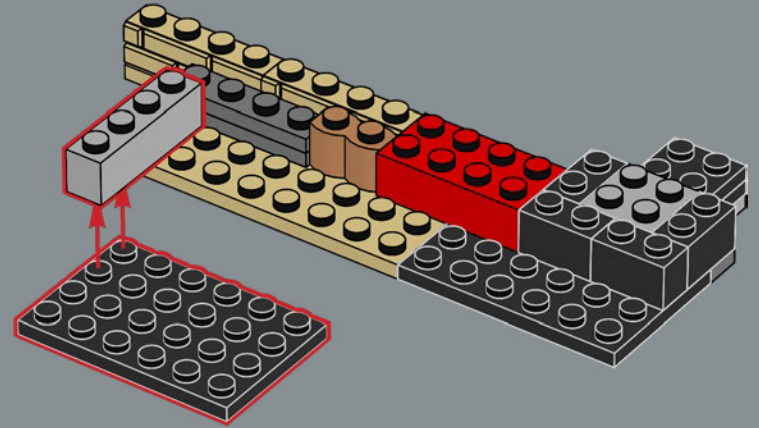

29

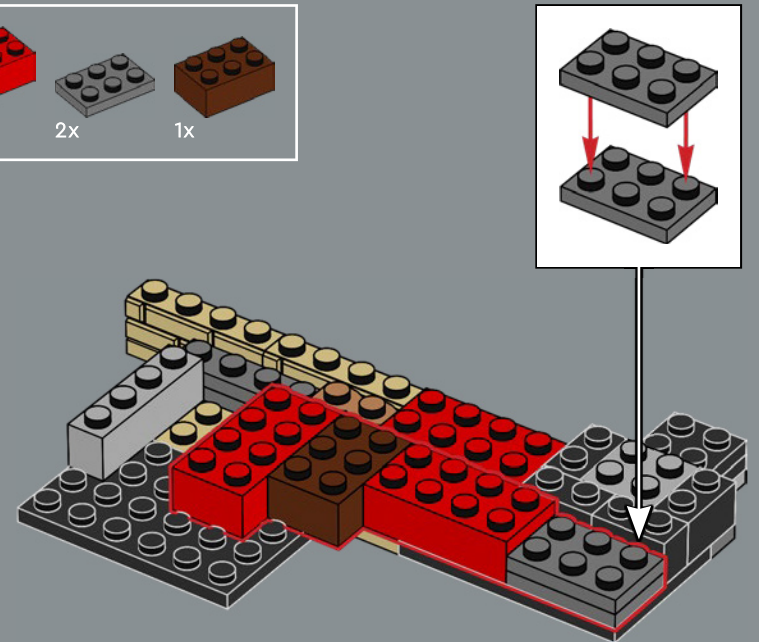

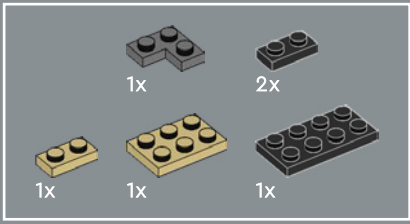

30

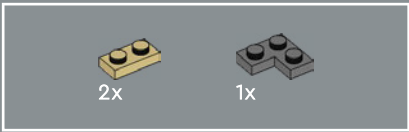
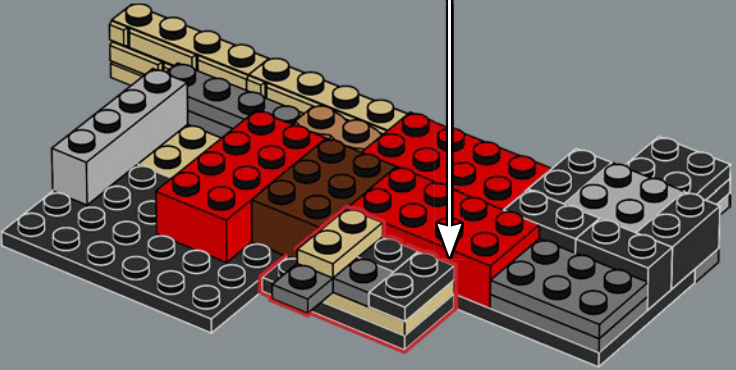
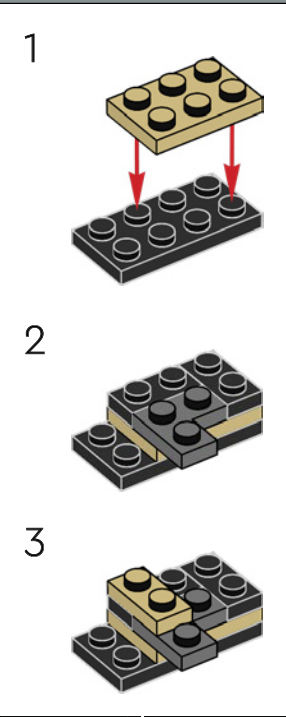

31

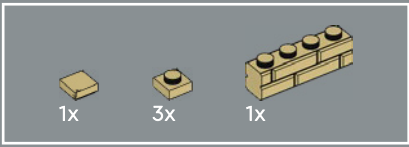
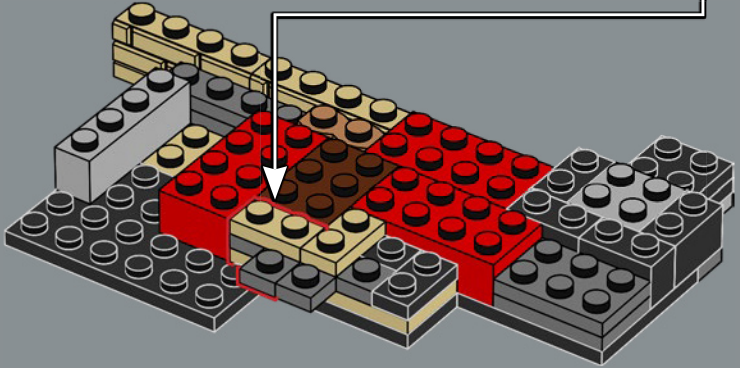
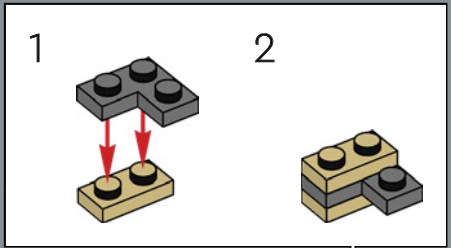

32

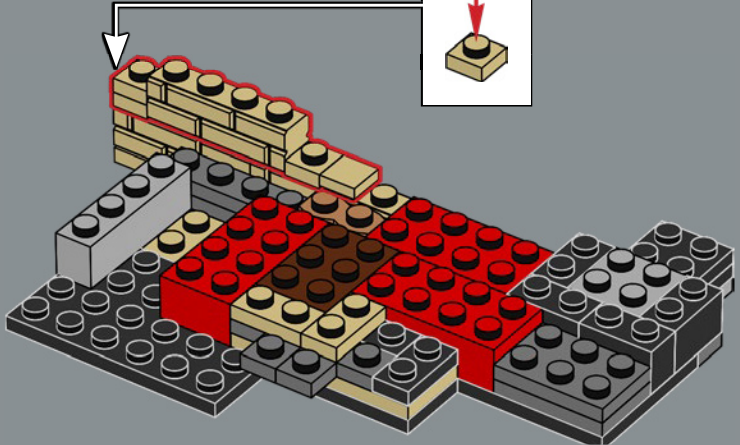
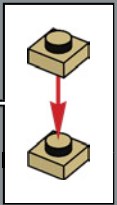

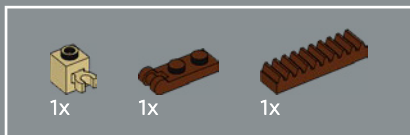

33

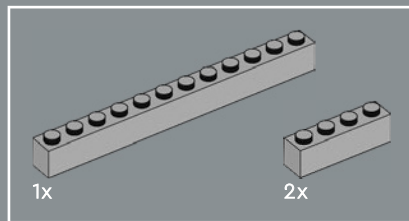
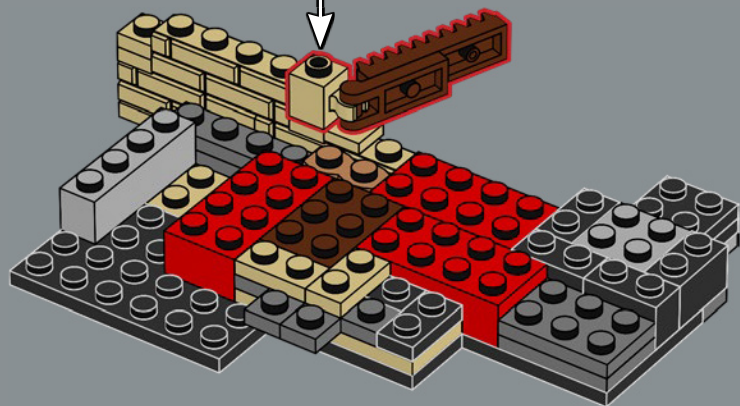
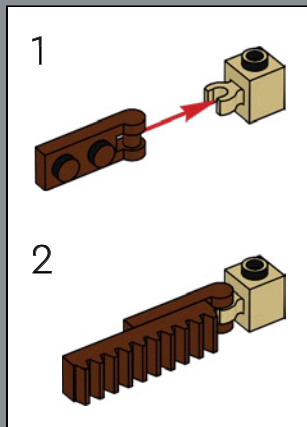

34

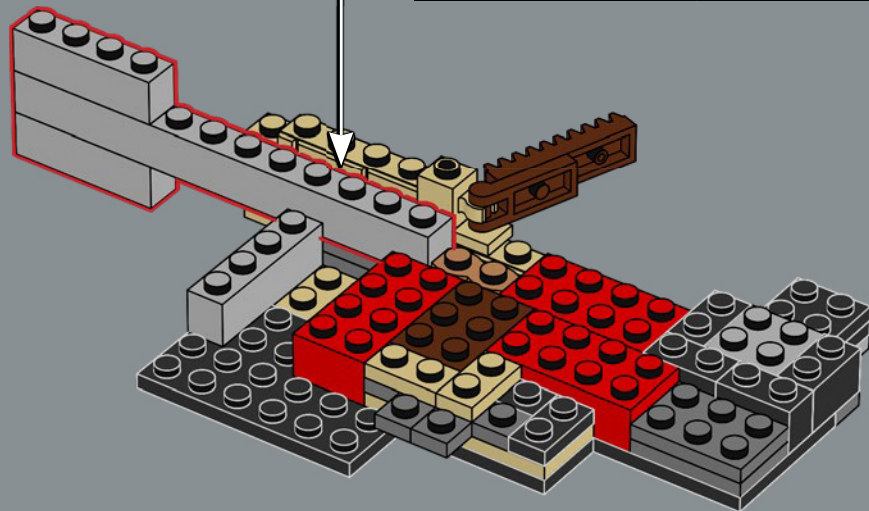
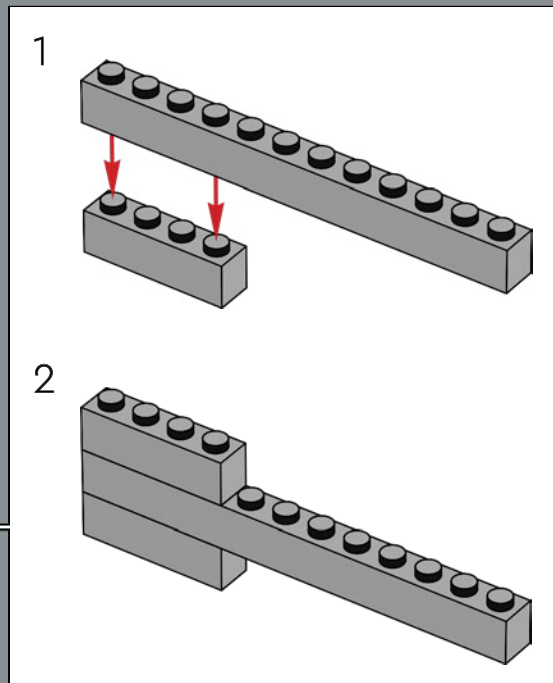

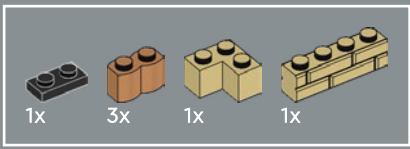

35

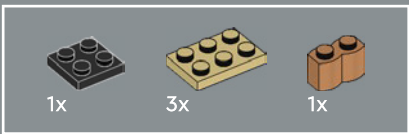
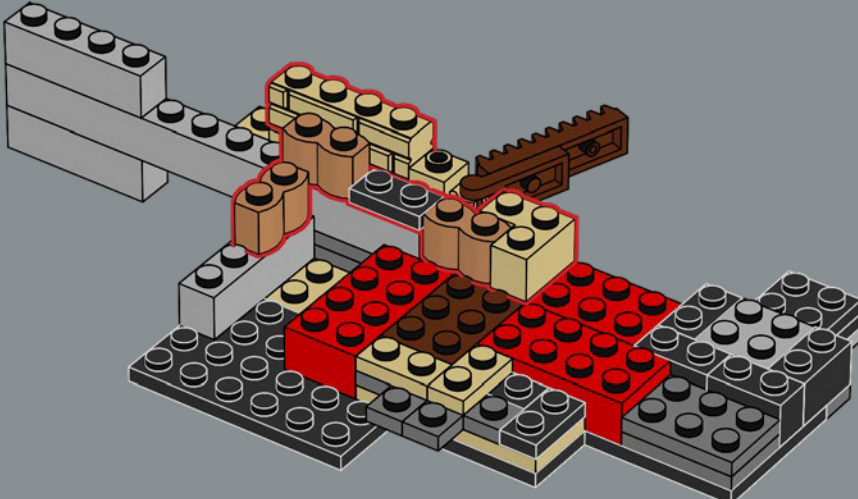

36

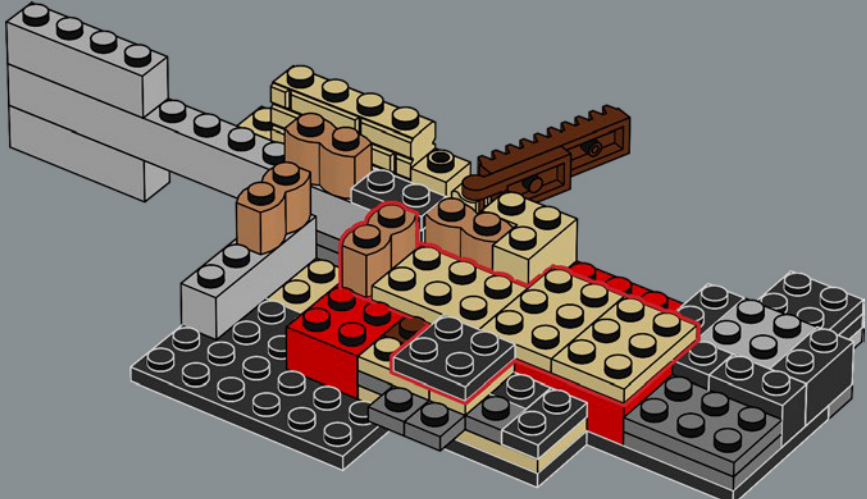

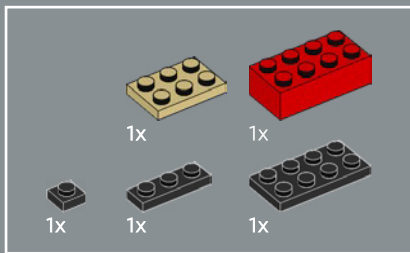

37

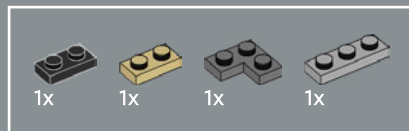
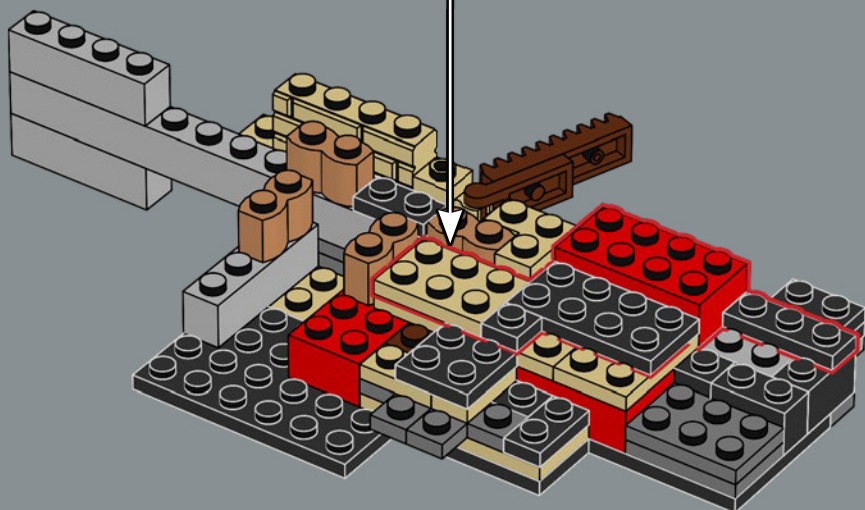
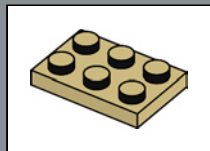

38

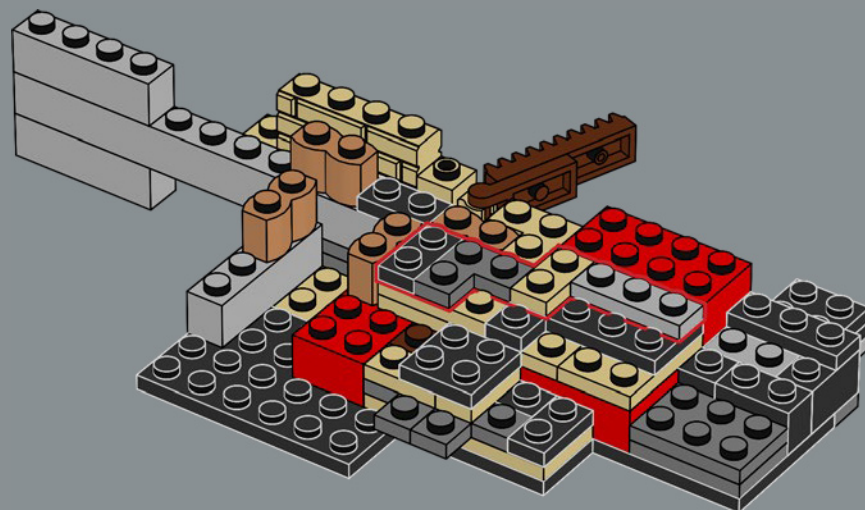

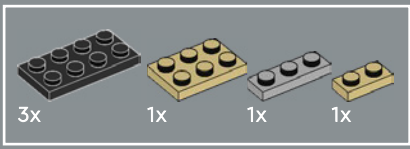

39

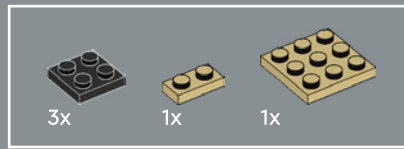
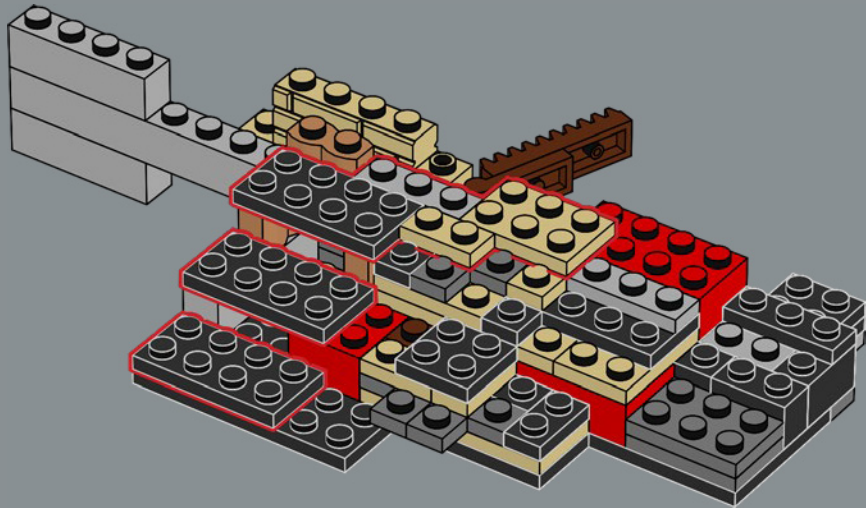

40

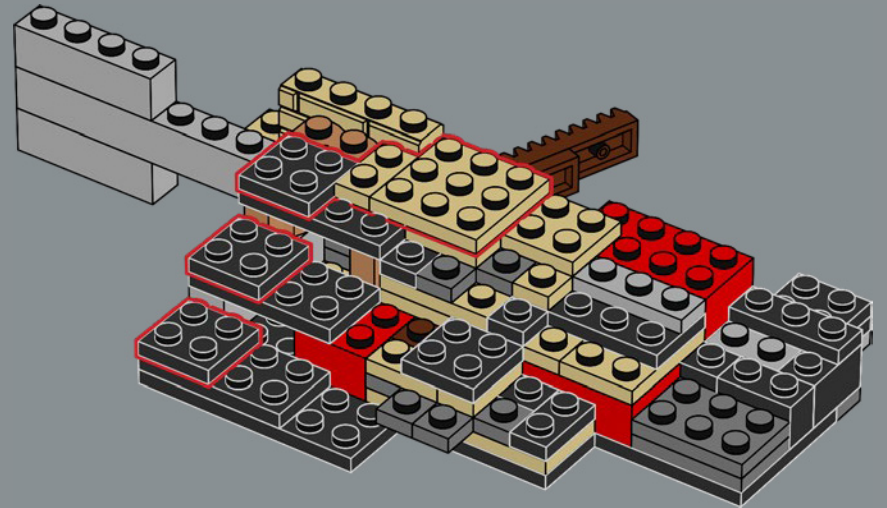

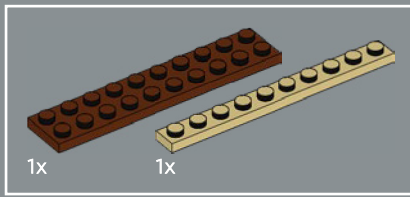

41

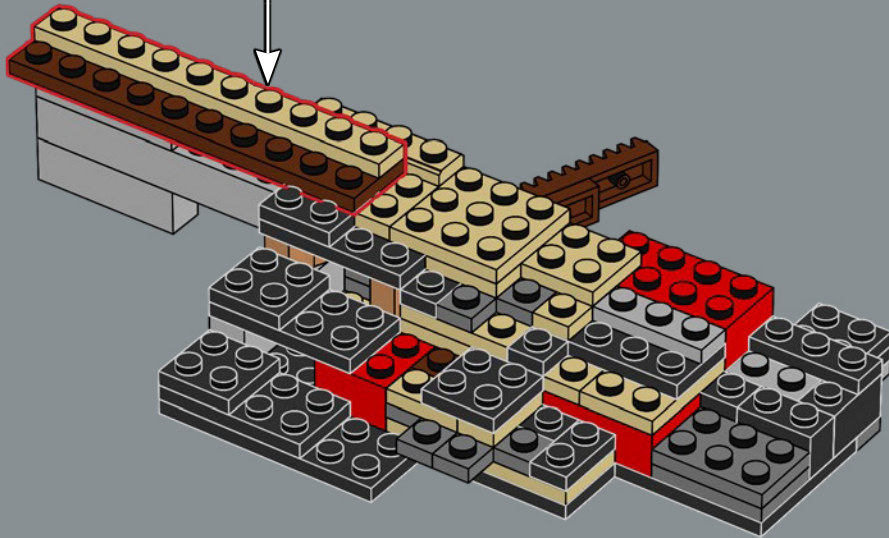
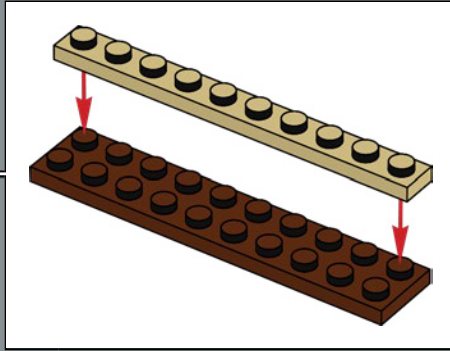

42

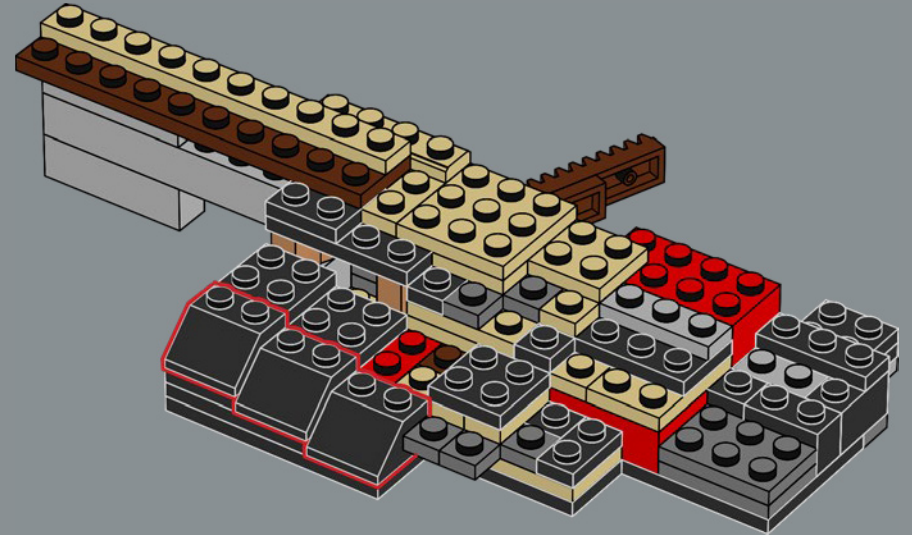



43

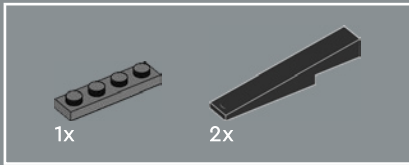
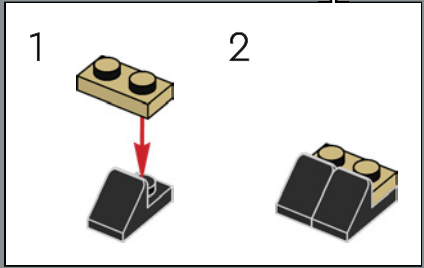
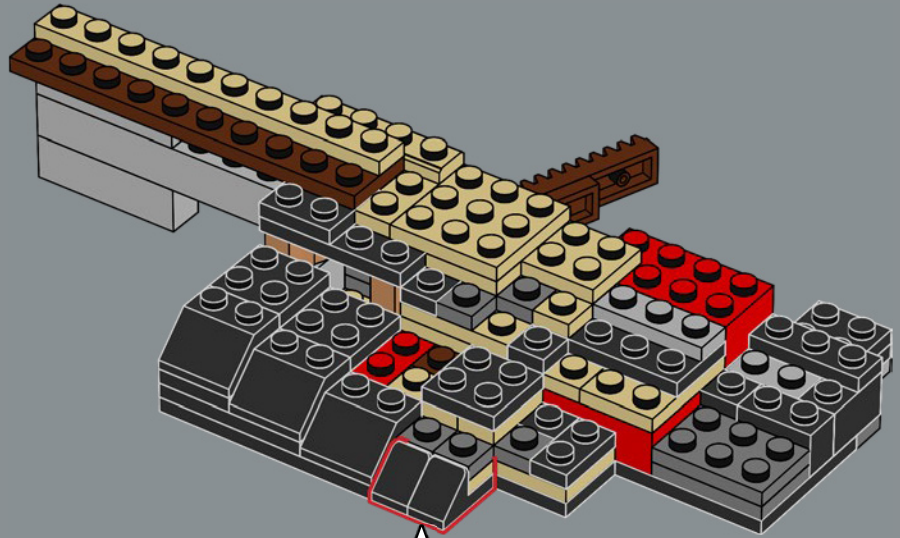

44

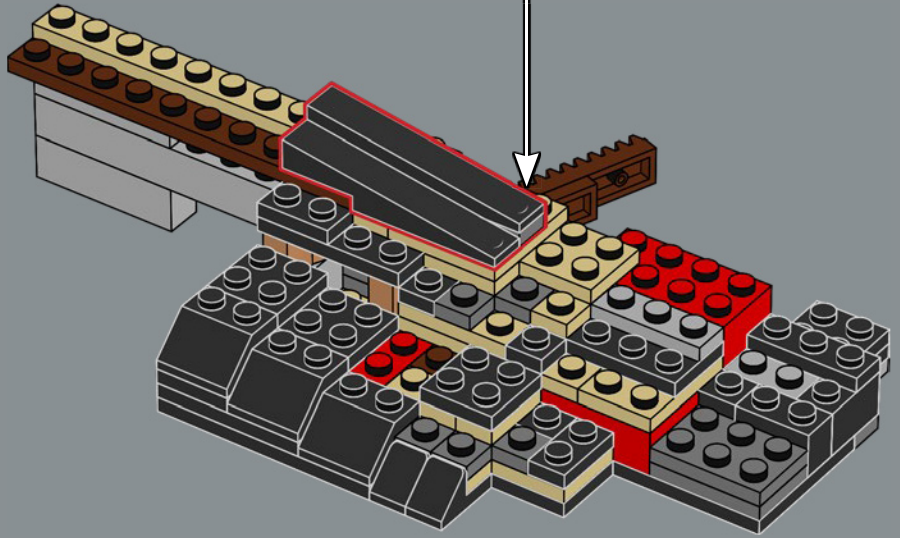
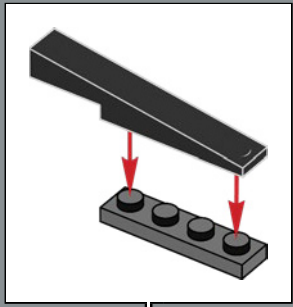



45

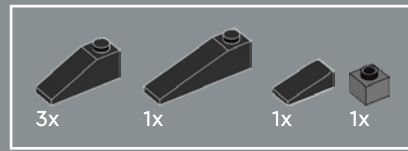
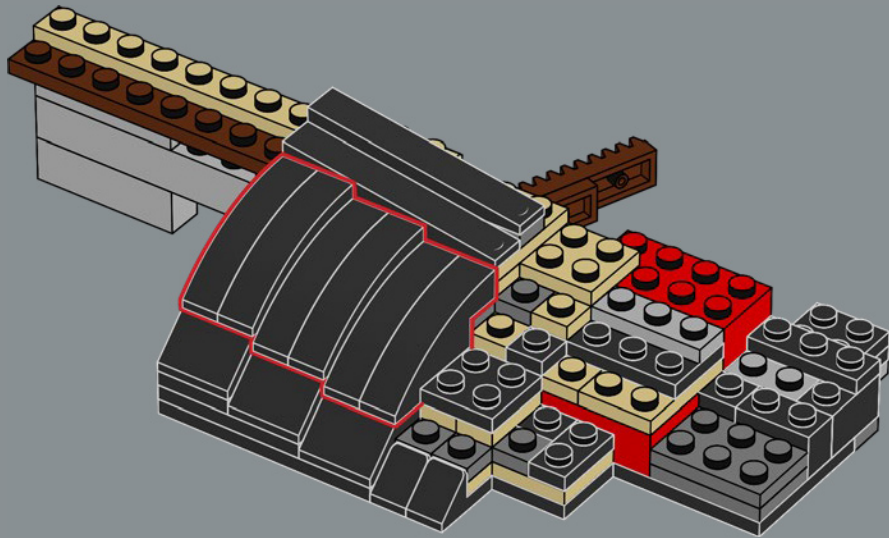

46

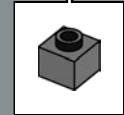
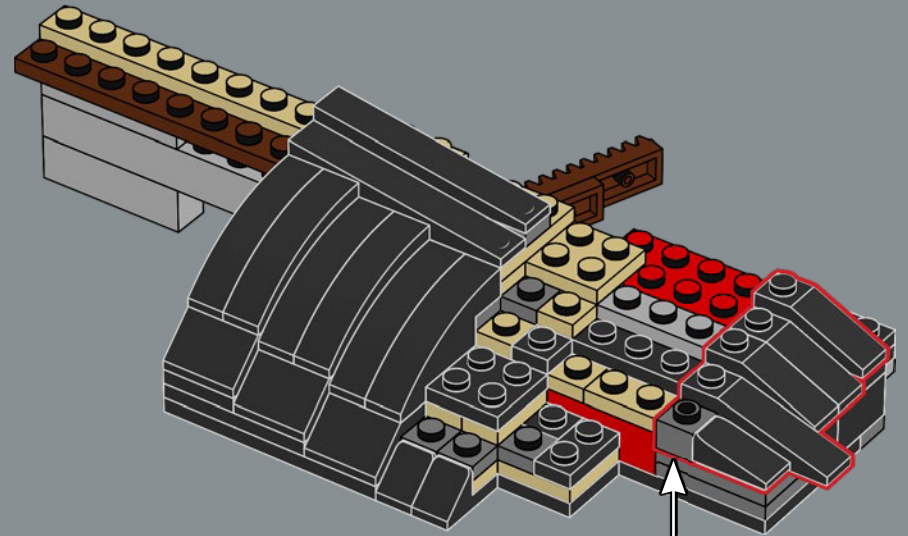

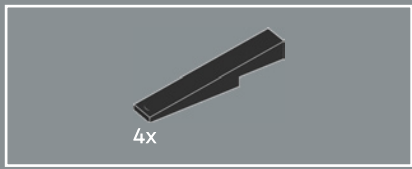

47

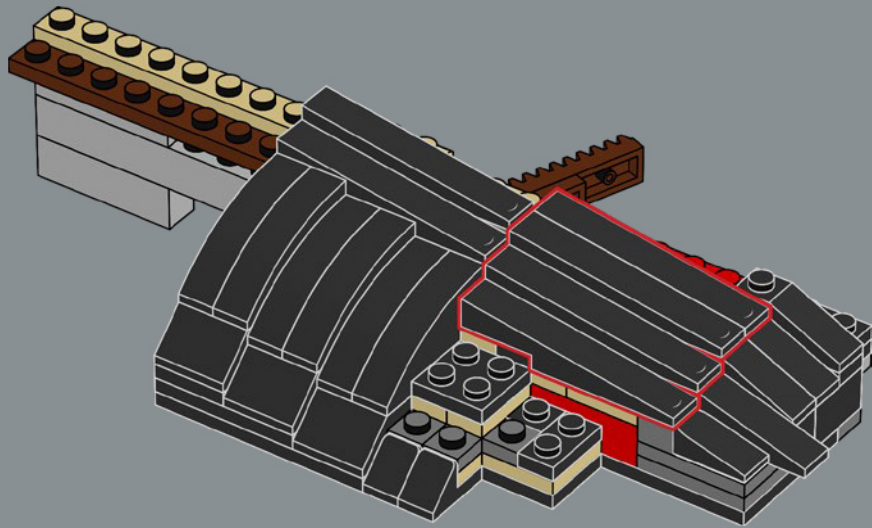

48

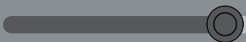
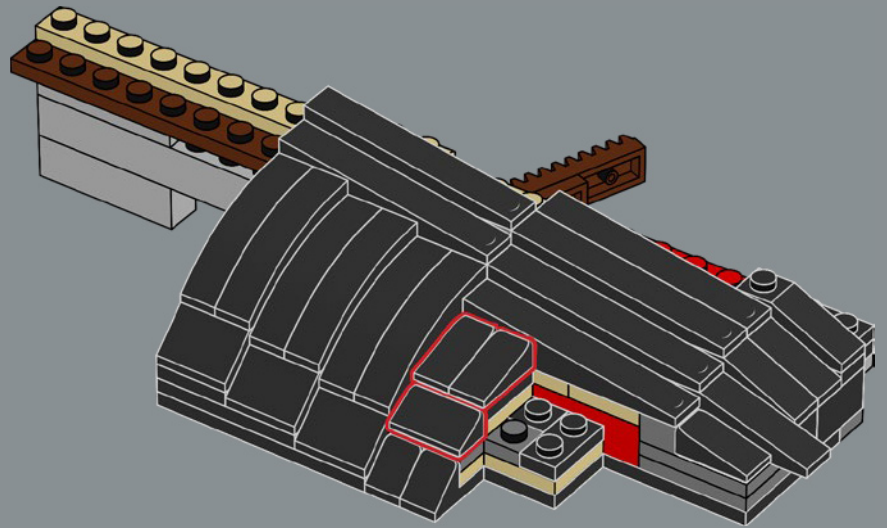

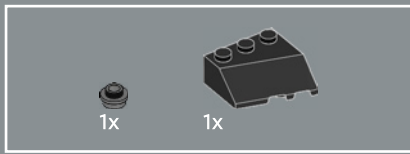

49

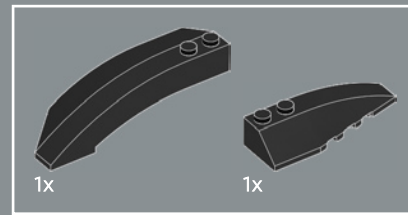
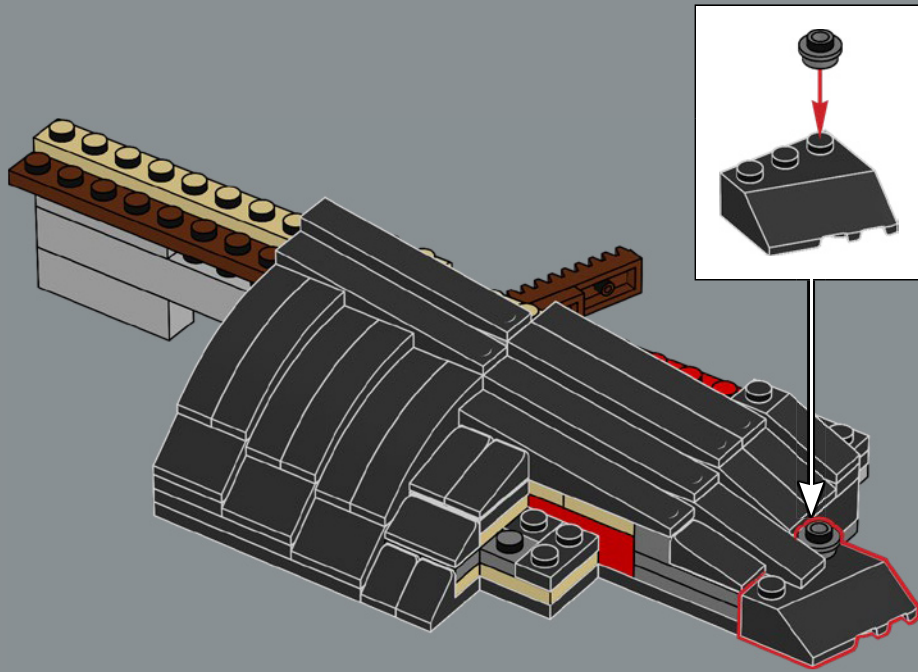

50

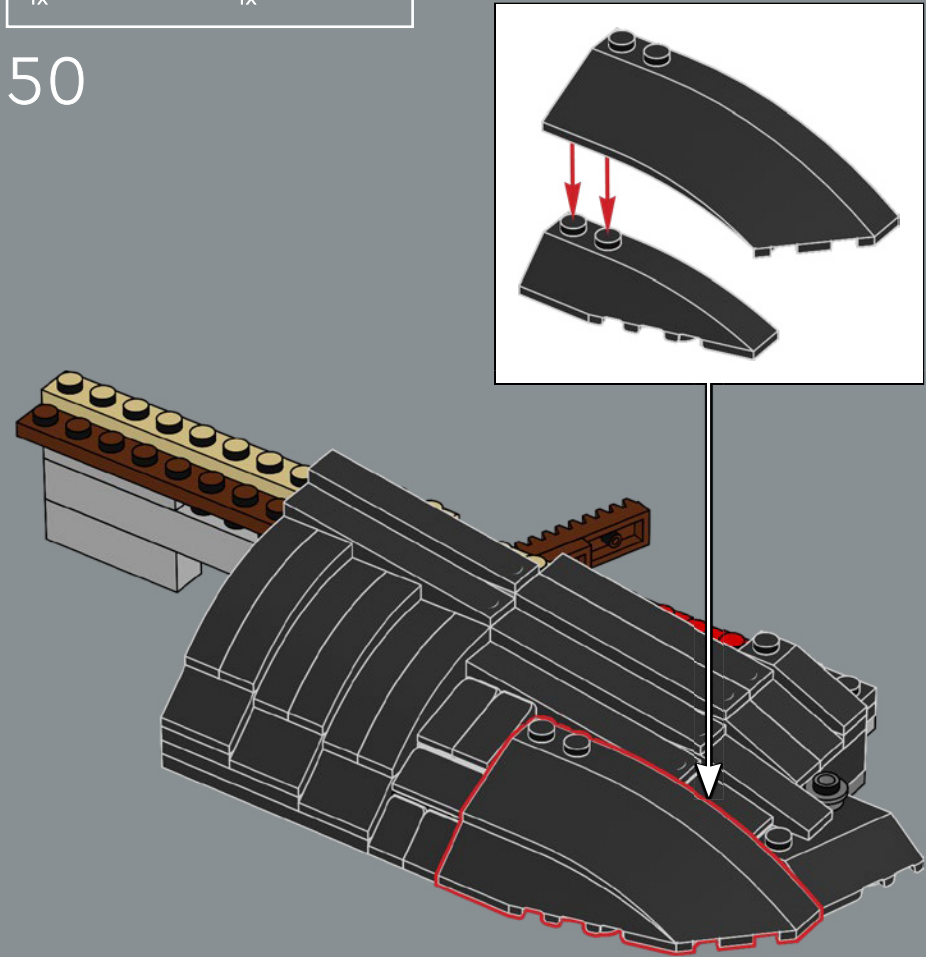



51

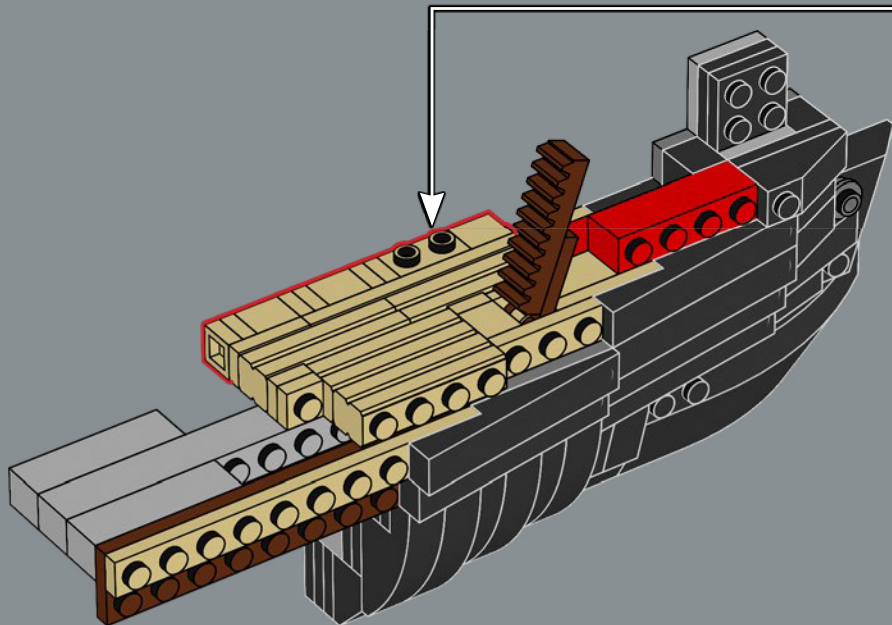
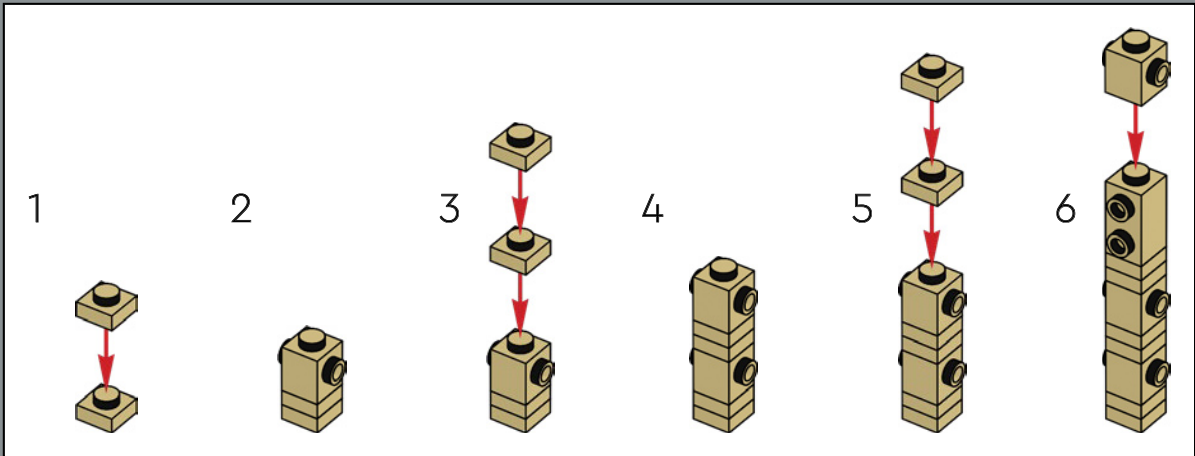

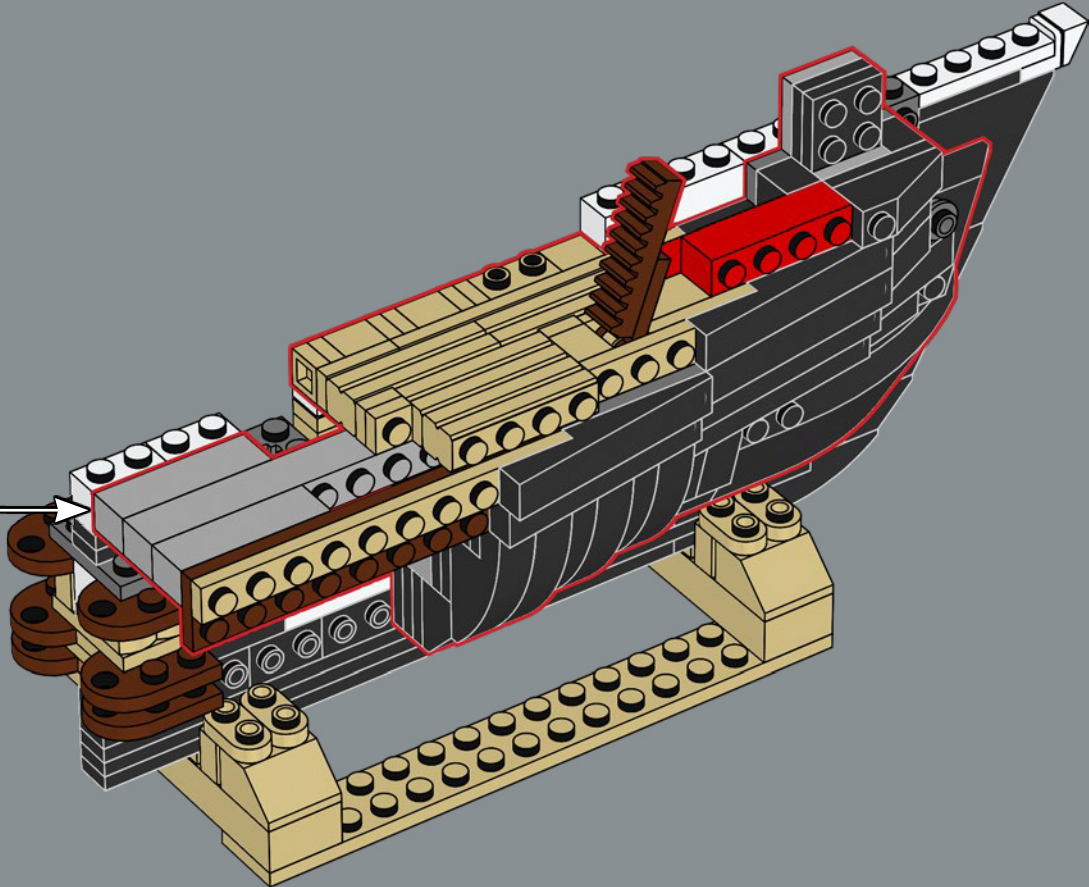

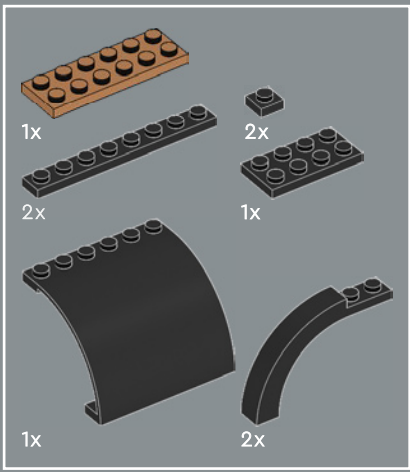

53

1

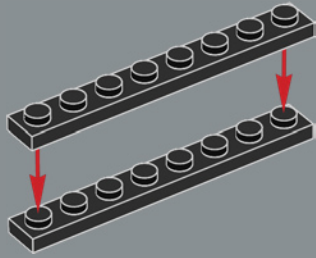

2

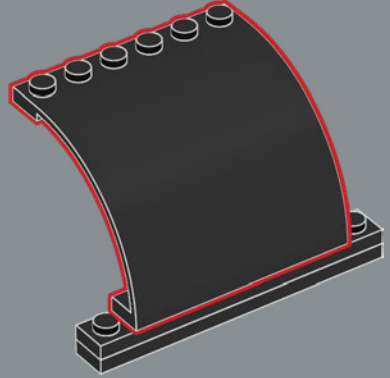

3

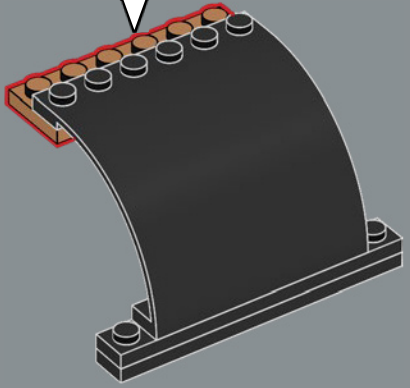
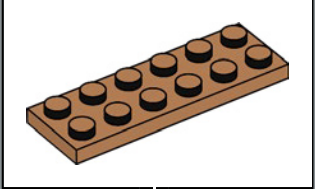

4

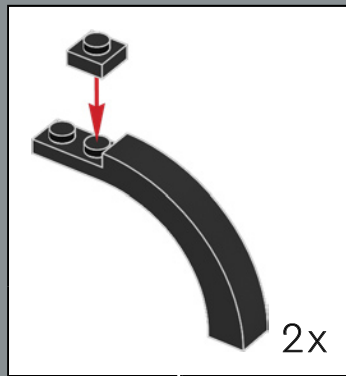
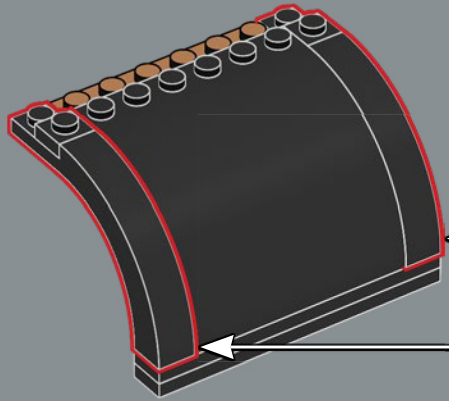

5

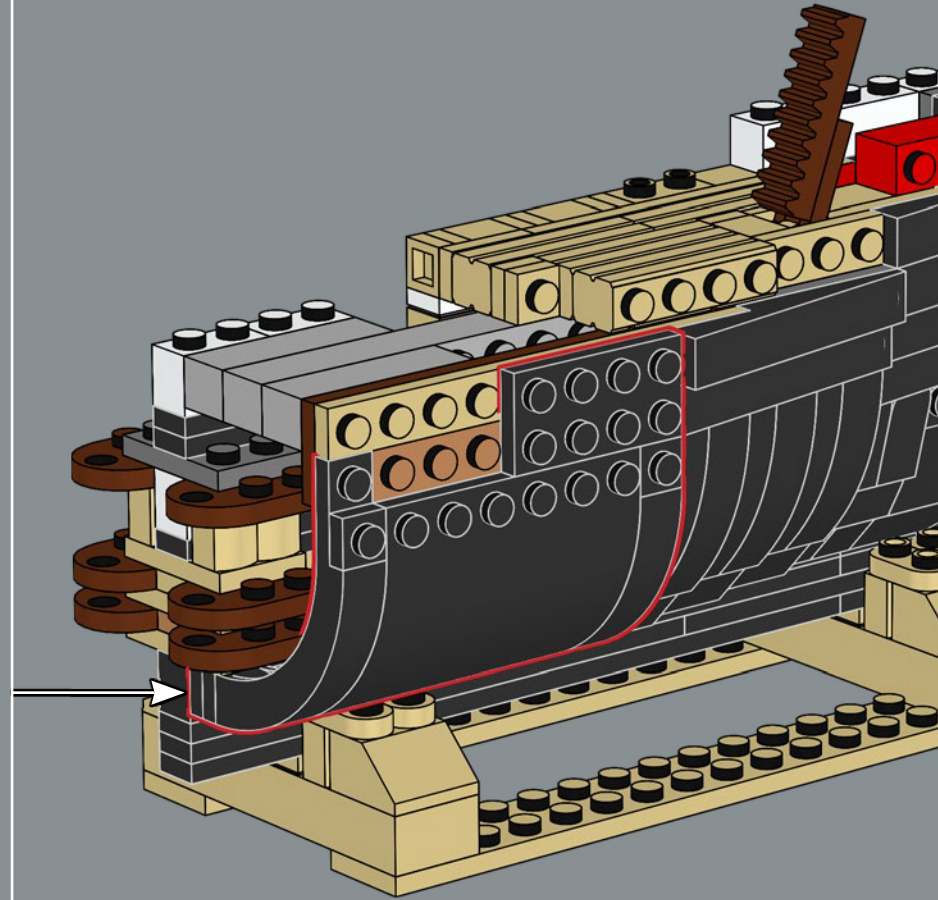
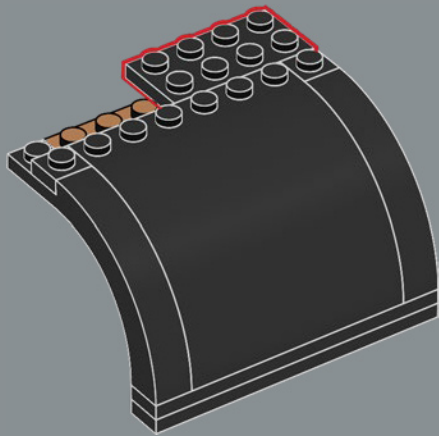

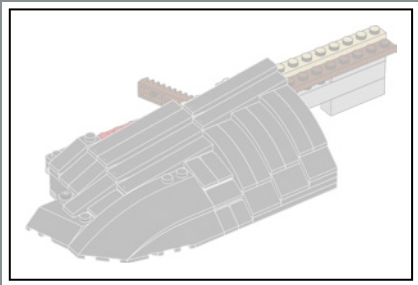

54

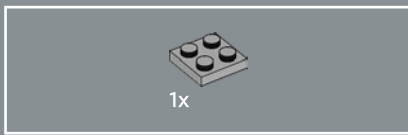
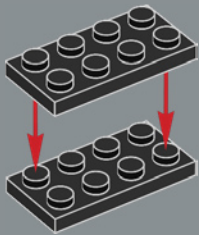

55

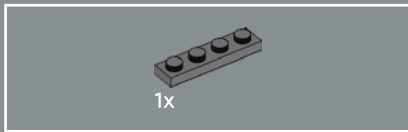
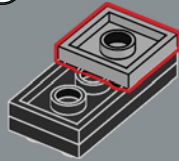

56

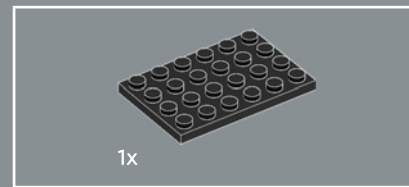
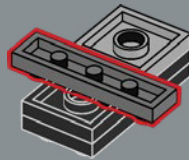

57

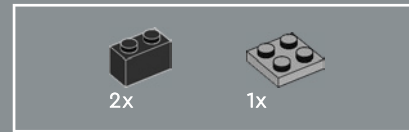
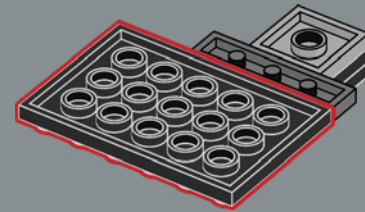

58

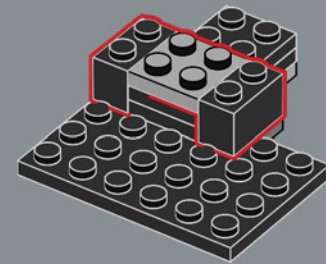

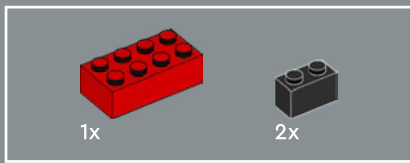

59

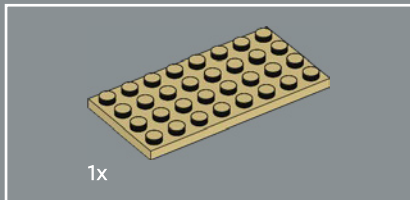
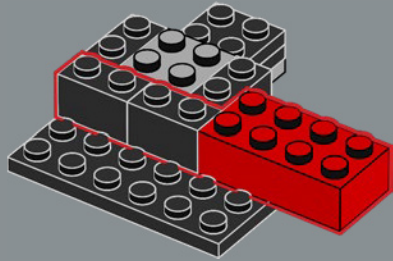

60

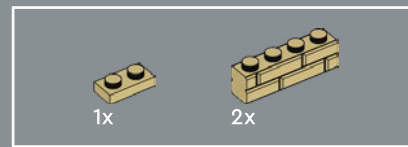
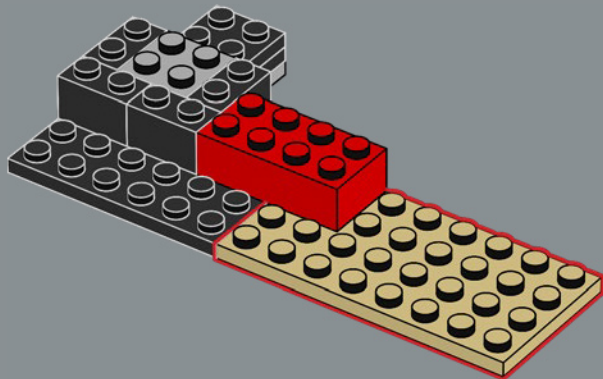

61

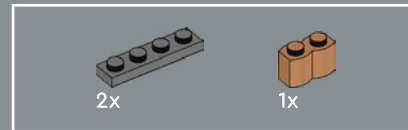
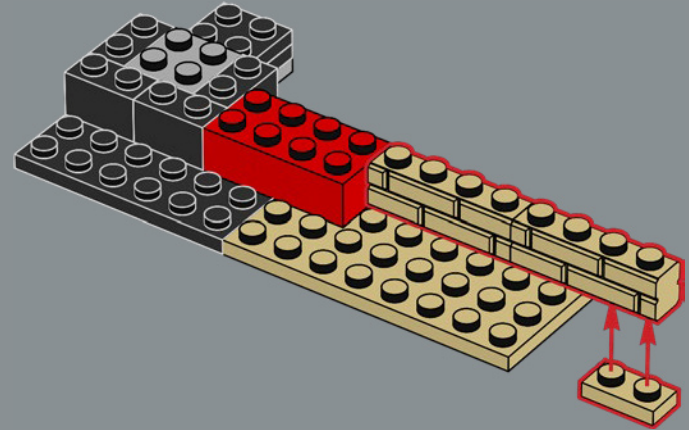

62

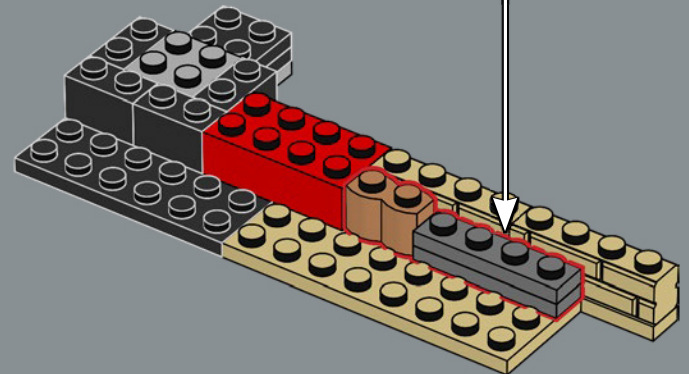
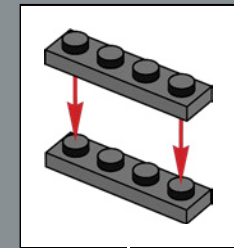

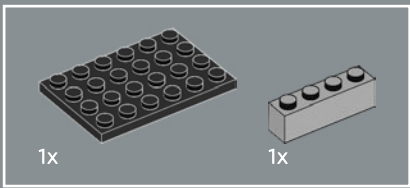

63

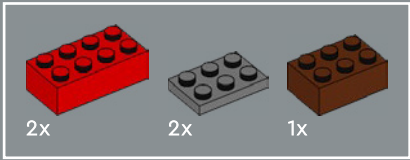
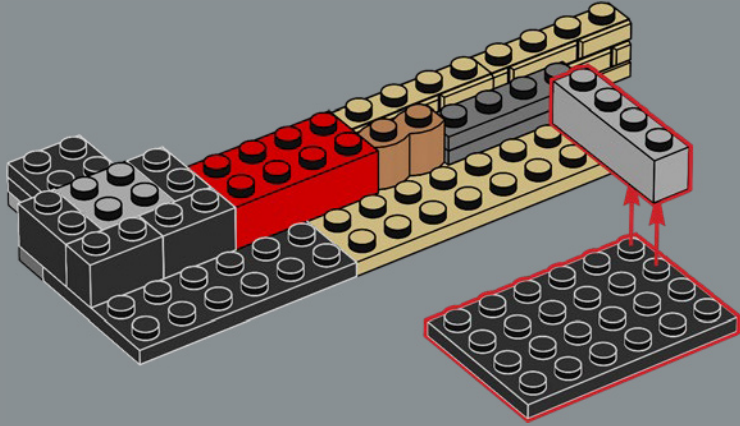

64

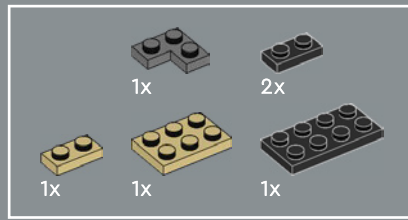
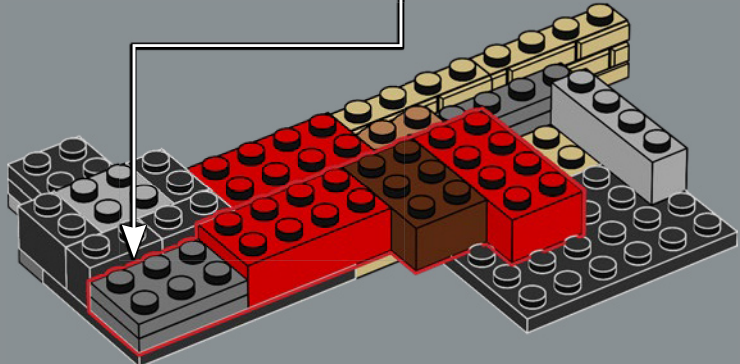
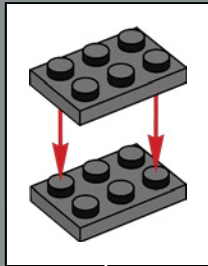

65

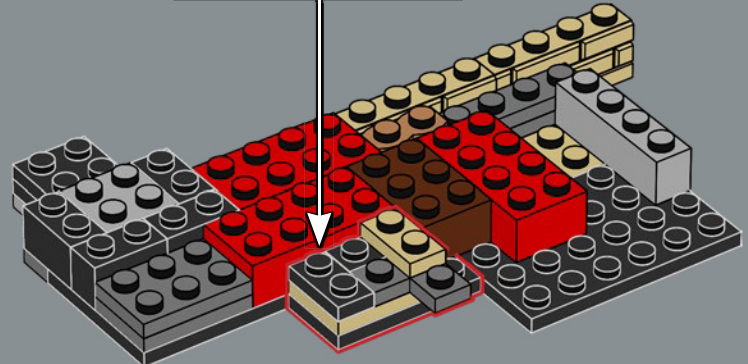
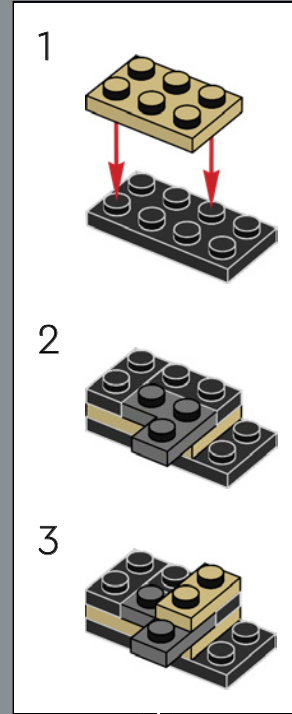



66

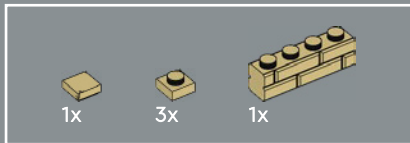
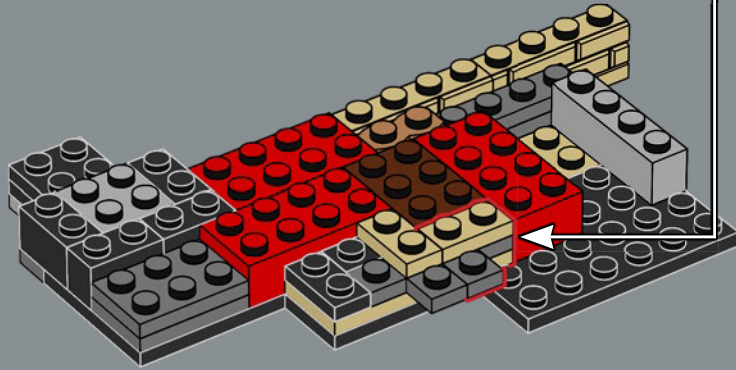
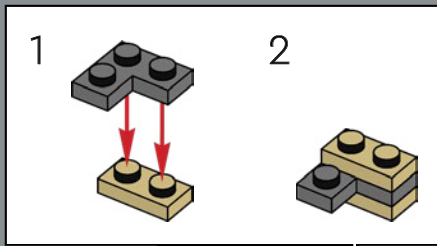

67

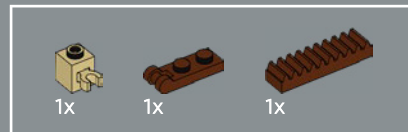
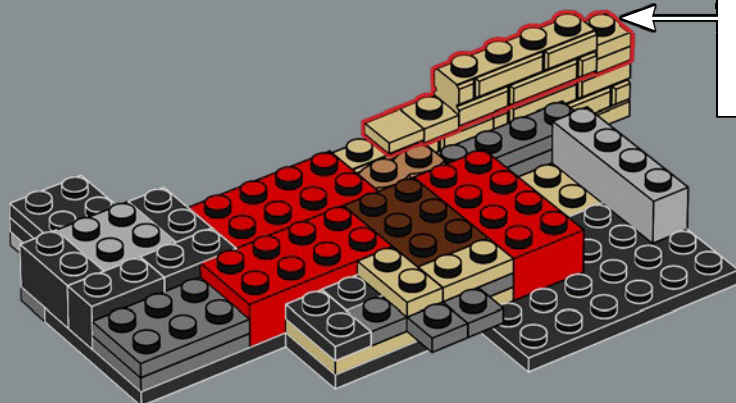
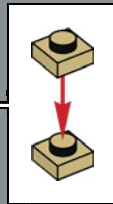

68

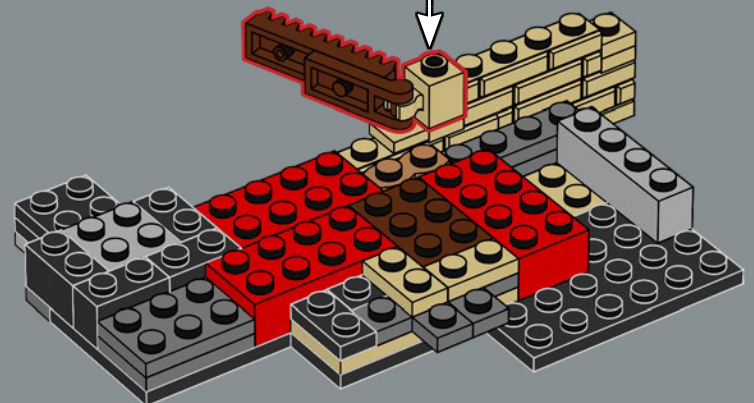
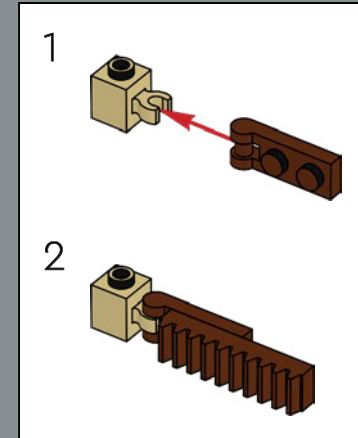

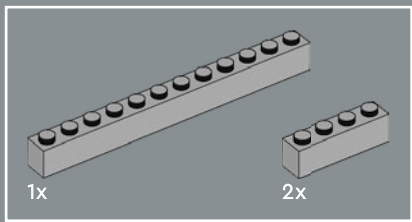

69

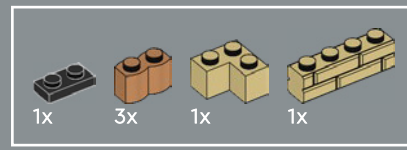
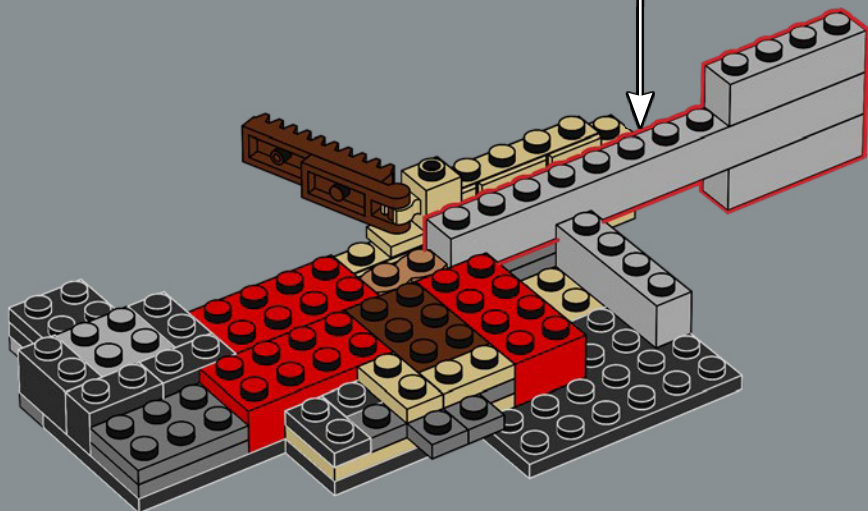
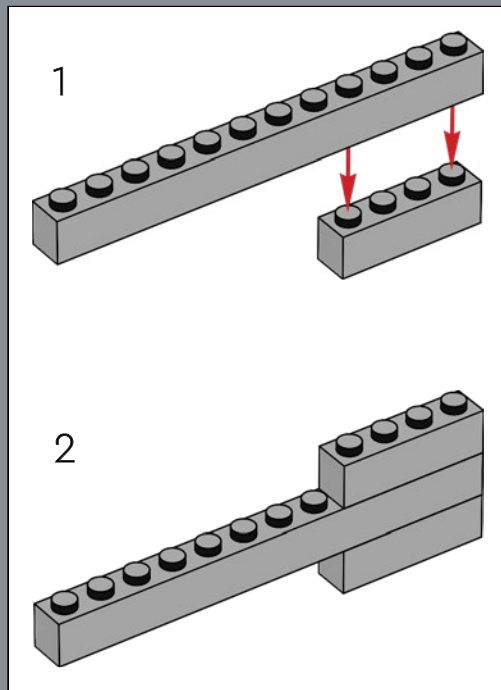

70

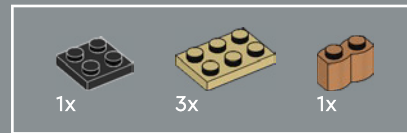
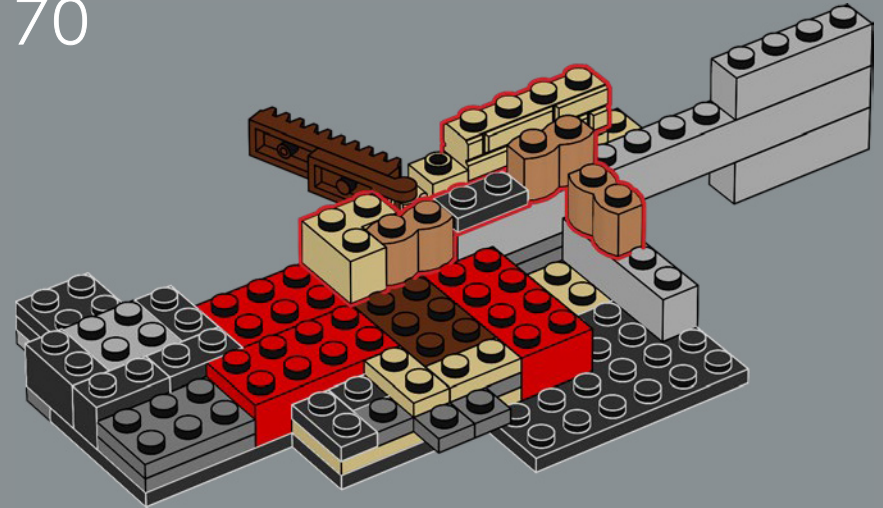

71

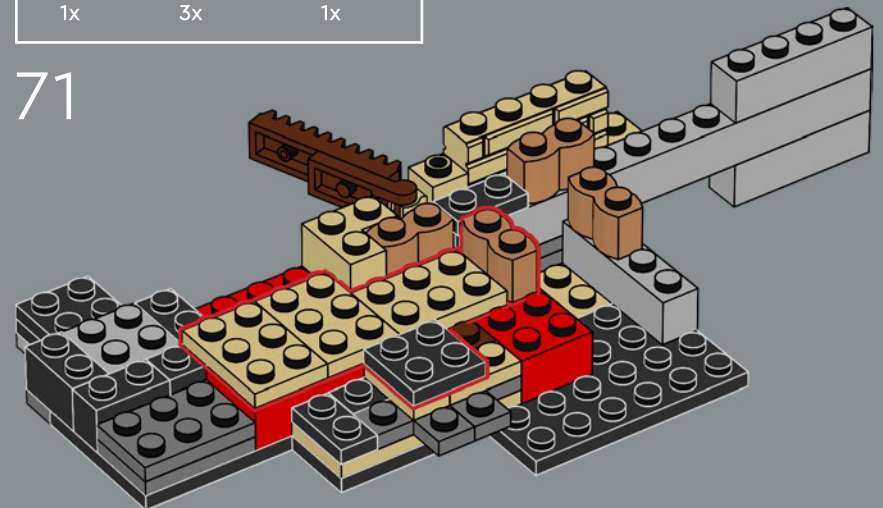

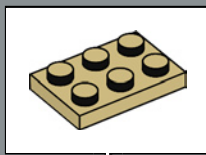
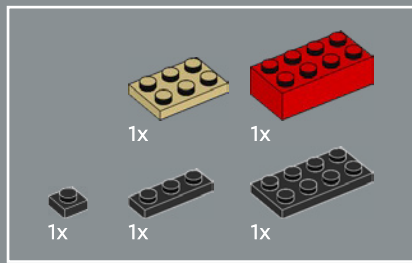

72

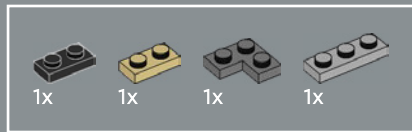
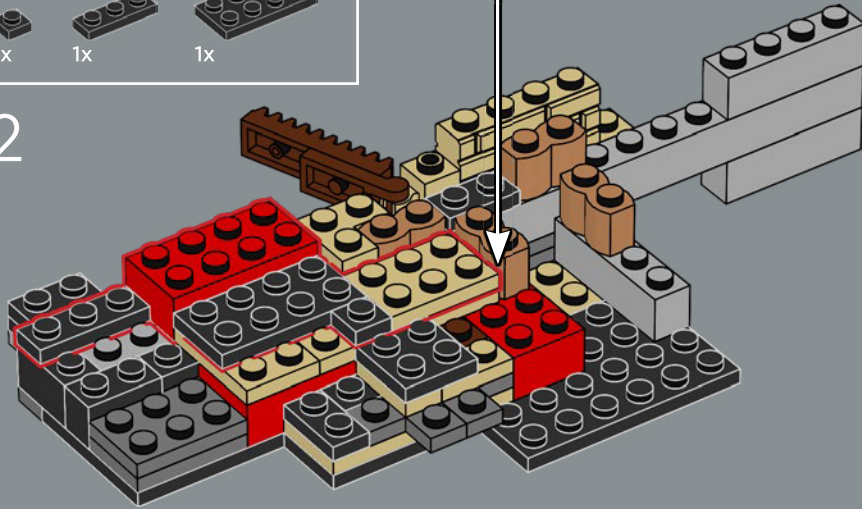

73

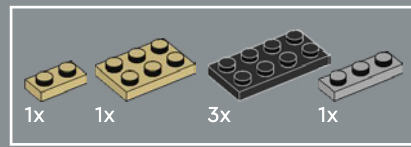
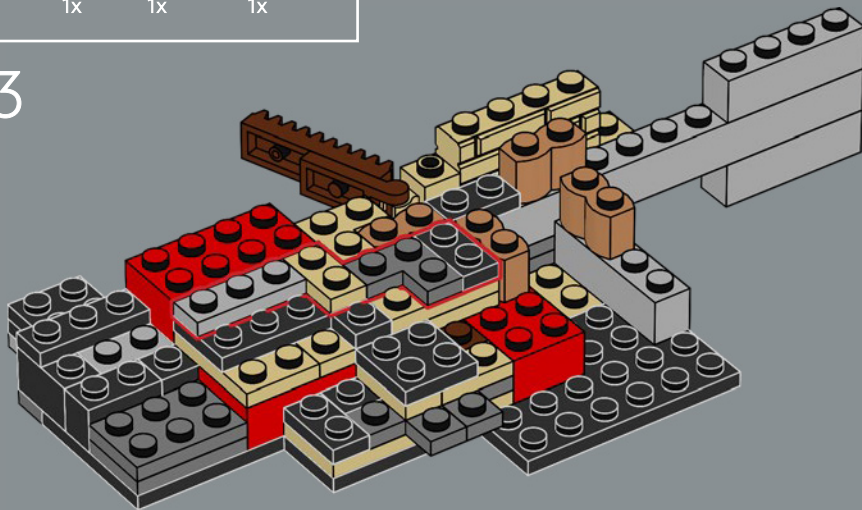

74

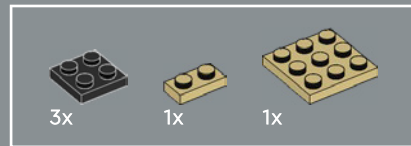
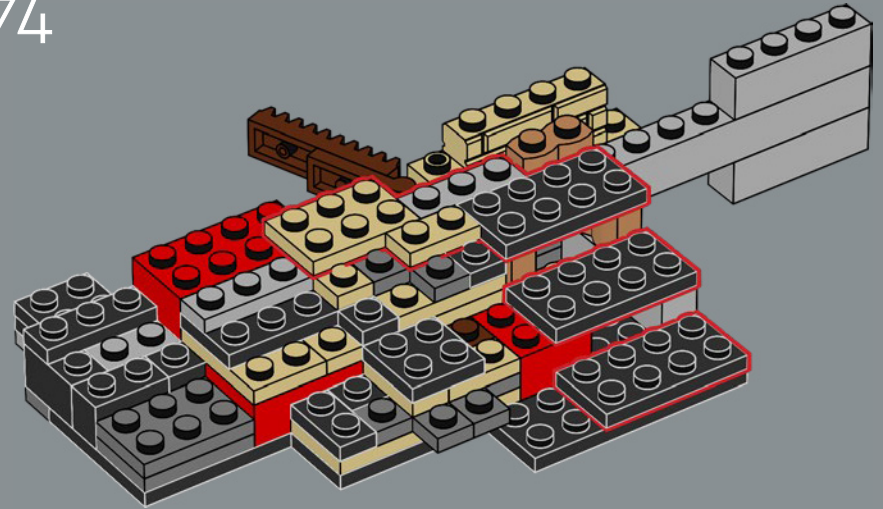

75

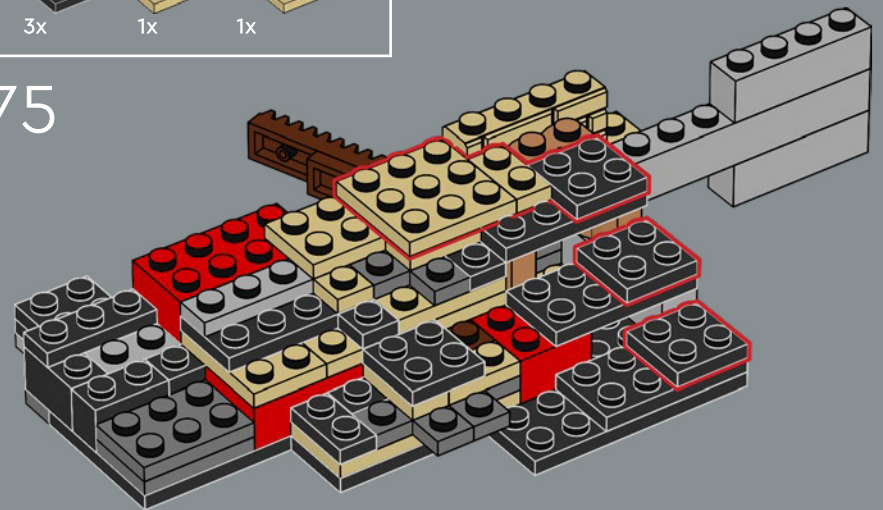

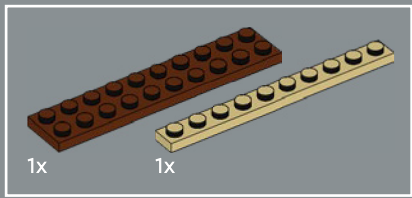

76

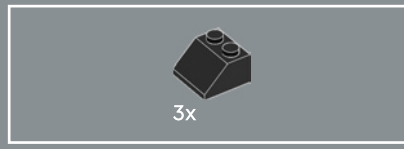
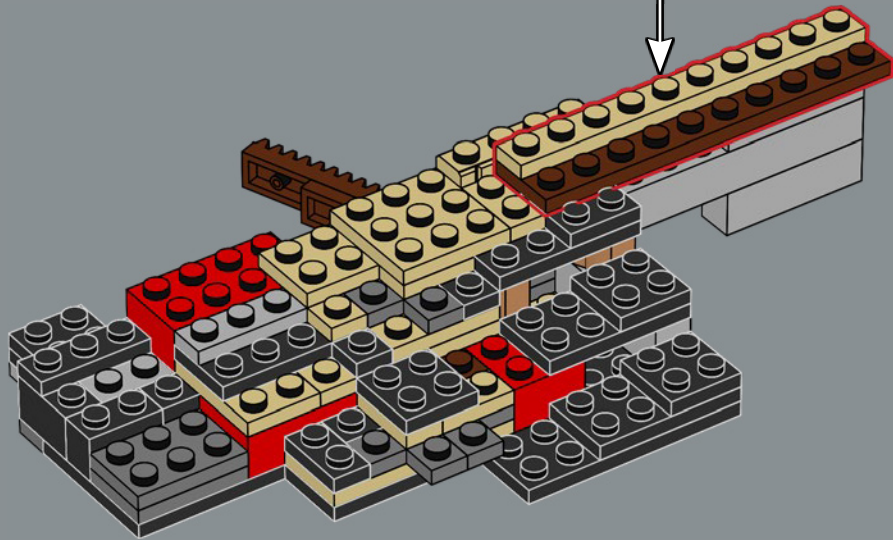
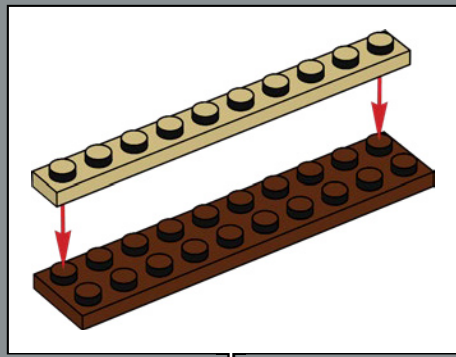

77

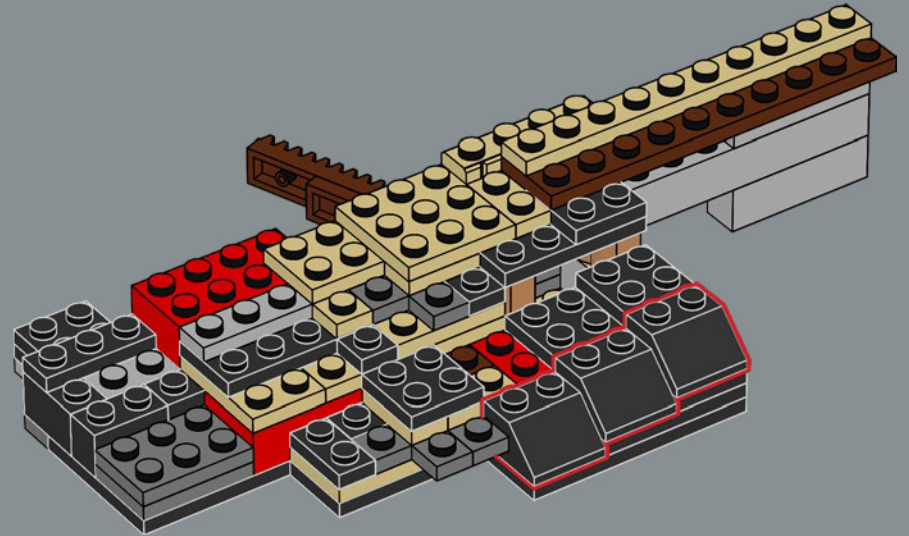



78

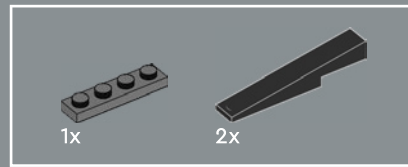
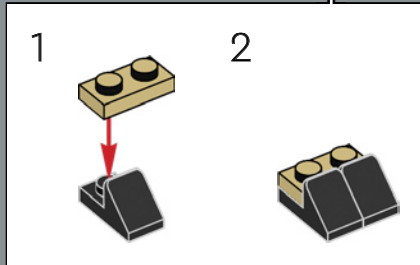
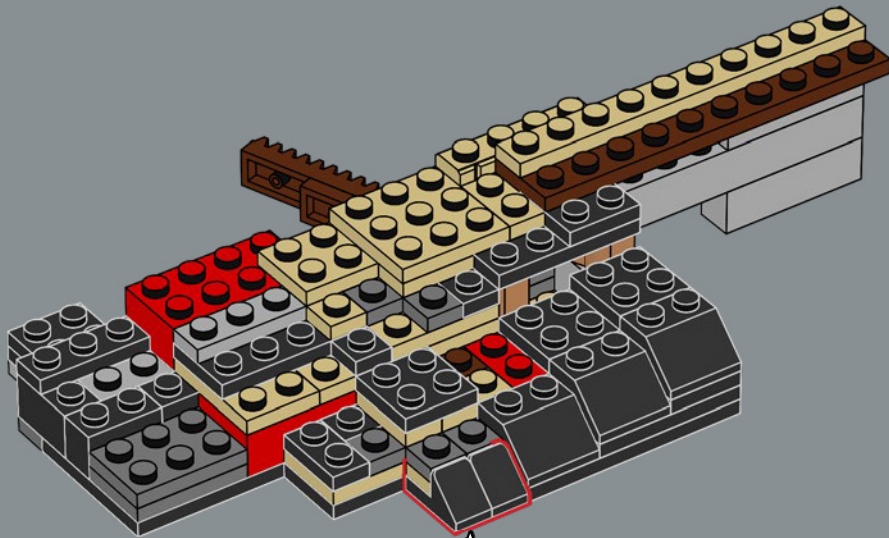

79

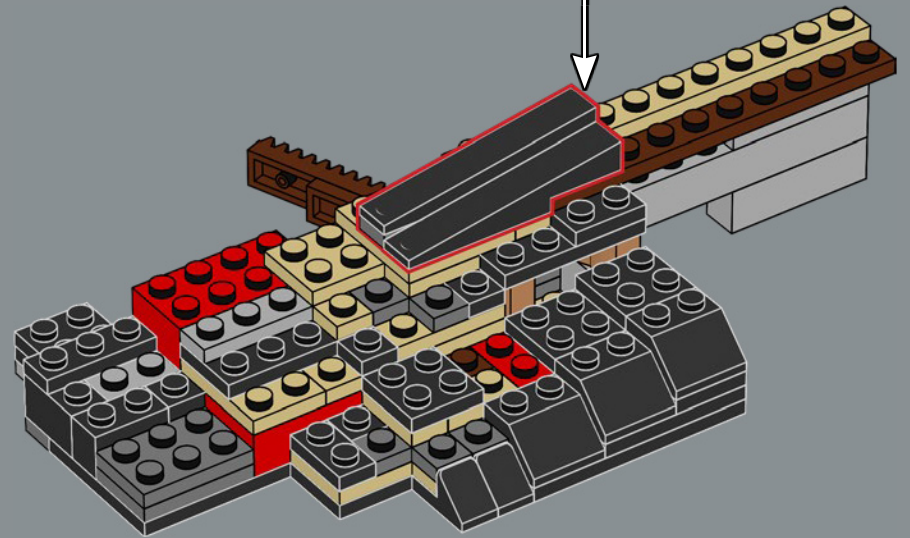
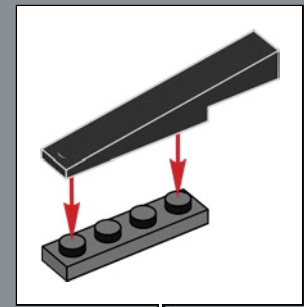



80

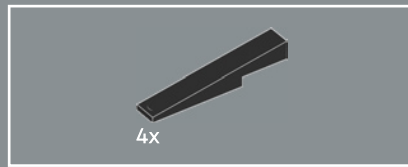
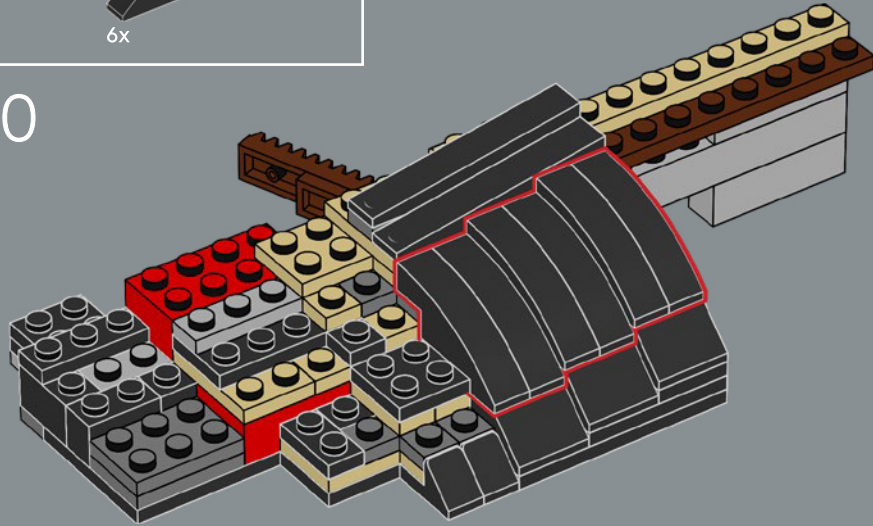

82

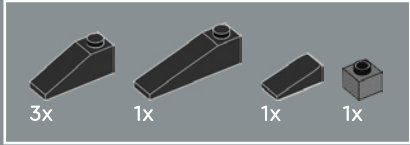
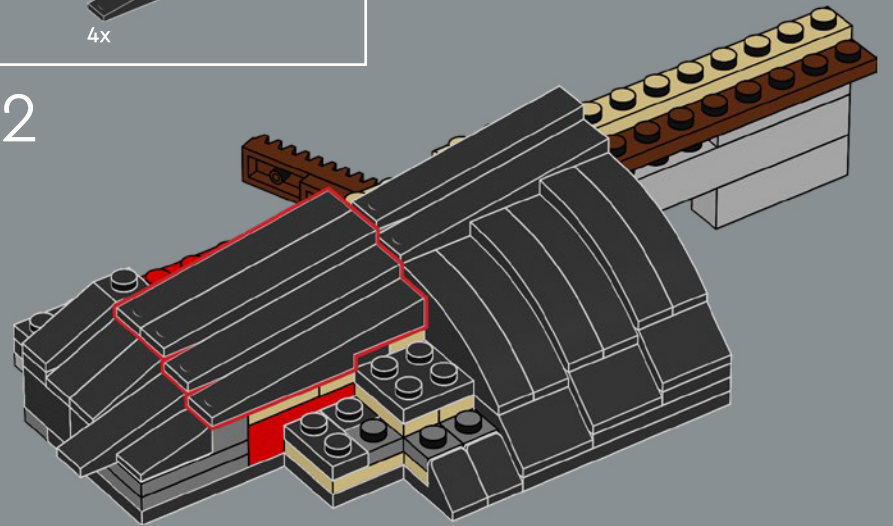

81

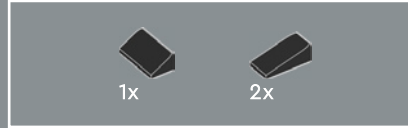
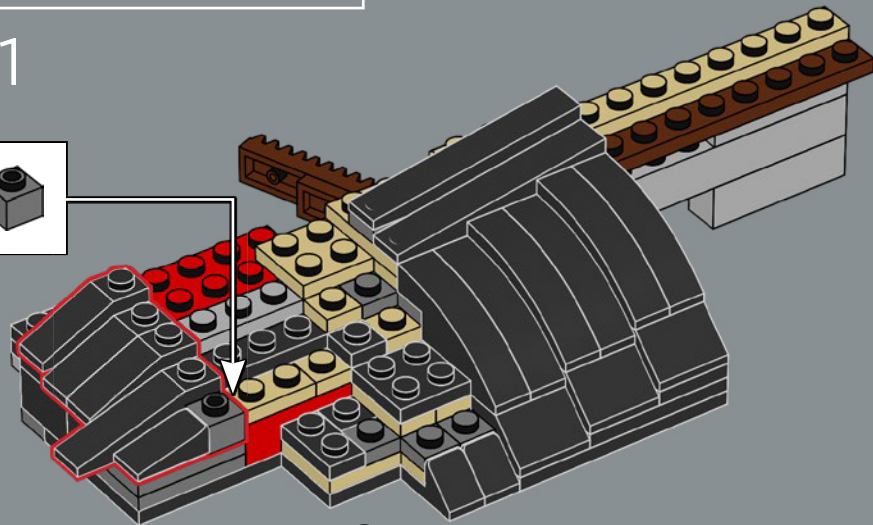
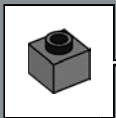

83

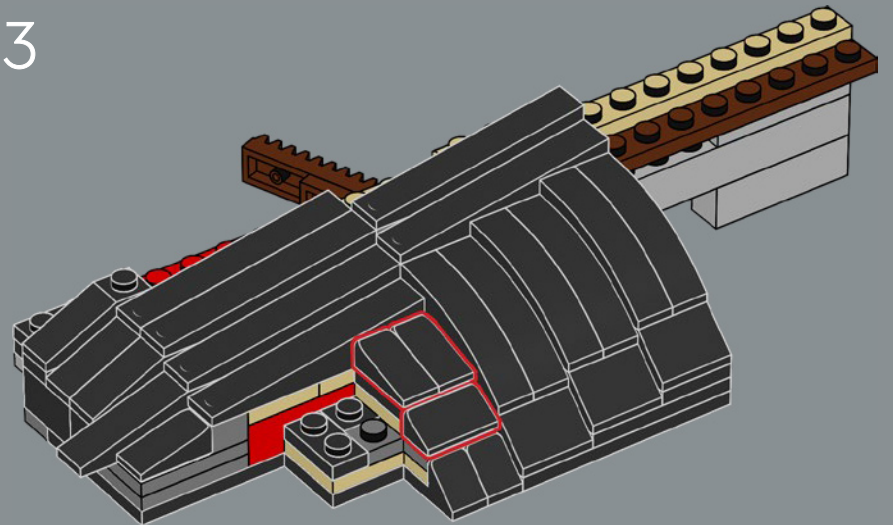

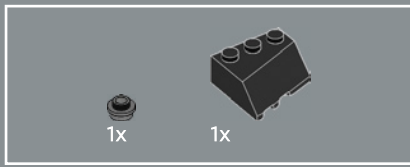

84

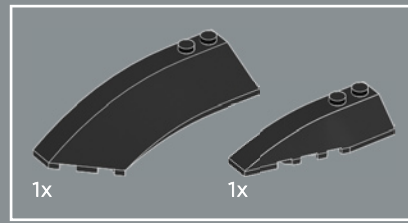
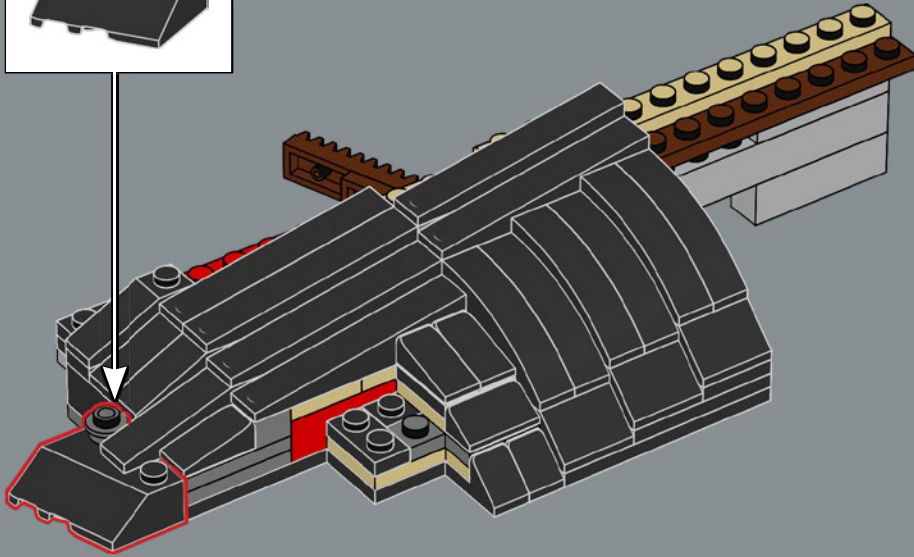
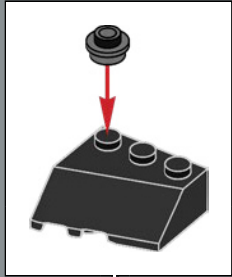

85

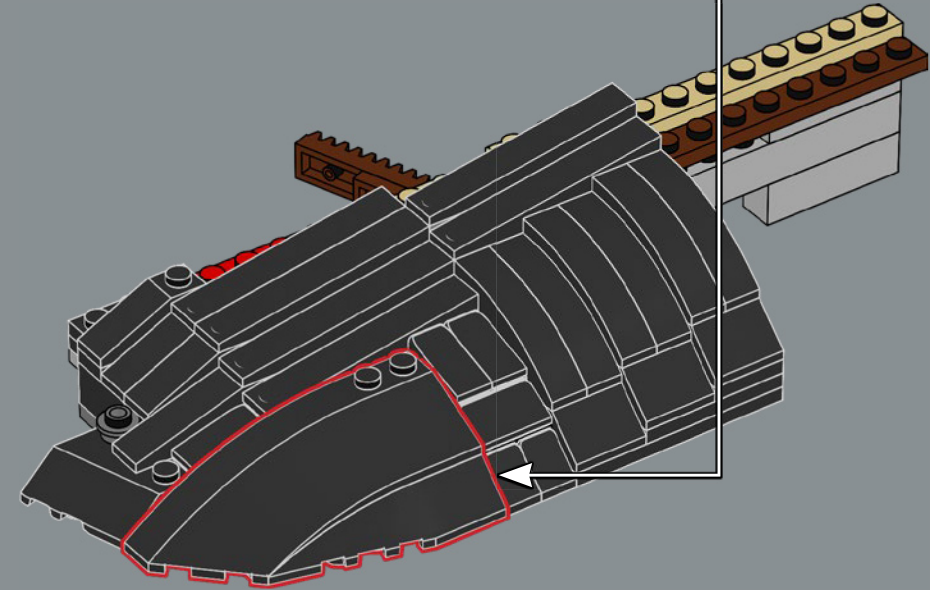
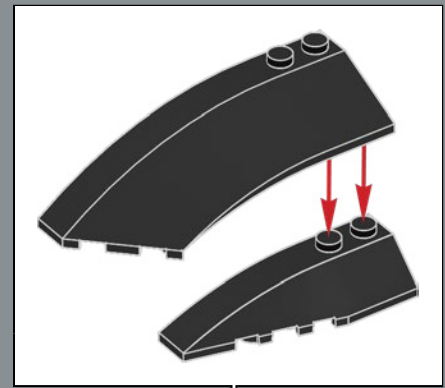



Los elementos LEGO® Technic de barras dentadas marrones 1x4 recrean a la perfección las escaleras de madera.

86

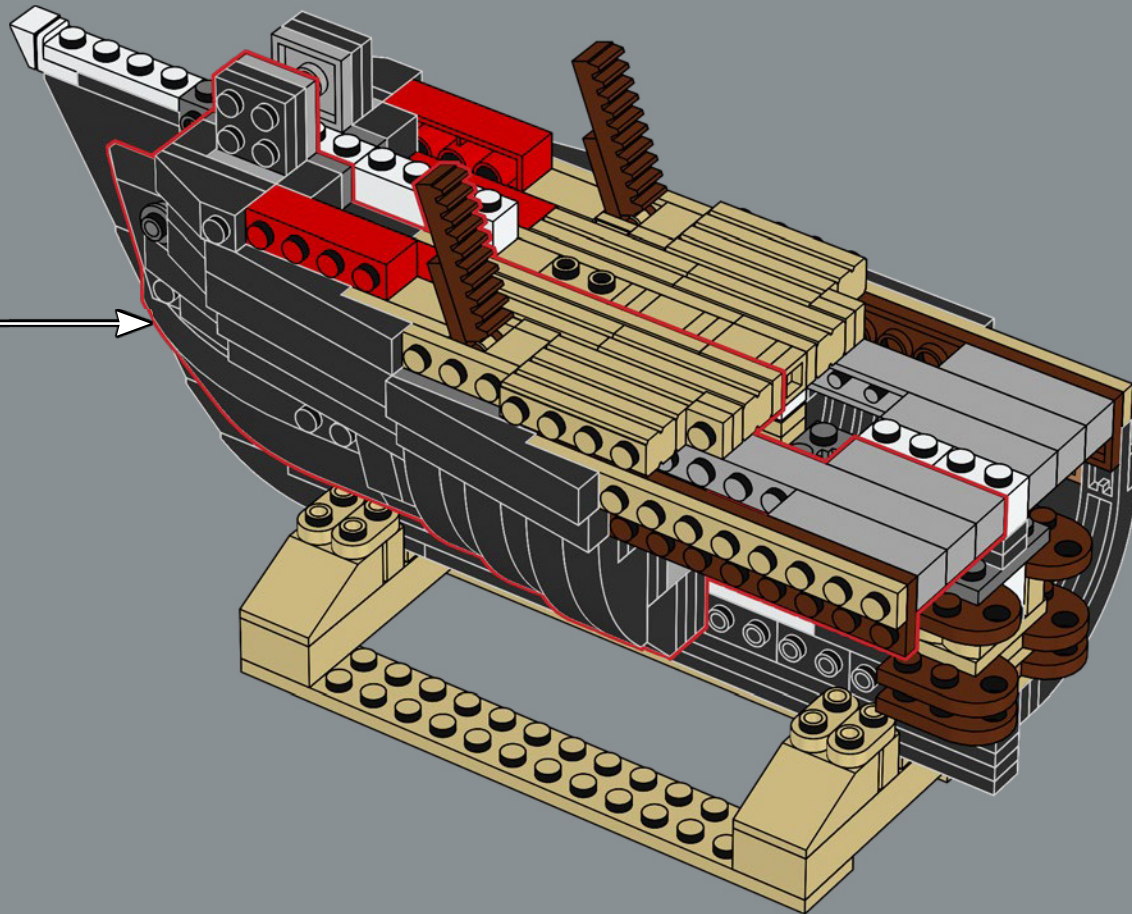

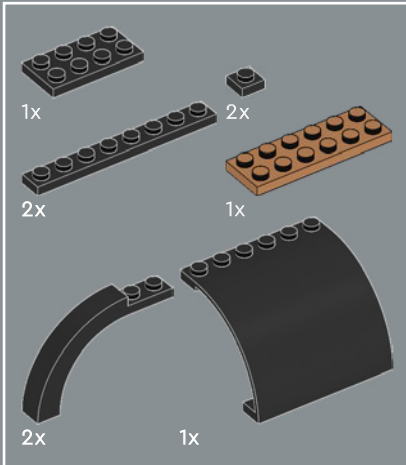
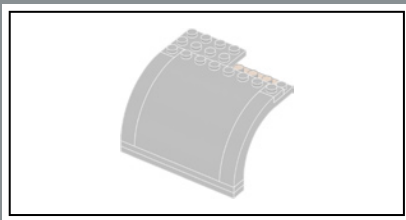

87

1

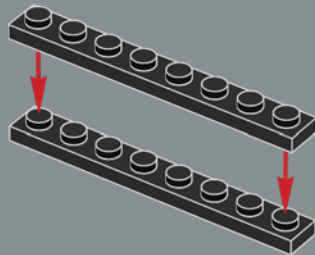

2

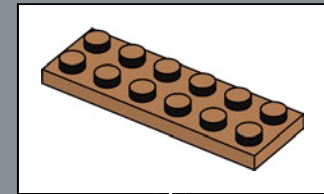
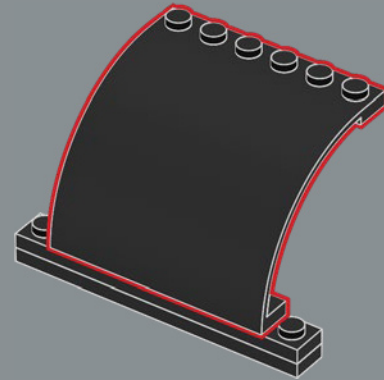

3

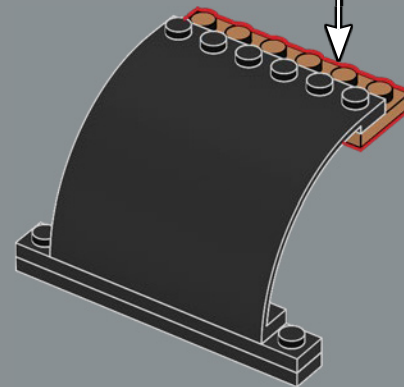

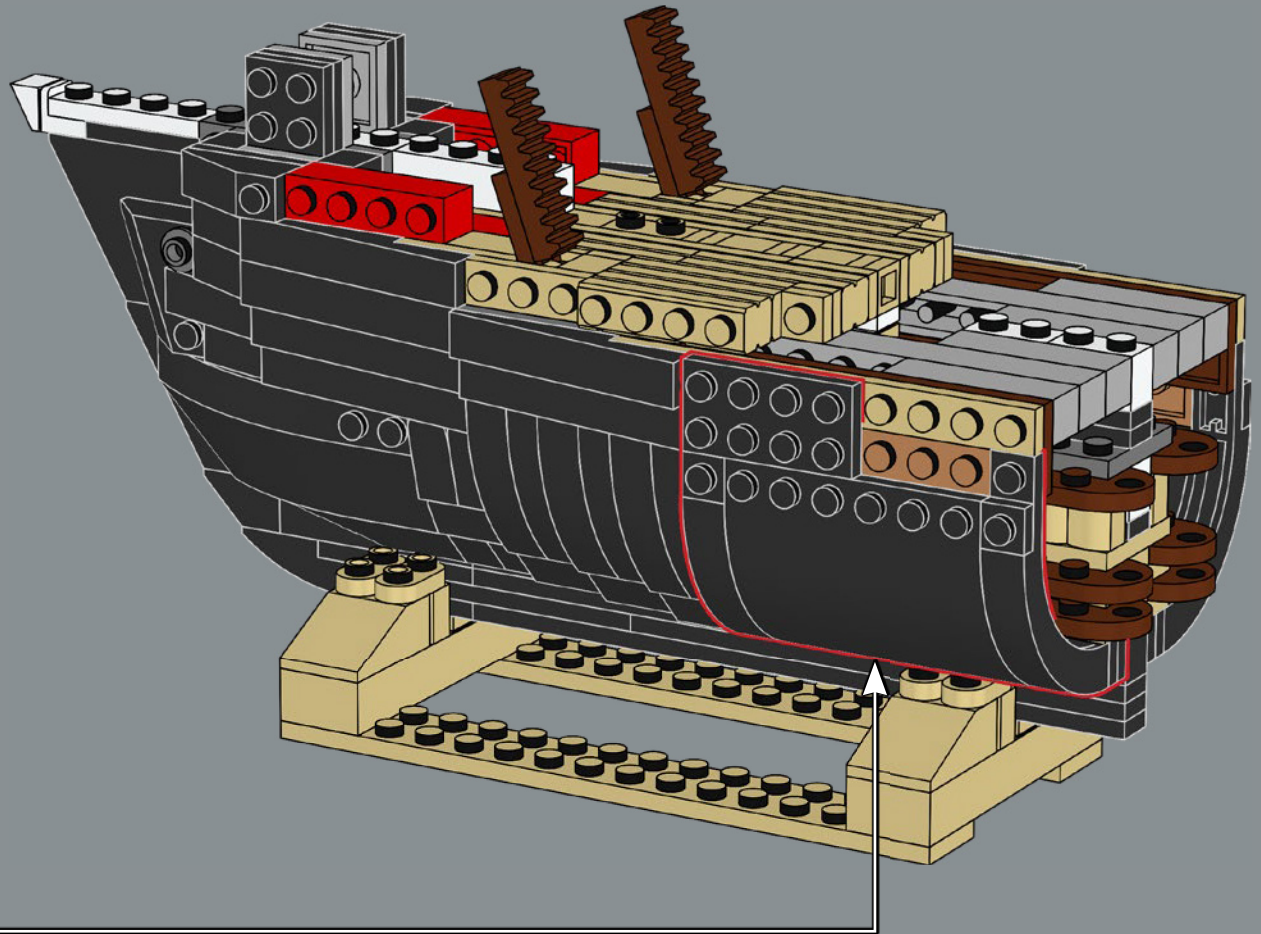
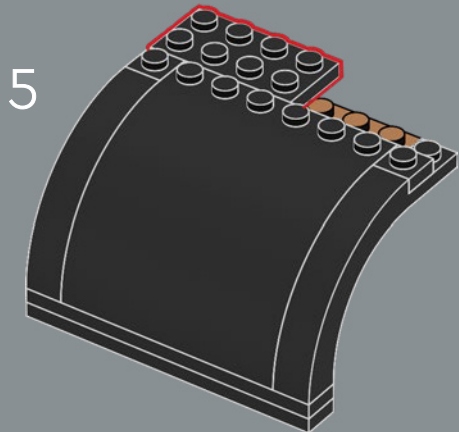
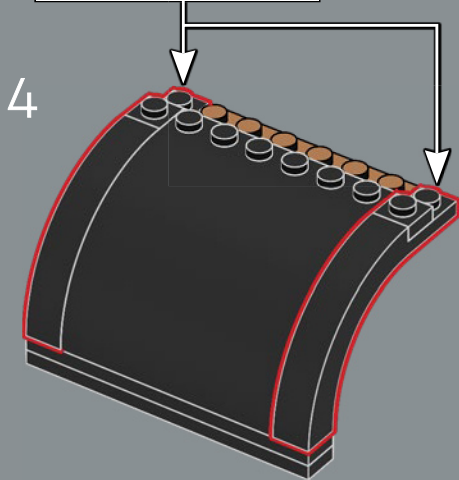
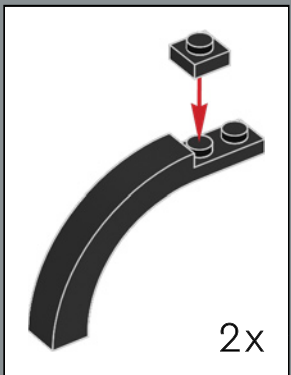

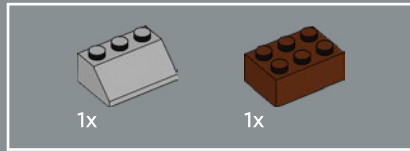

88

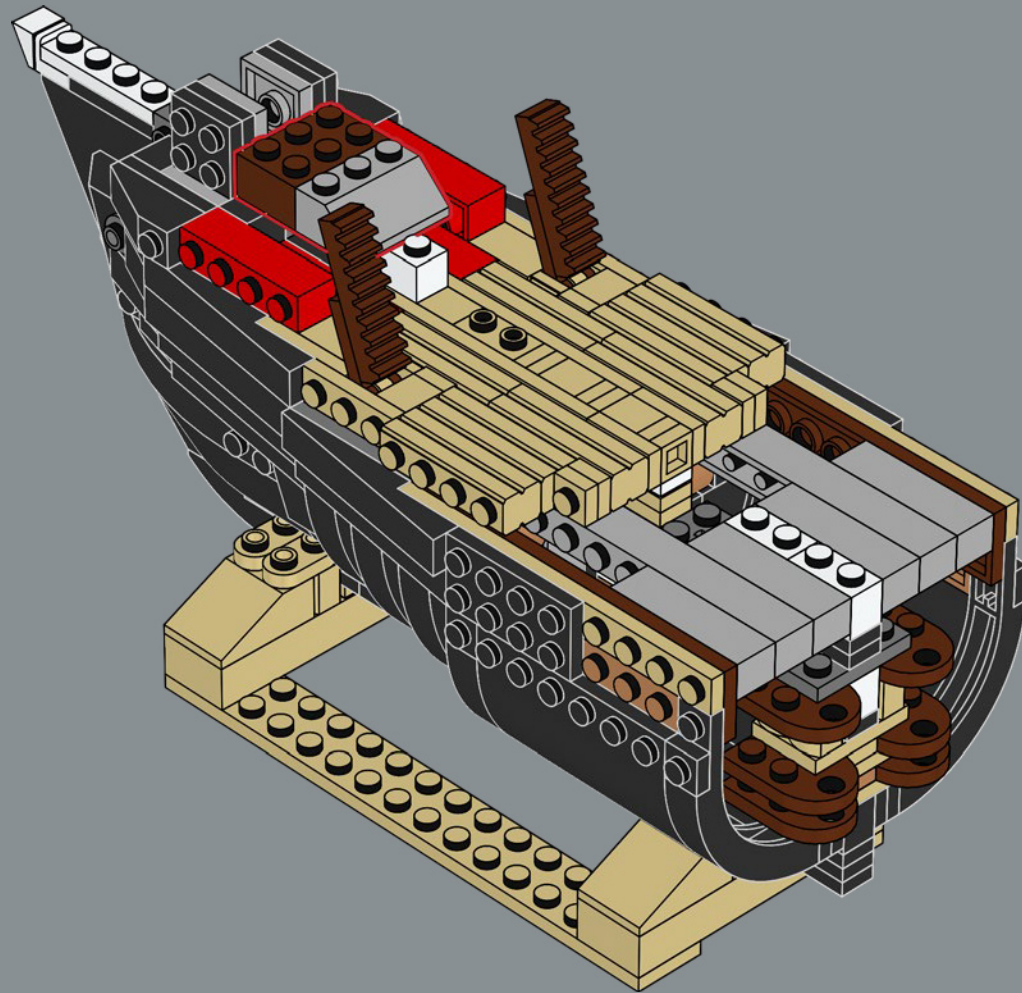



2x

89

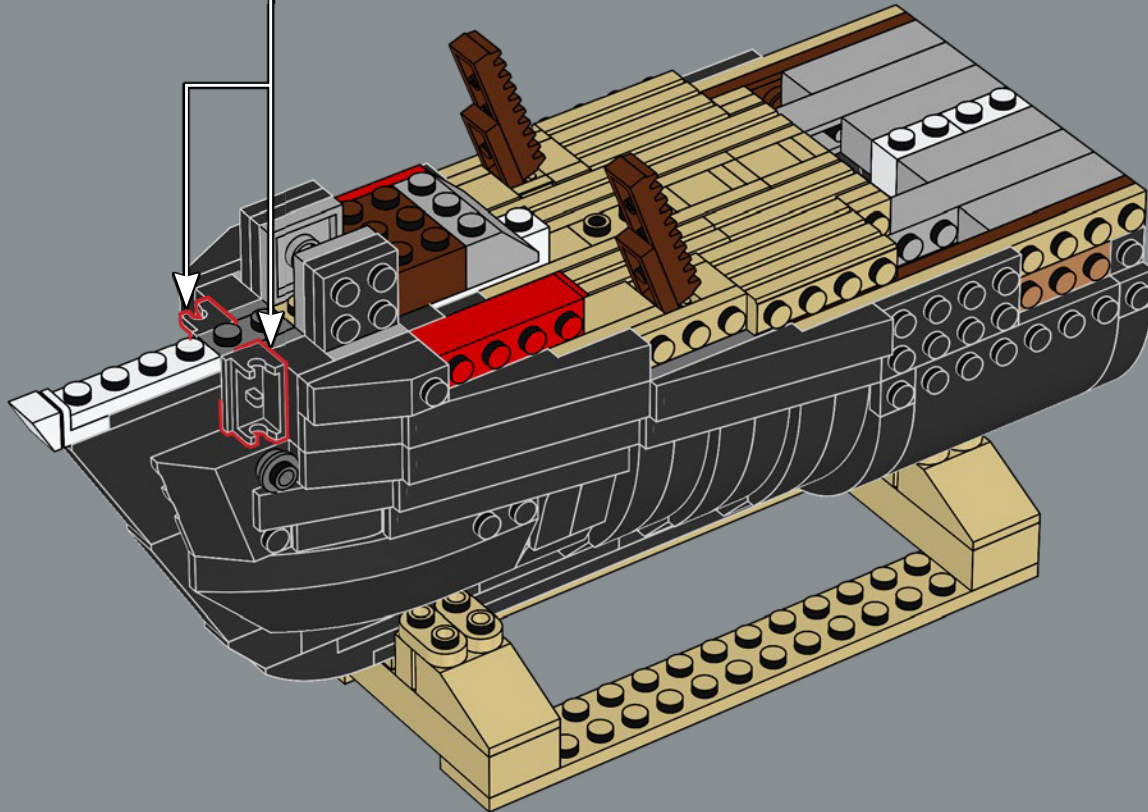
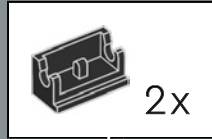

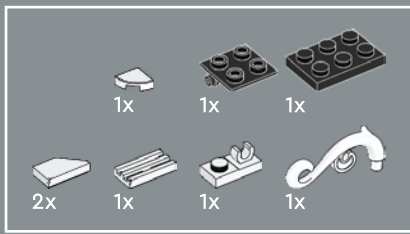

90

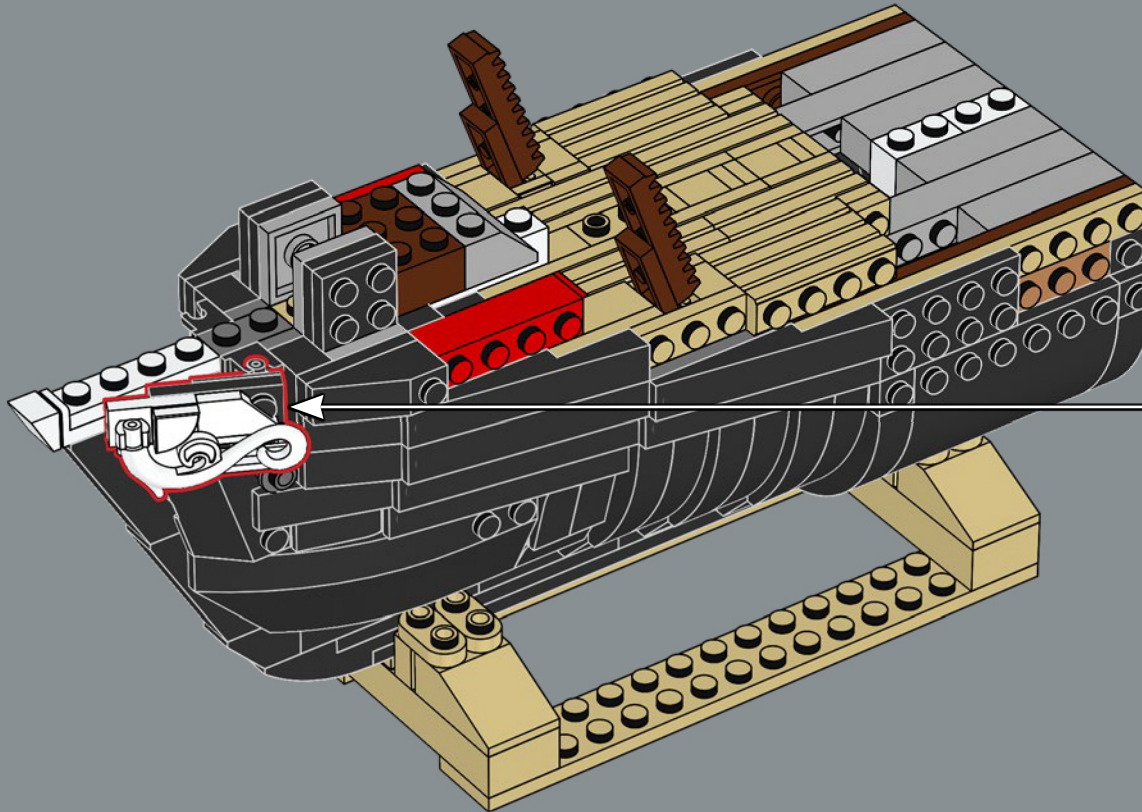
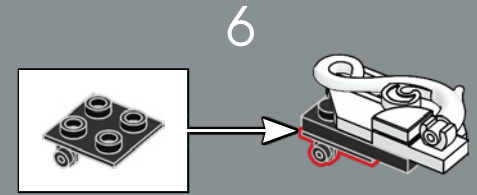
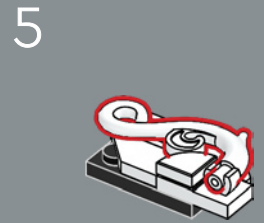
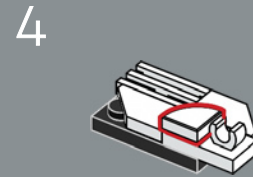
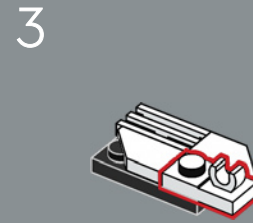
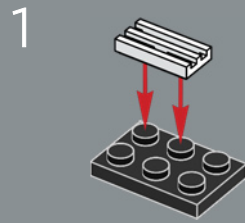

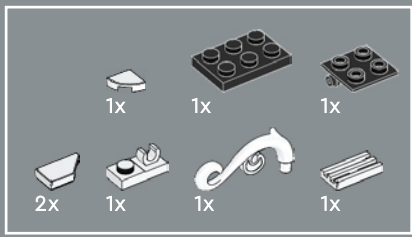

91

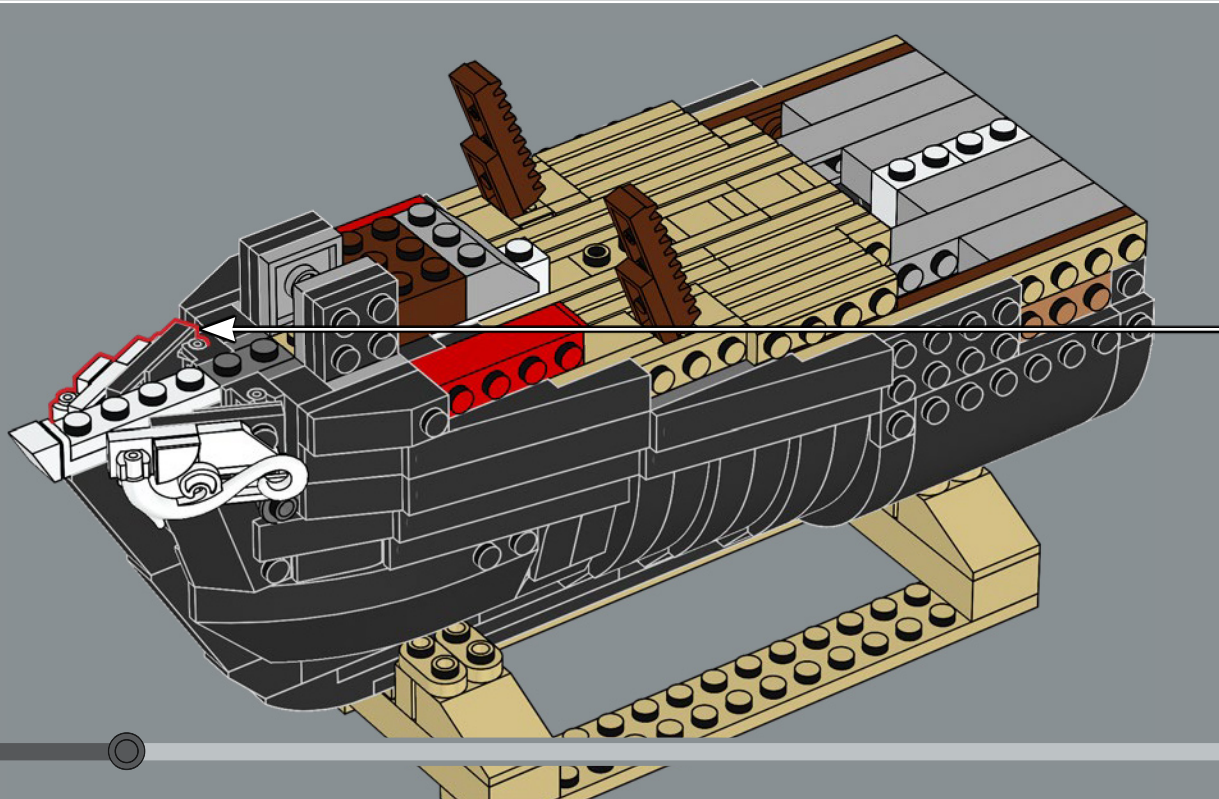
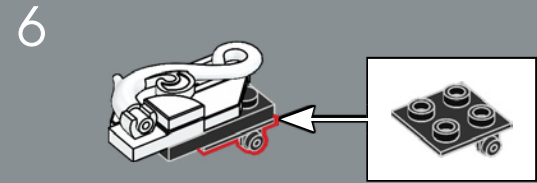
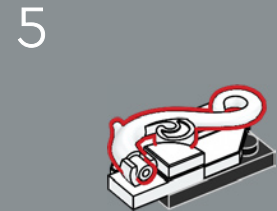
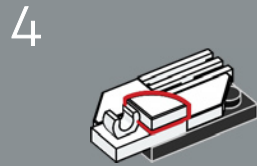
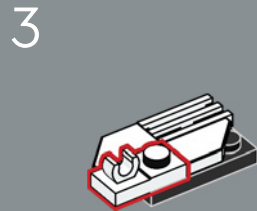
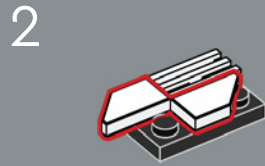
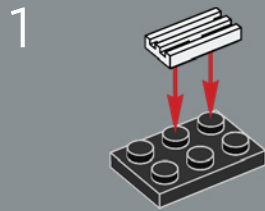

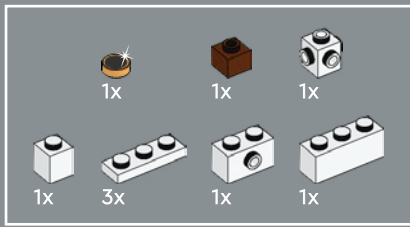

92

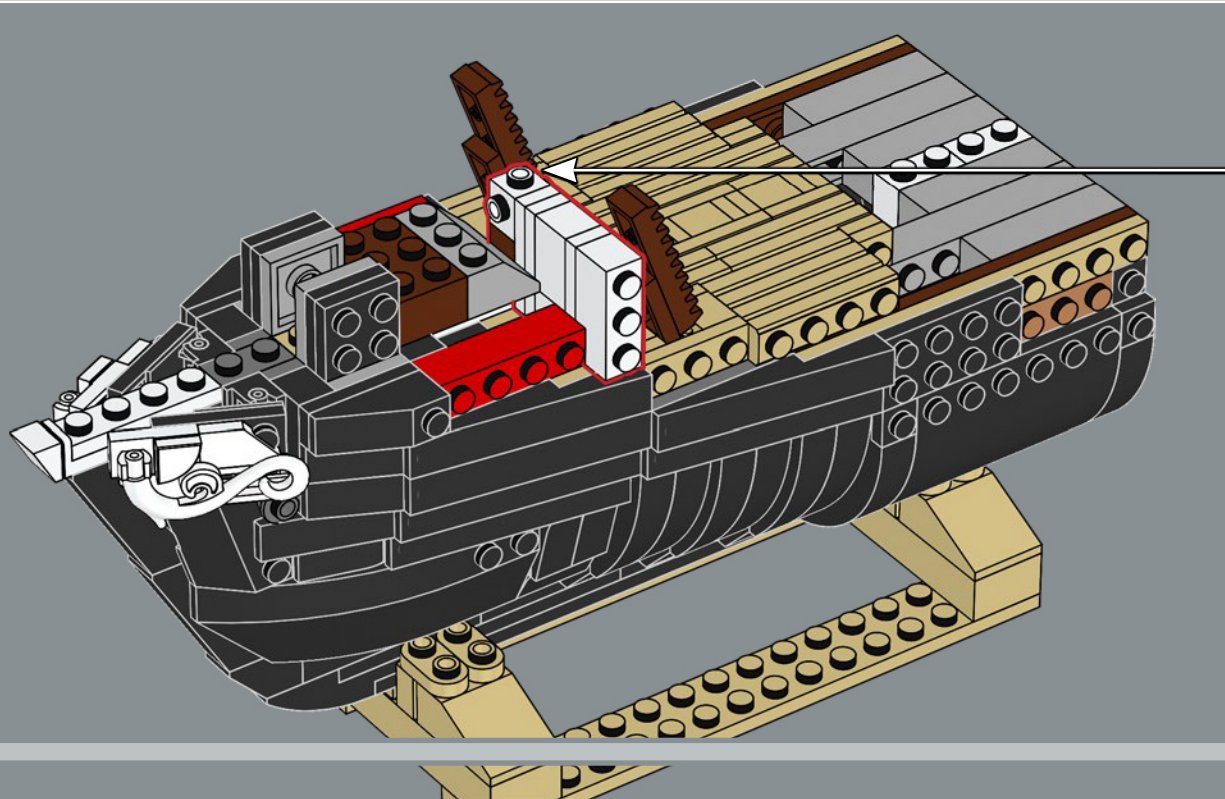
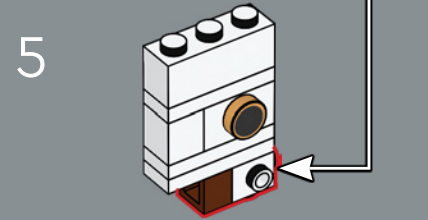
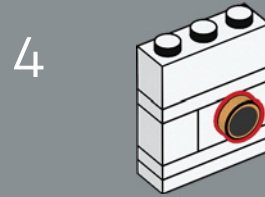
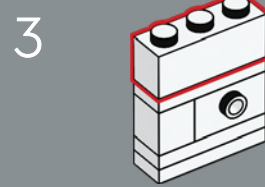
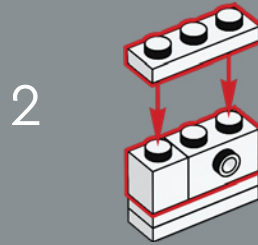
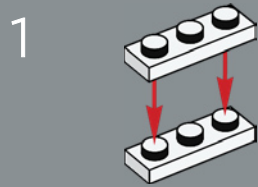

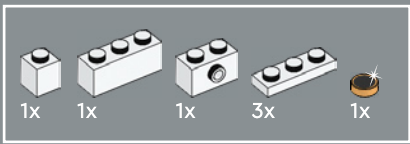

93

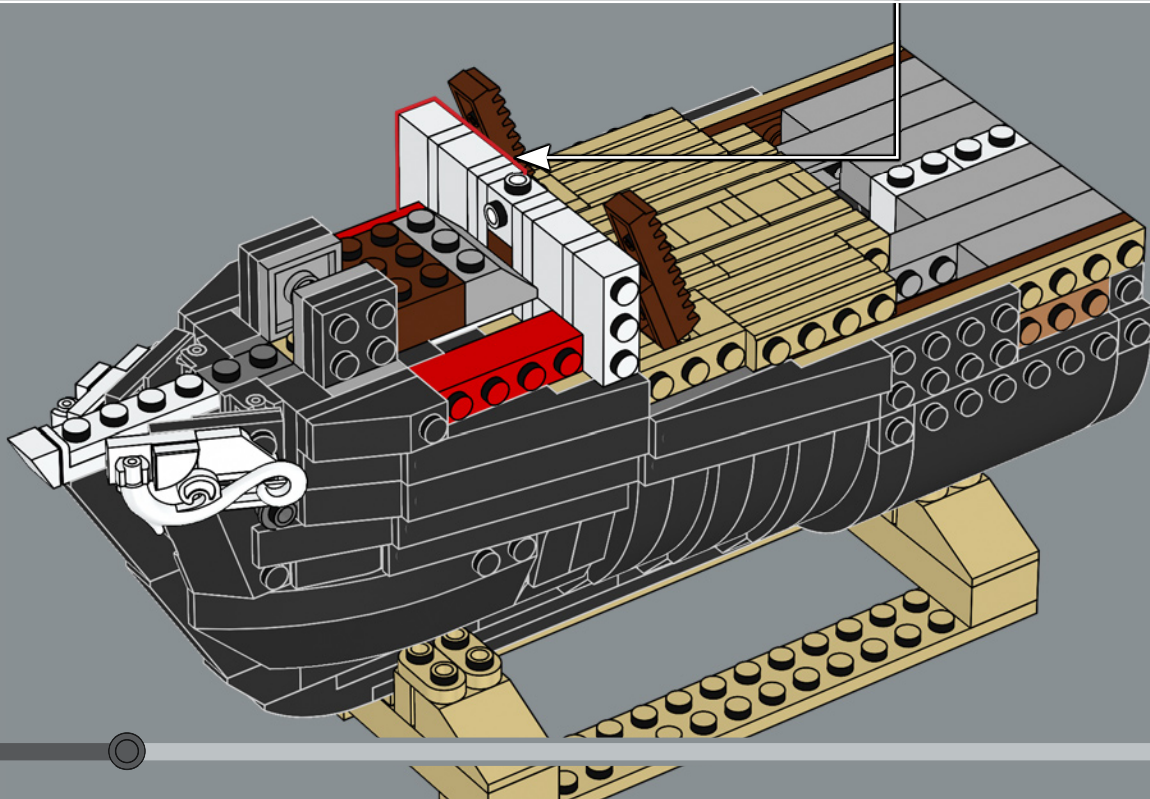
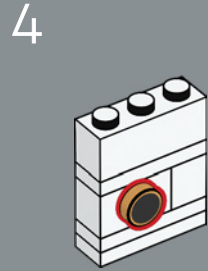
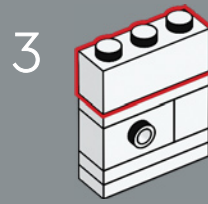
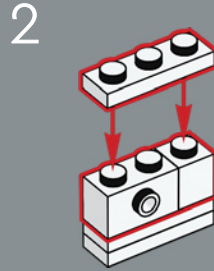
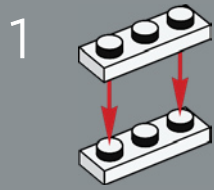

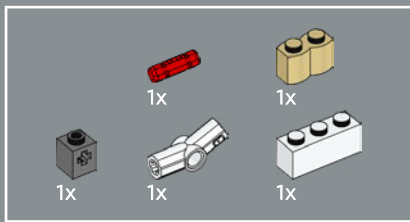

94

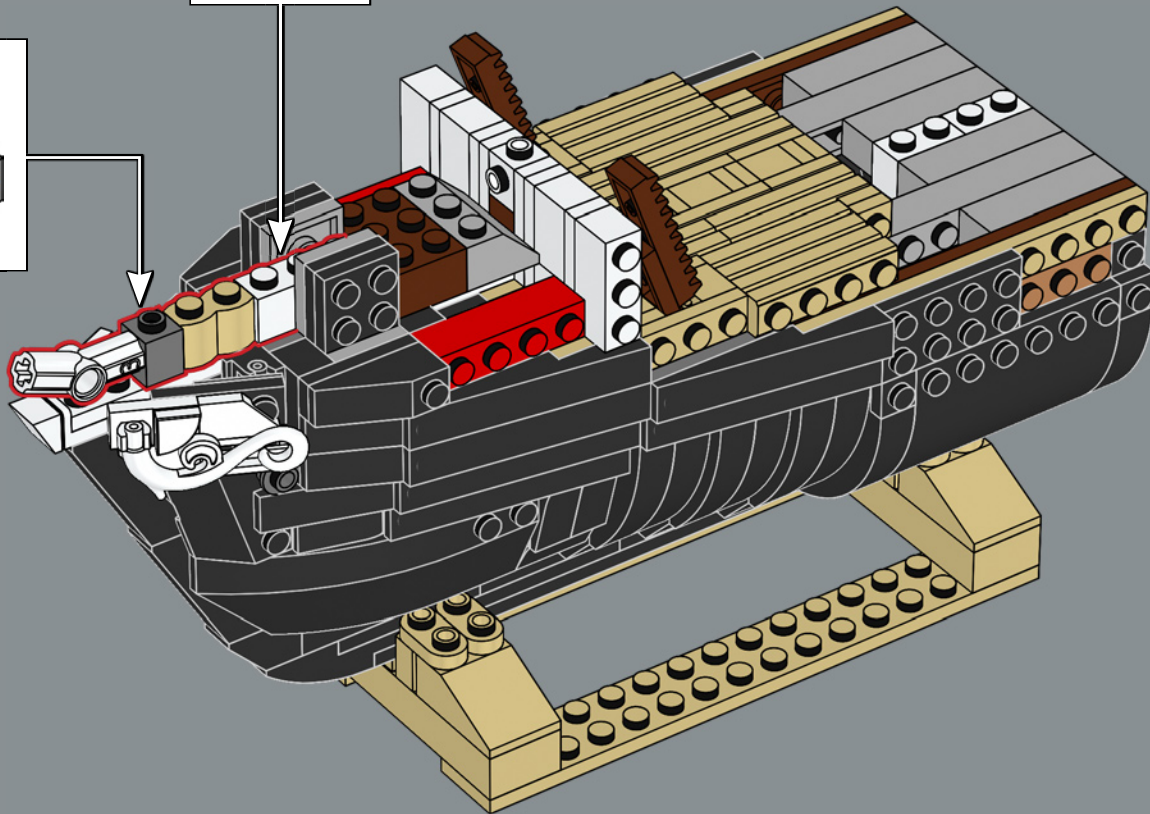
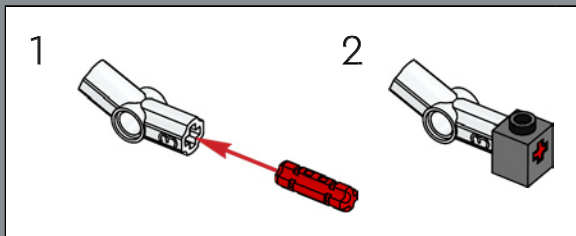
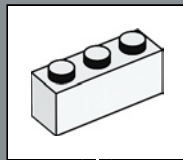

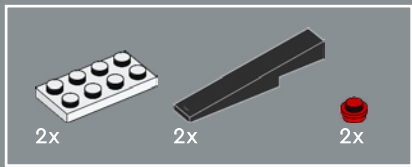

95

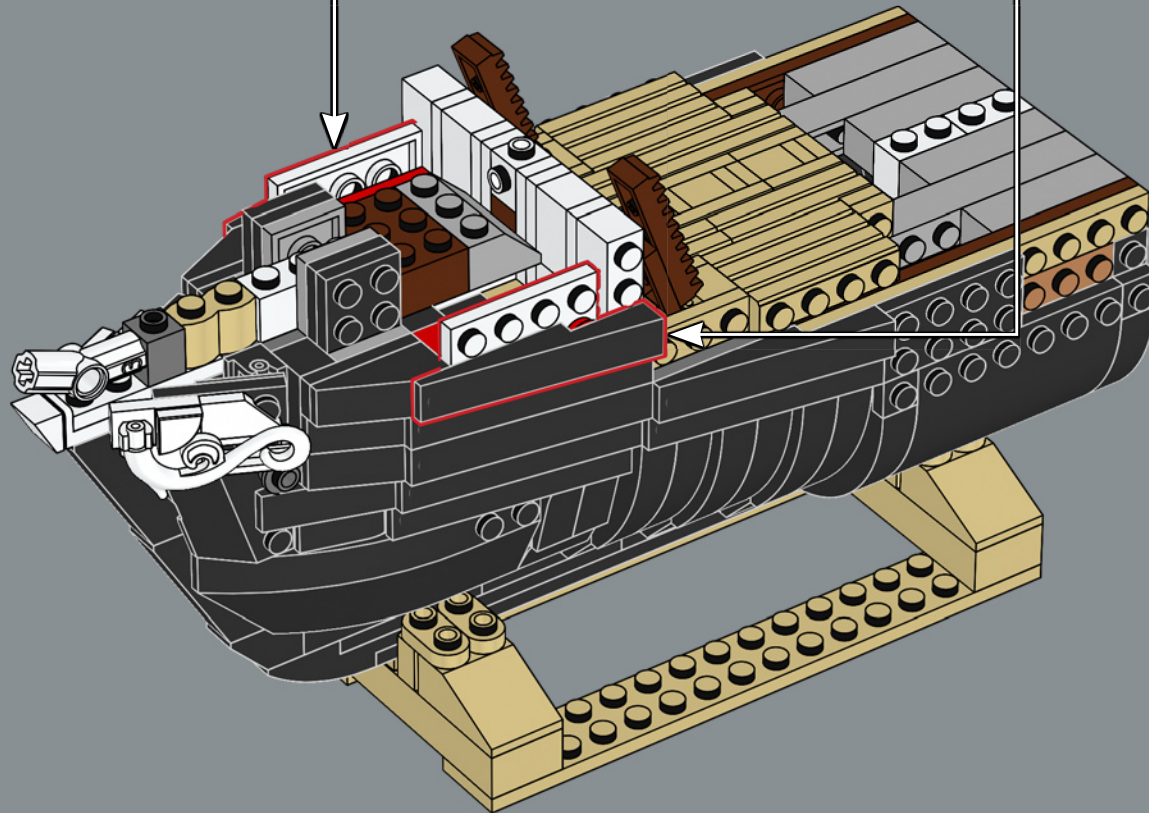
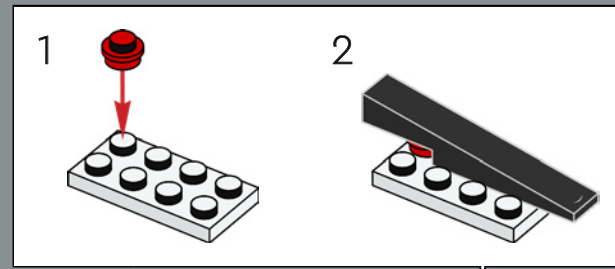
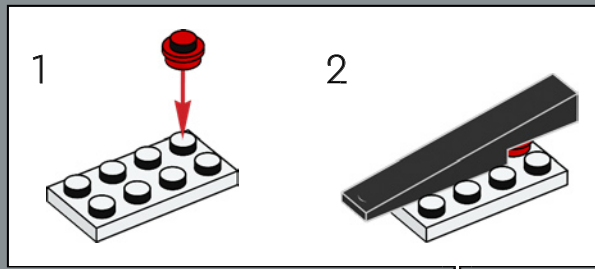

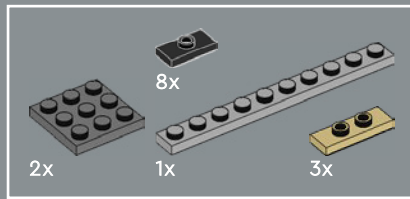

96

1

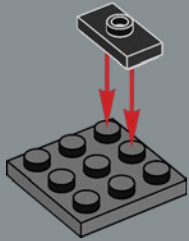

2

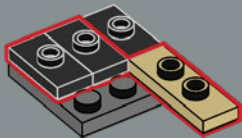

3

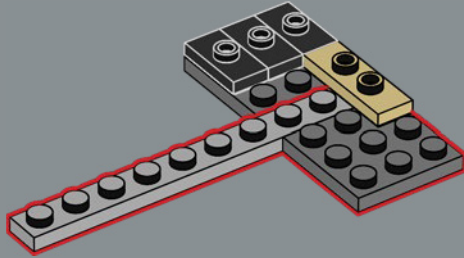

4

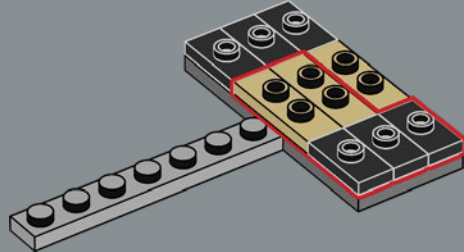

5

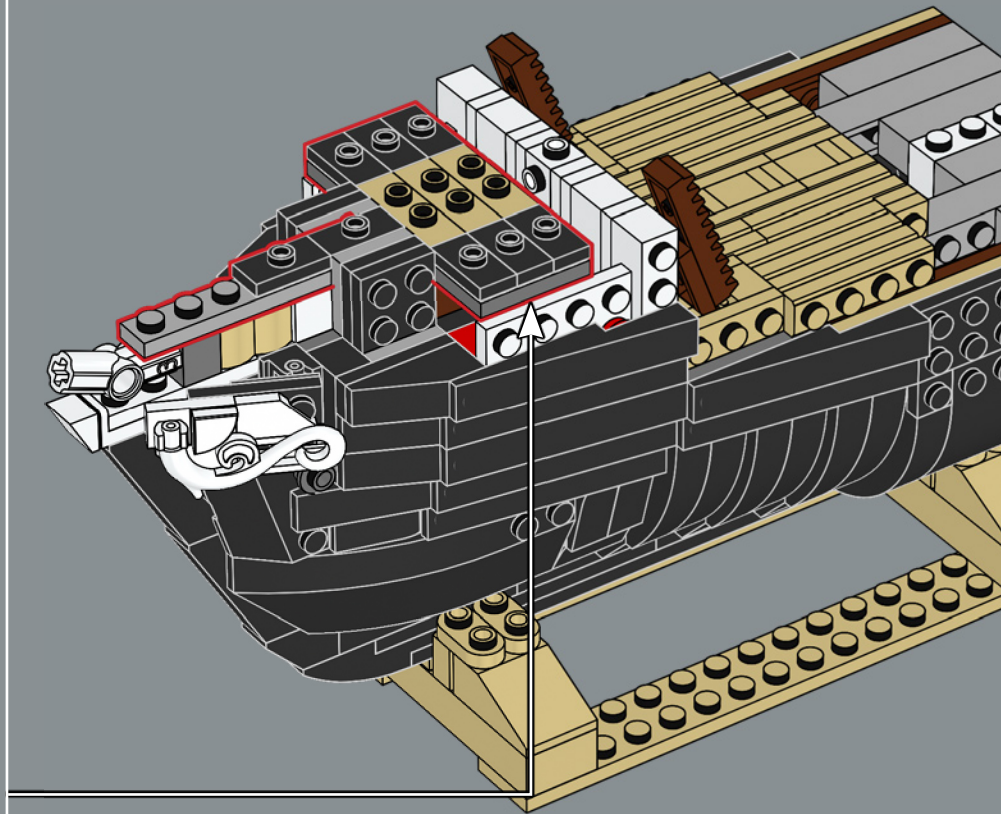
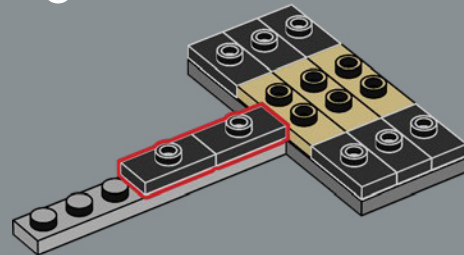

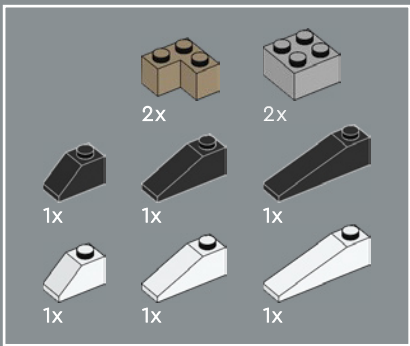

97

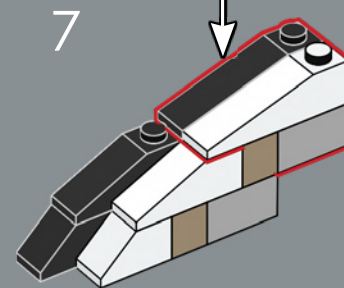
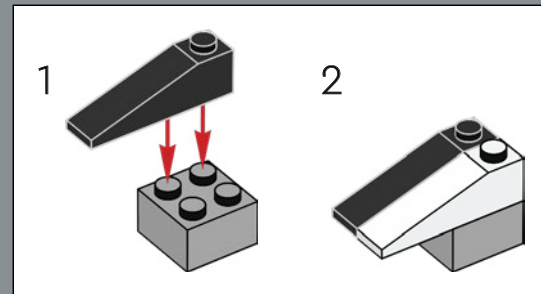
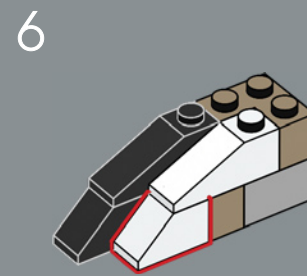
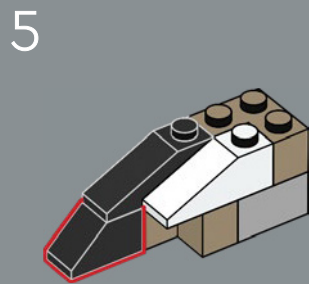
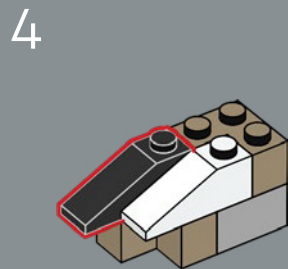
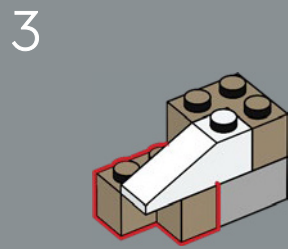
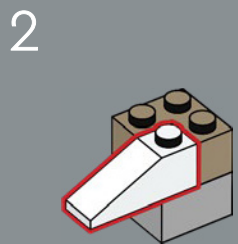
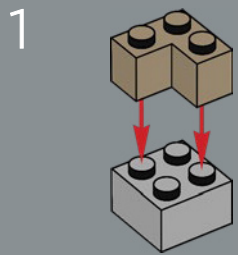

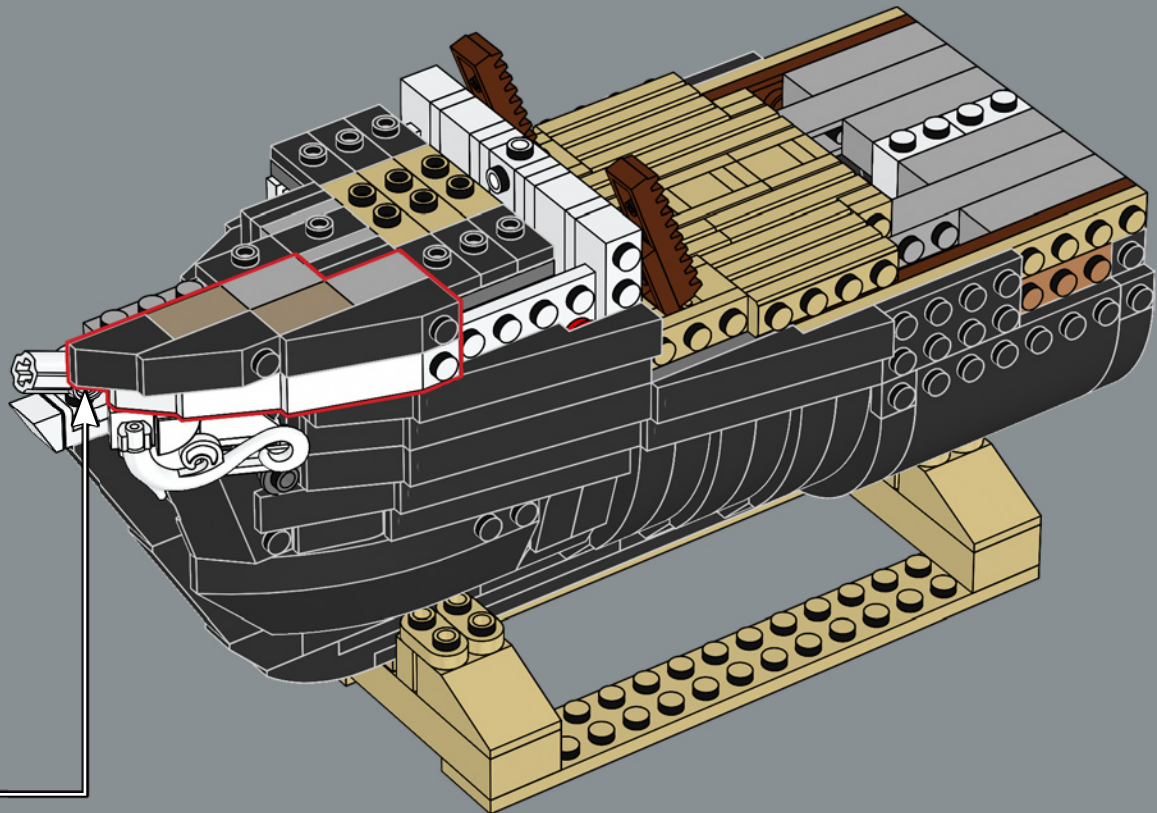

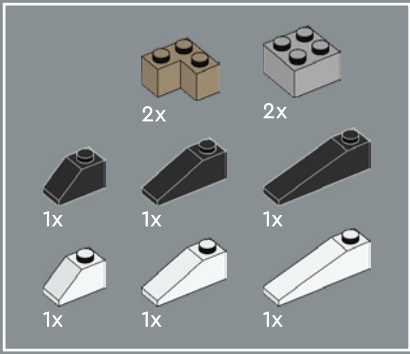

98

1

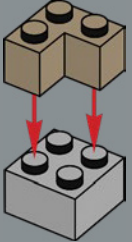

2

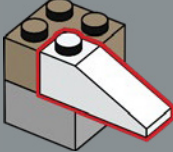

3

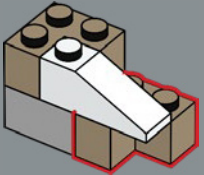

4

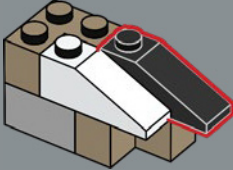

5

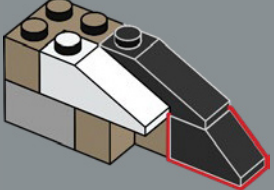

6

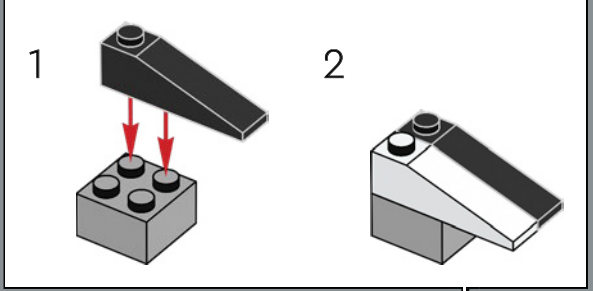
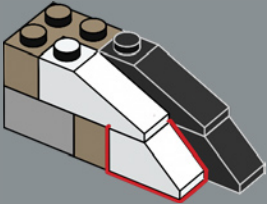

7

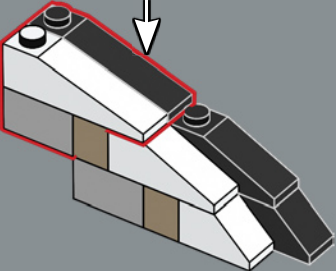

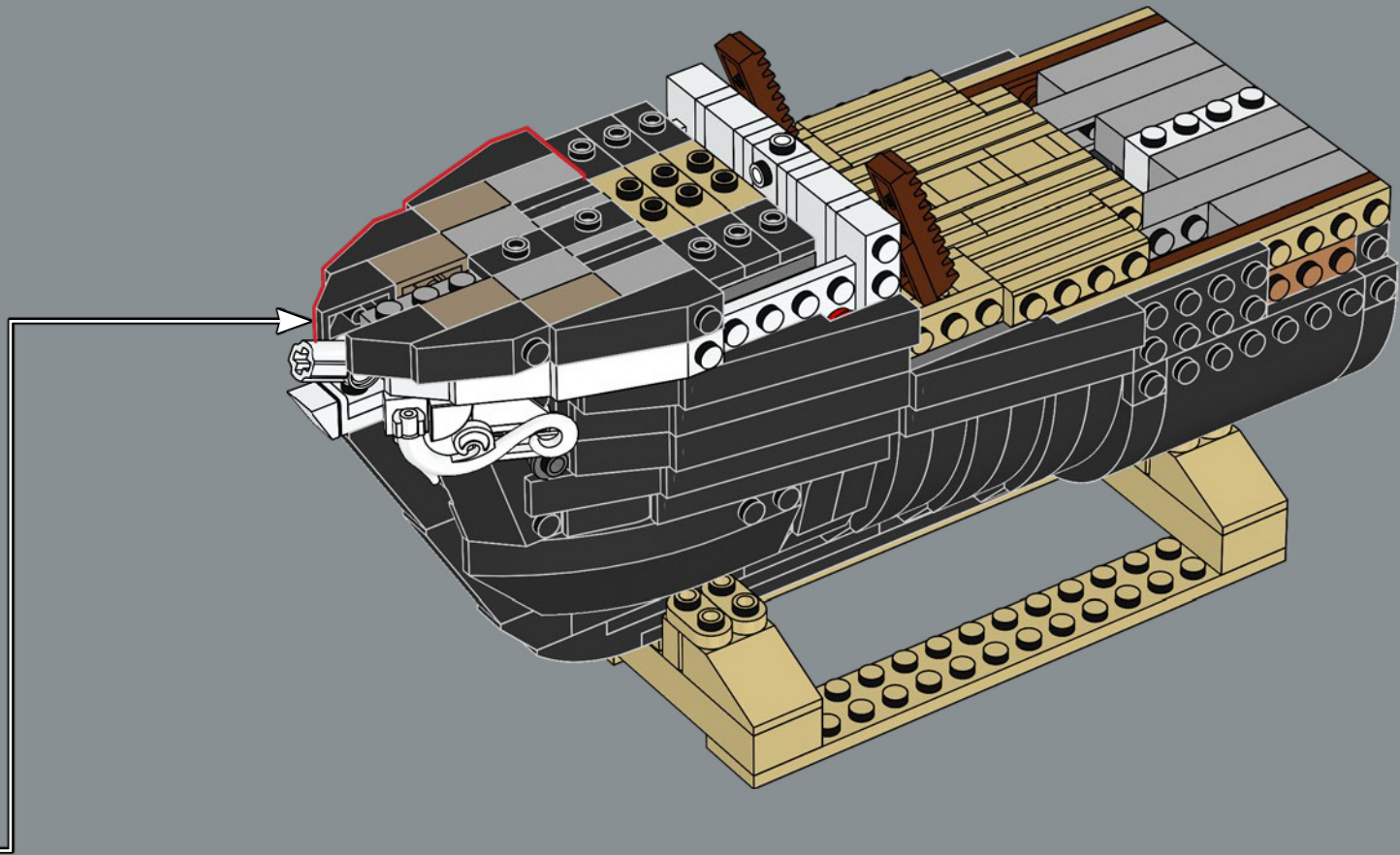



1x

99

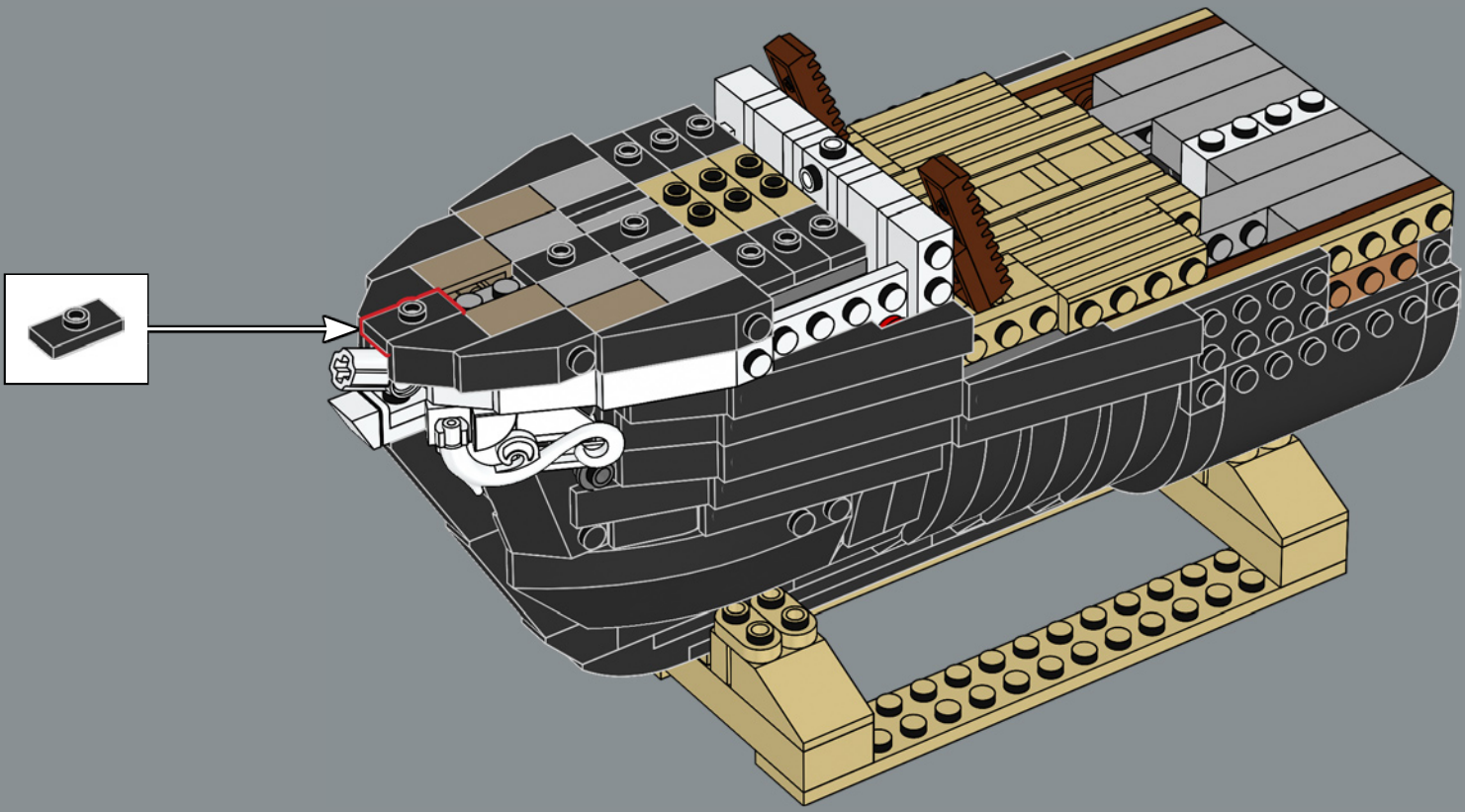

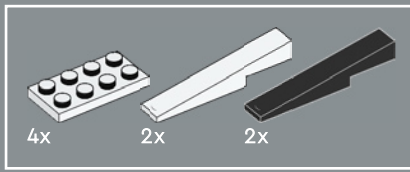

100

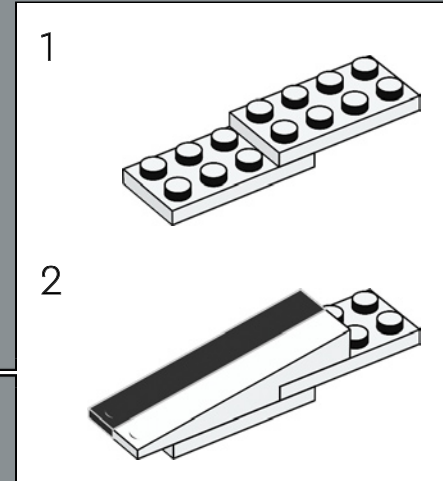
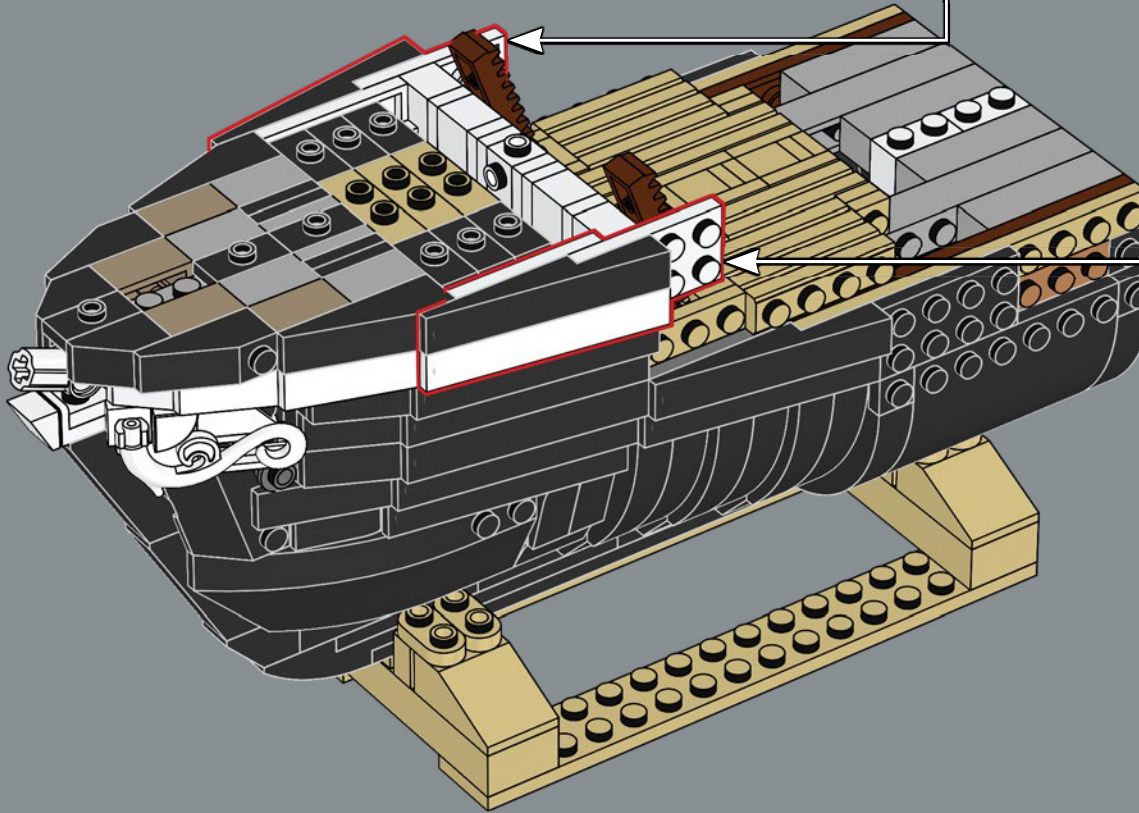
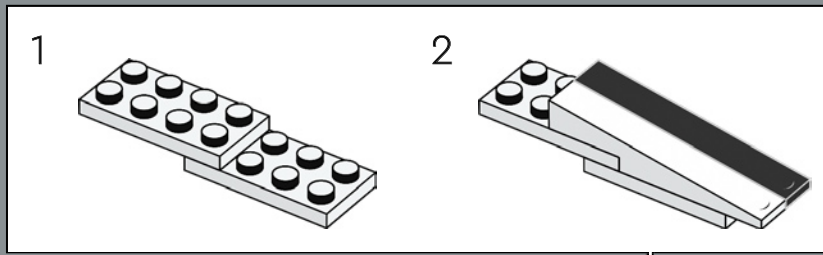

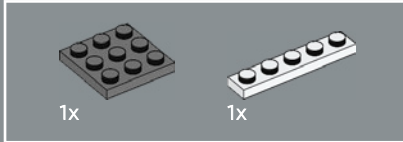
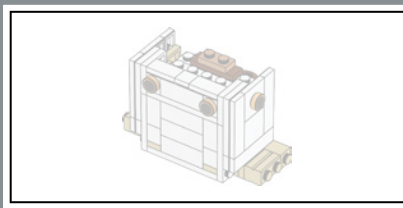

101

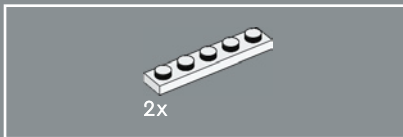
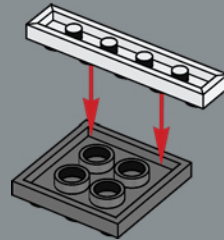

102

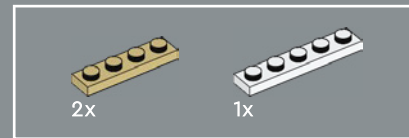
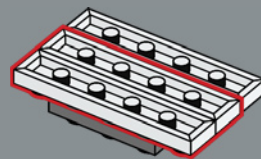

103

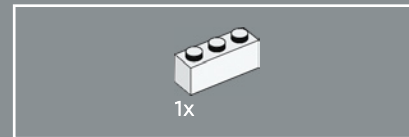
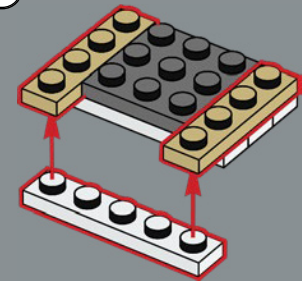

104

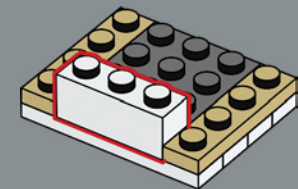

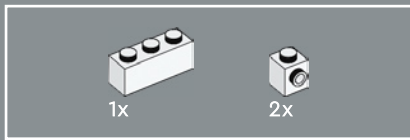

105

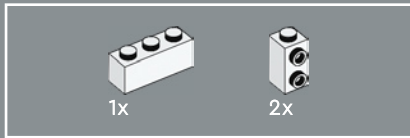
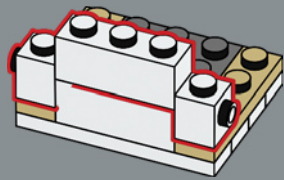

106

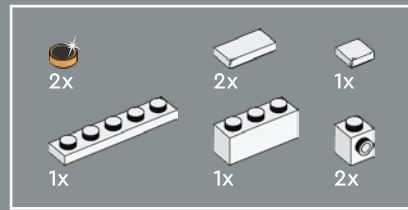
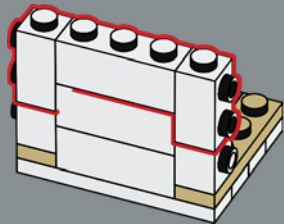

107

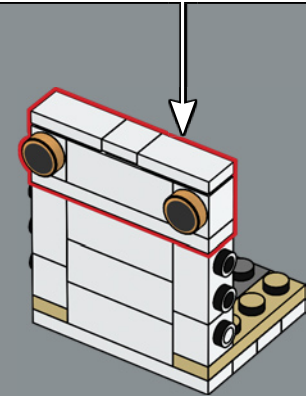
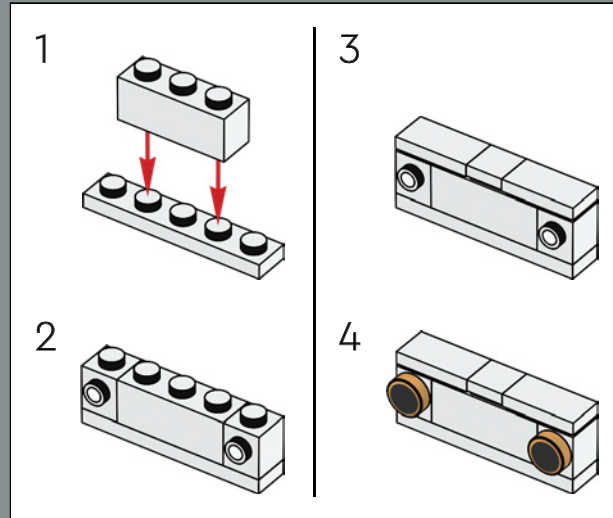



2x

108

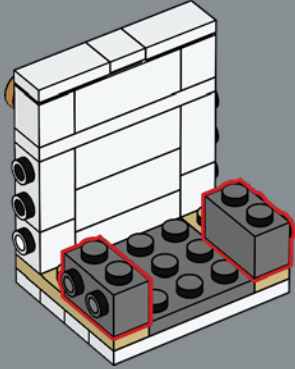

2x

109

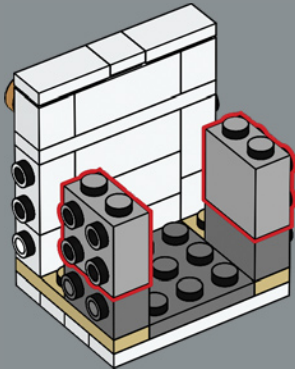

1x

2x

2x

1x

110

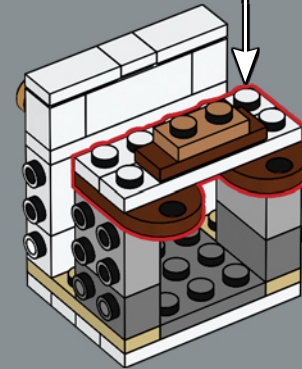
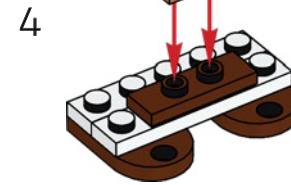
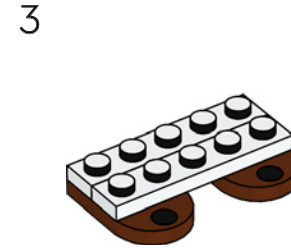
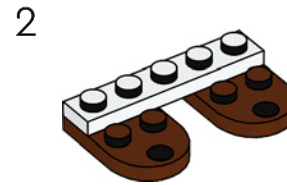
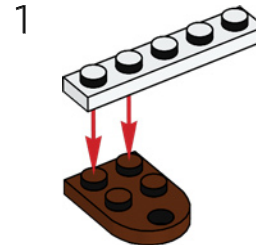

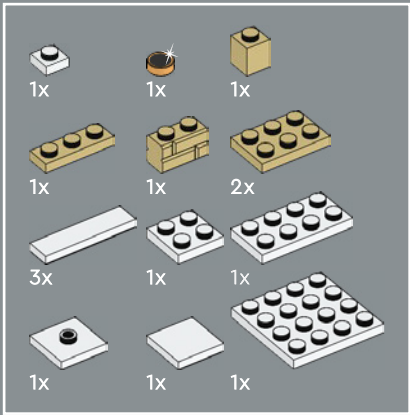

112

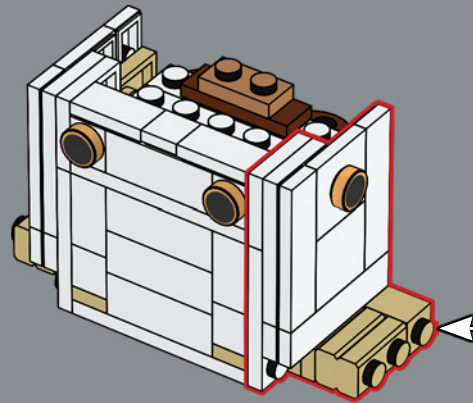
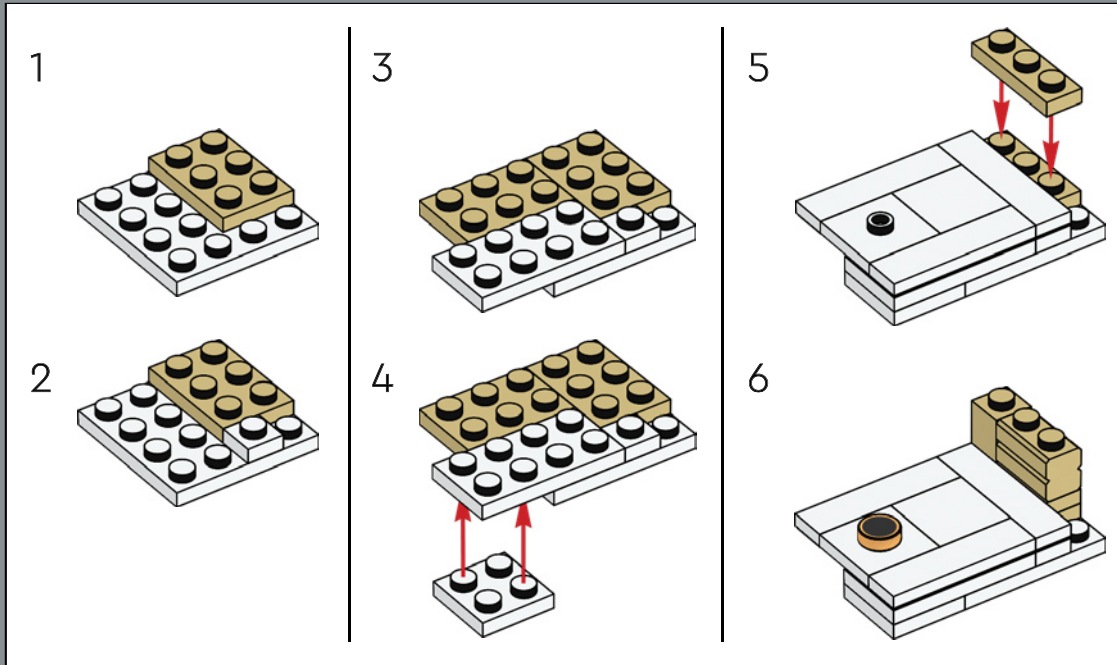

113

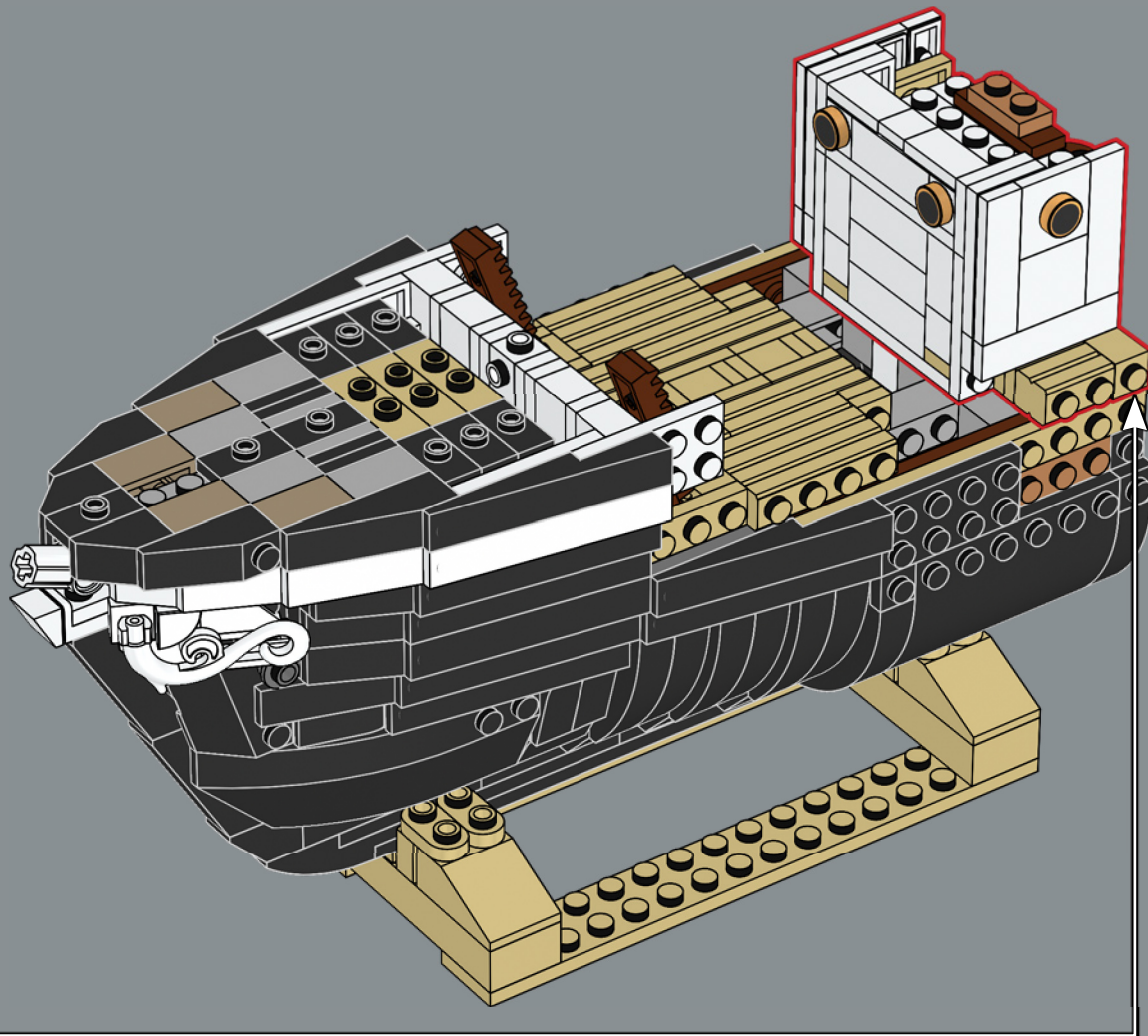

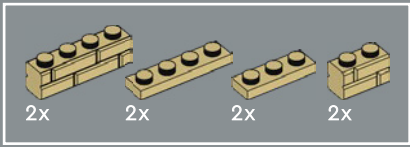

114

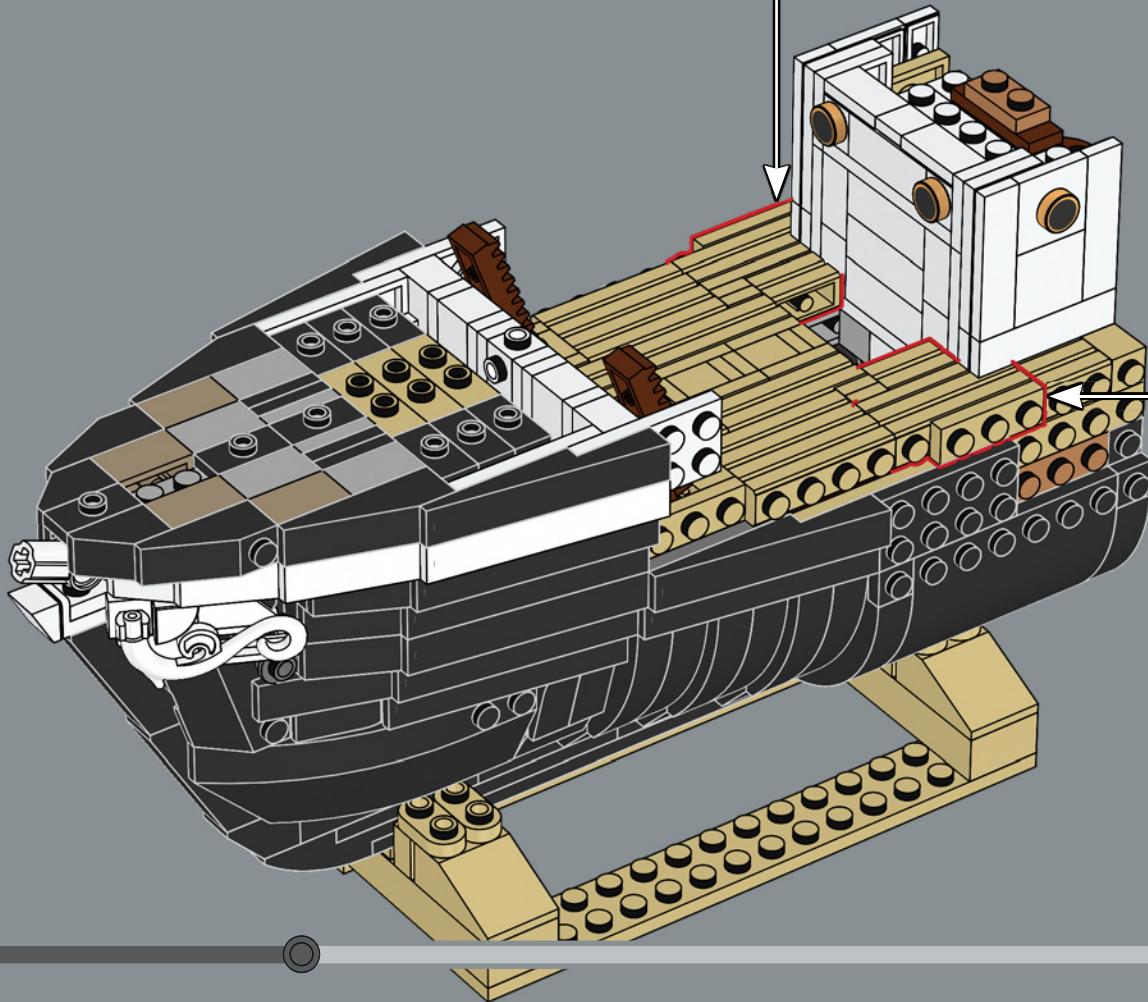
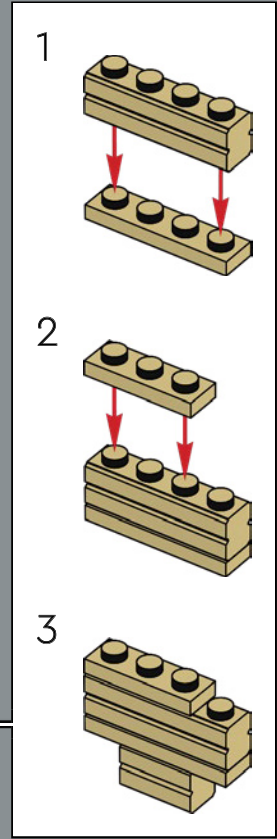
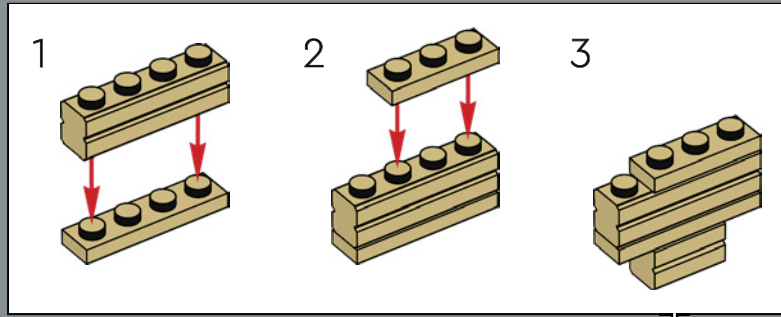

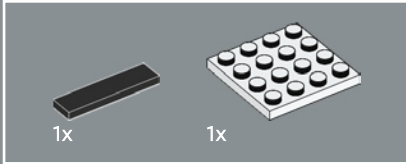
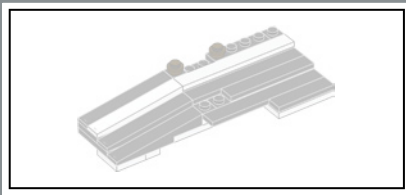

115

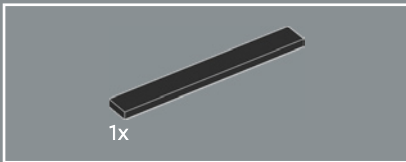
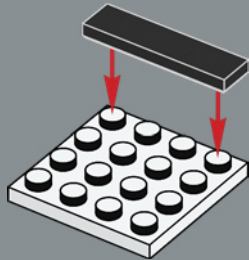

116

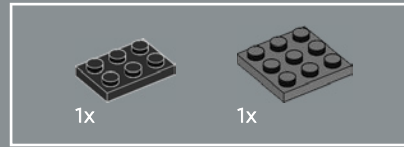
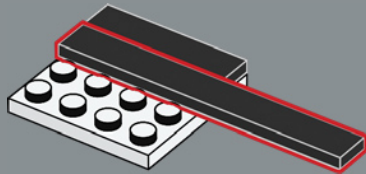

117

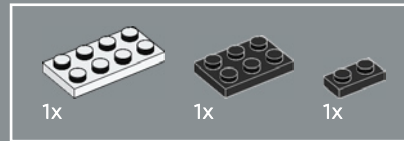
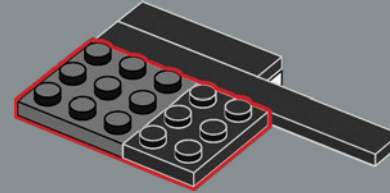

118

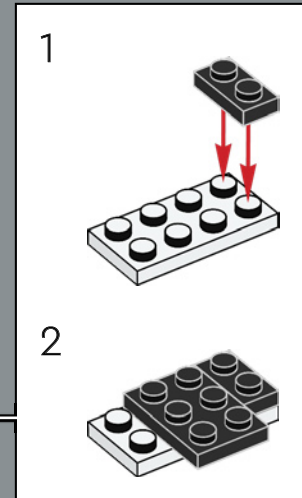
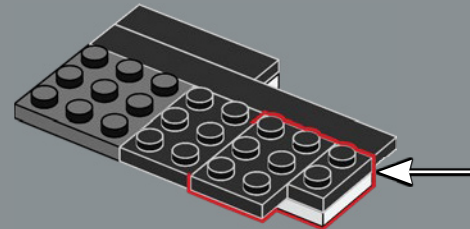

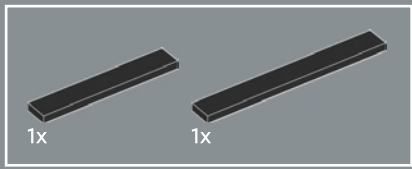

119

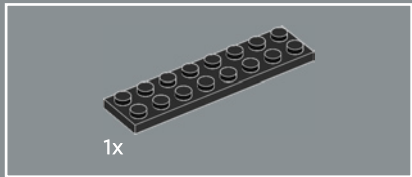
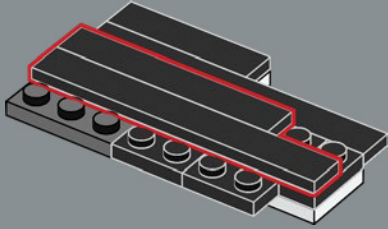

120

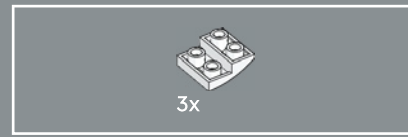
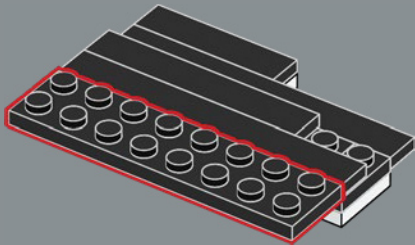

121

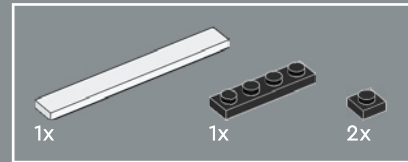
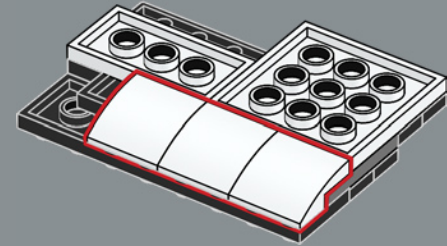

122

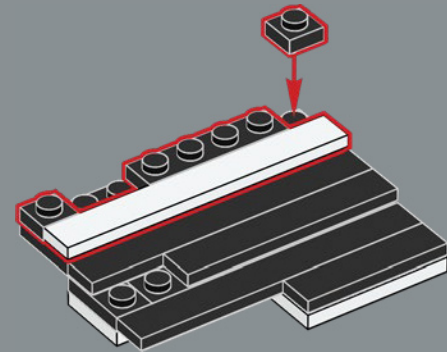



123

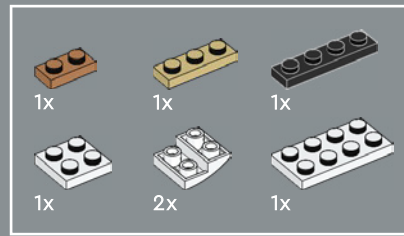
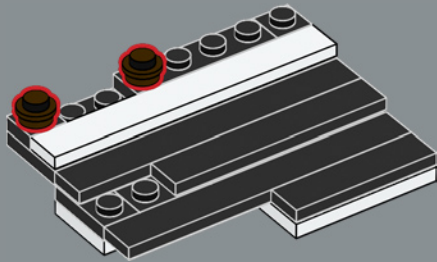

124

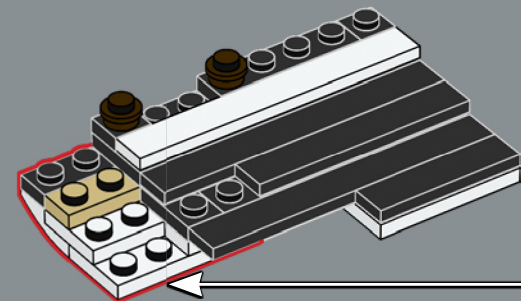
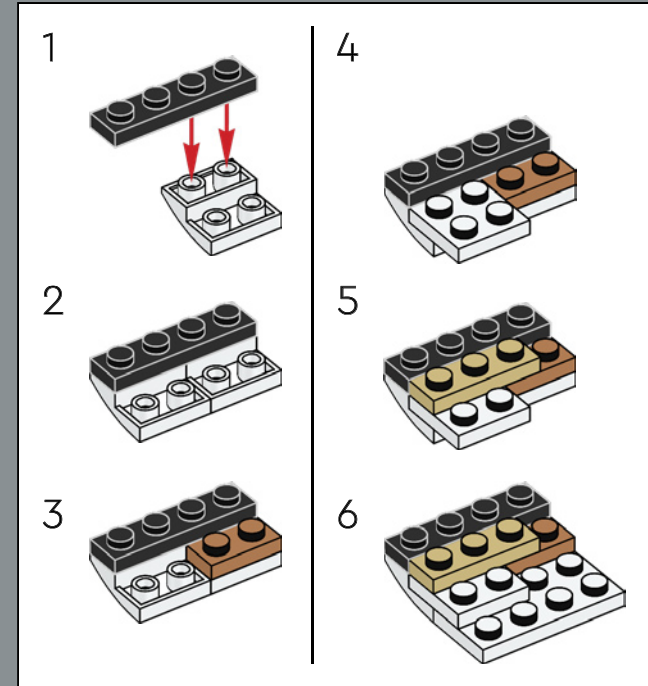

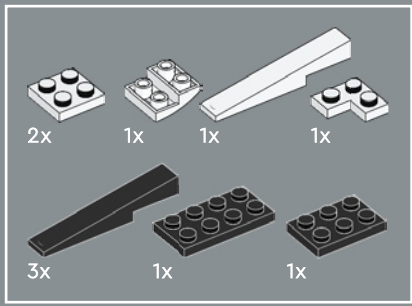

125

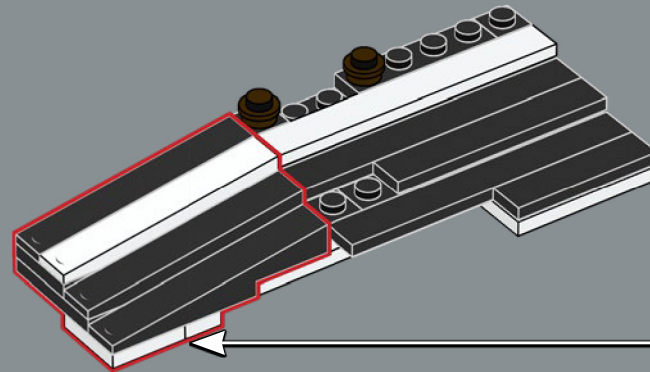
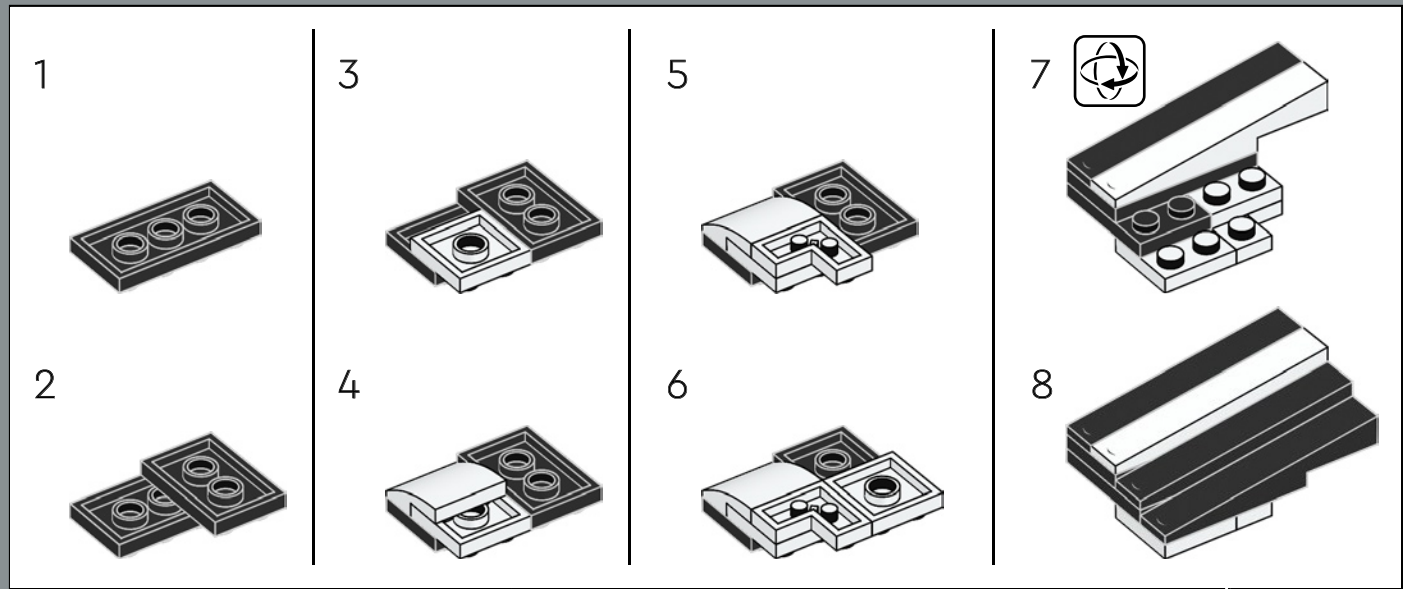

126

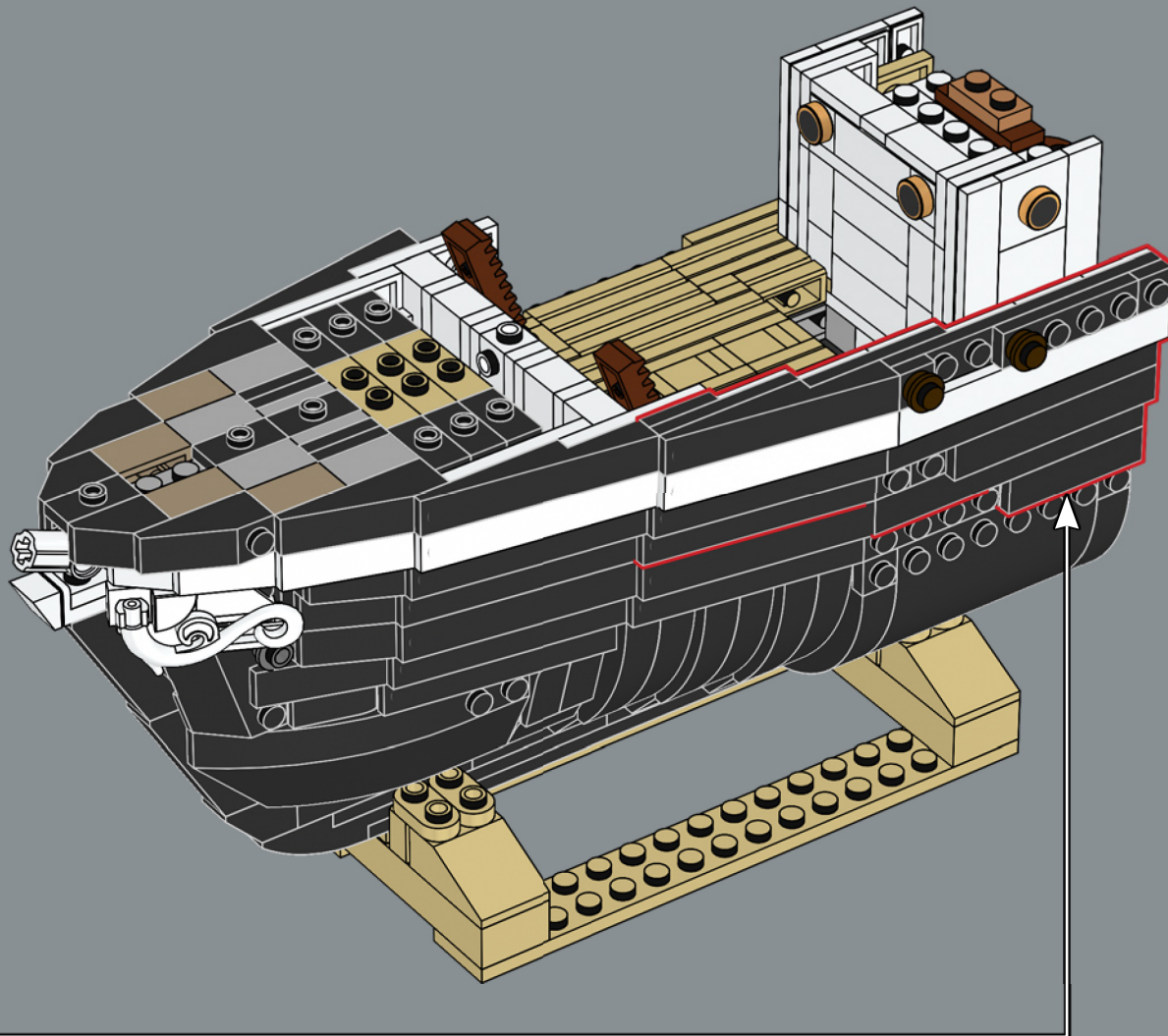

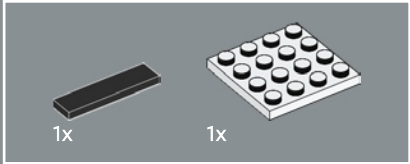
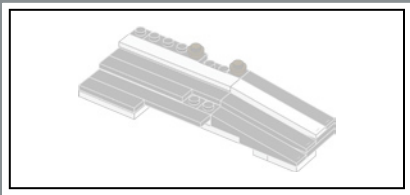

127

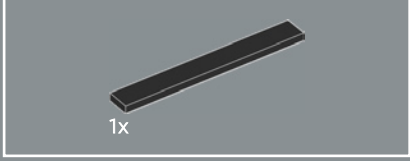
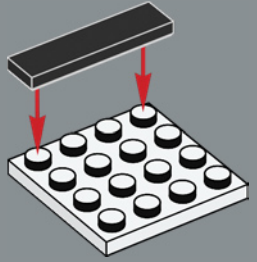

128

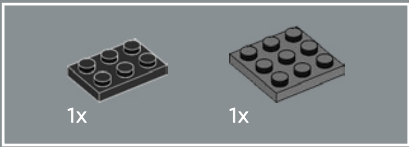
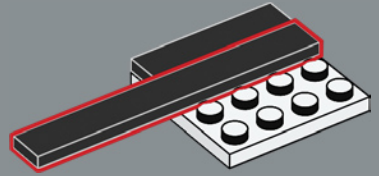

129

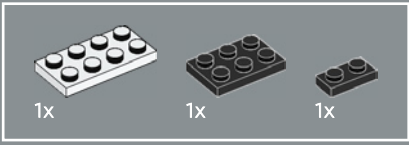
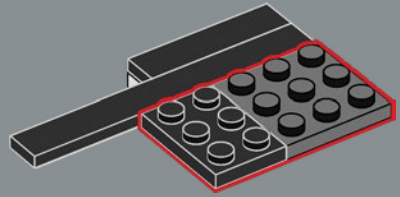

130

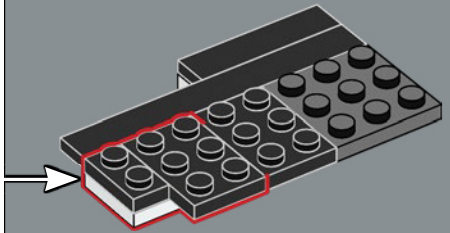
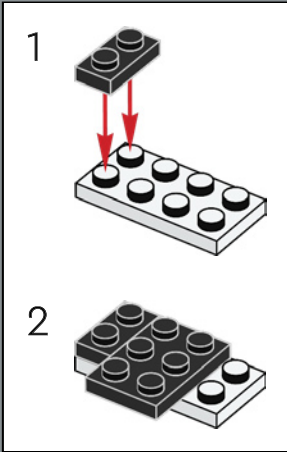

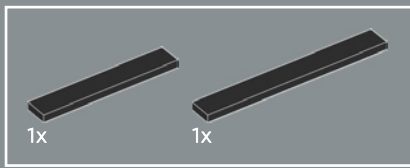

131

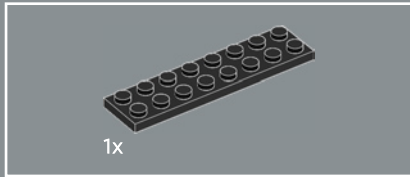
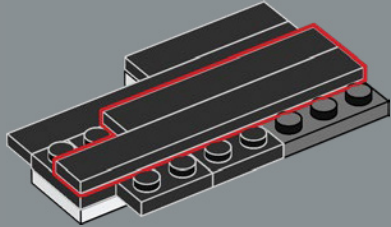

132

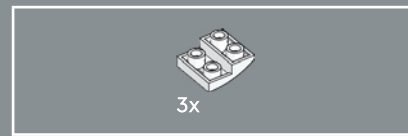
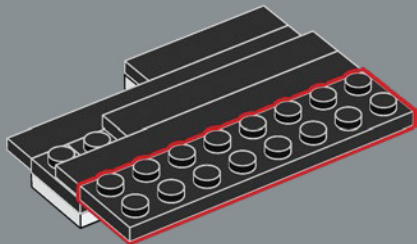

133

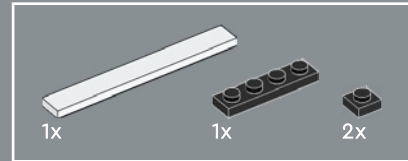
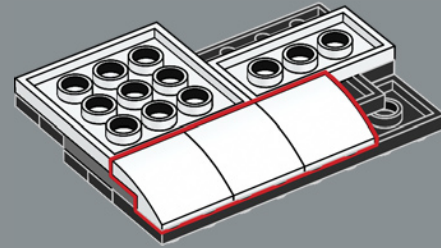

134

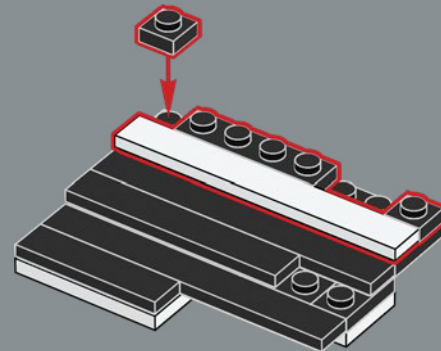

2x

135

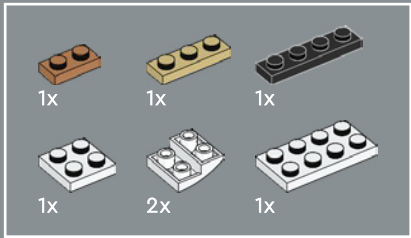
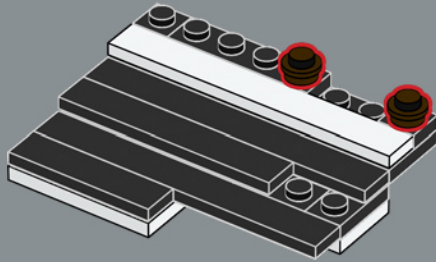

136

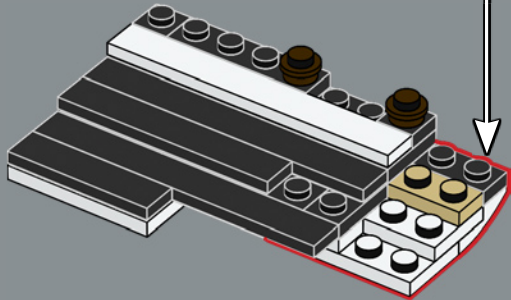
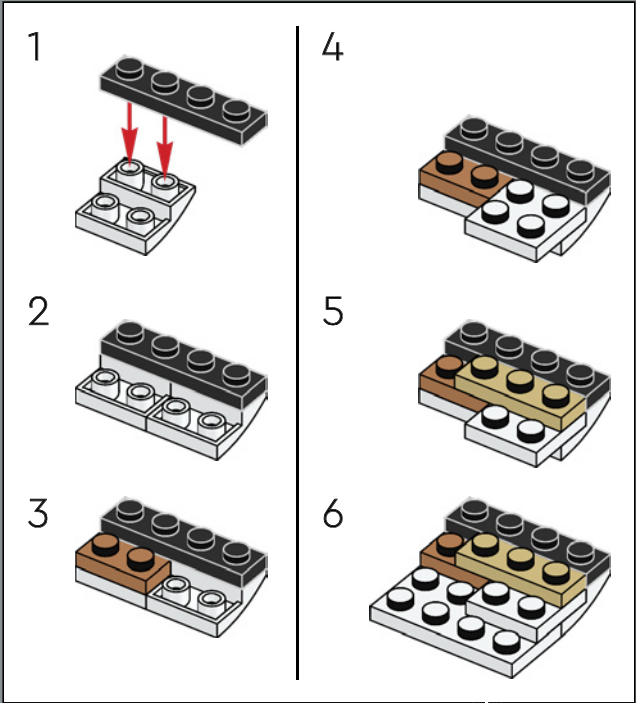

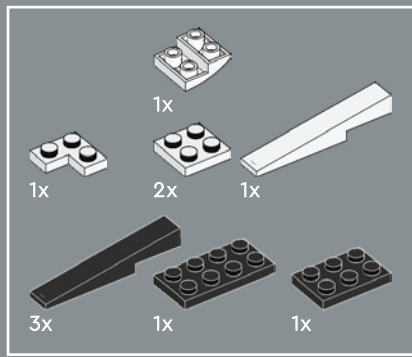

137

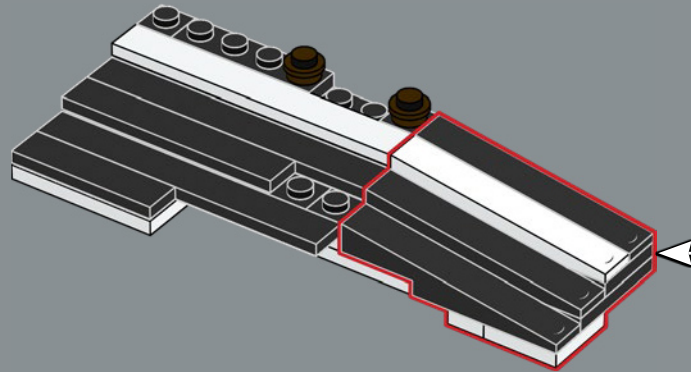
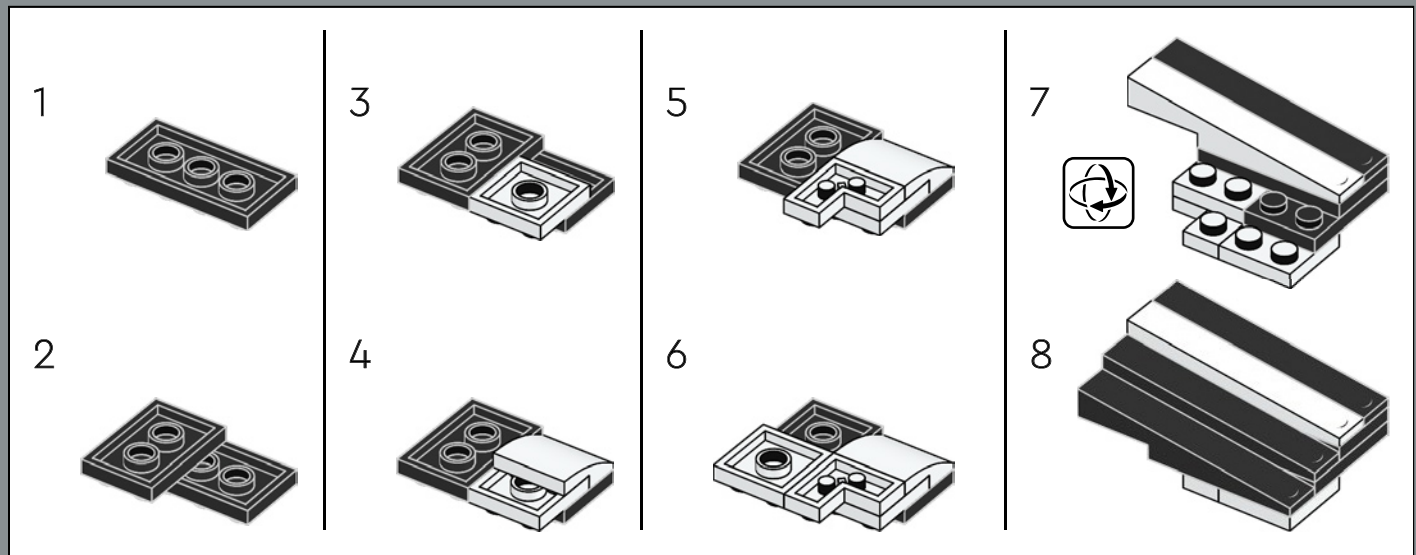

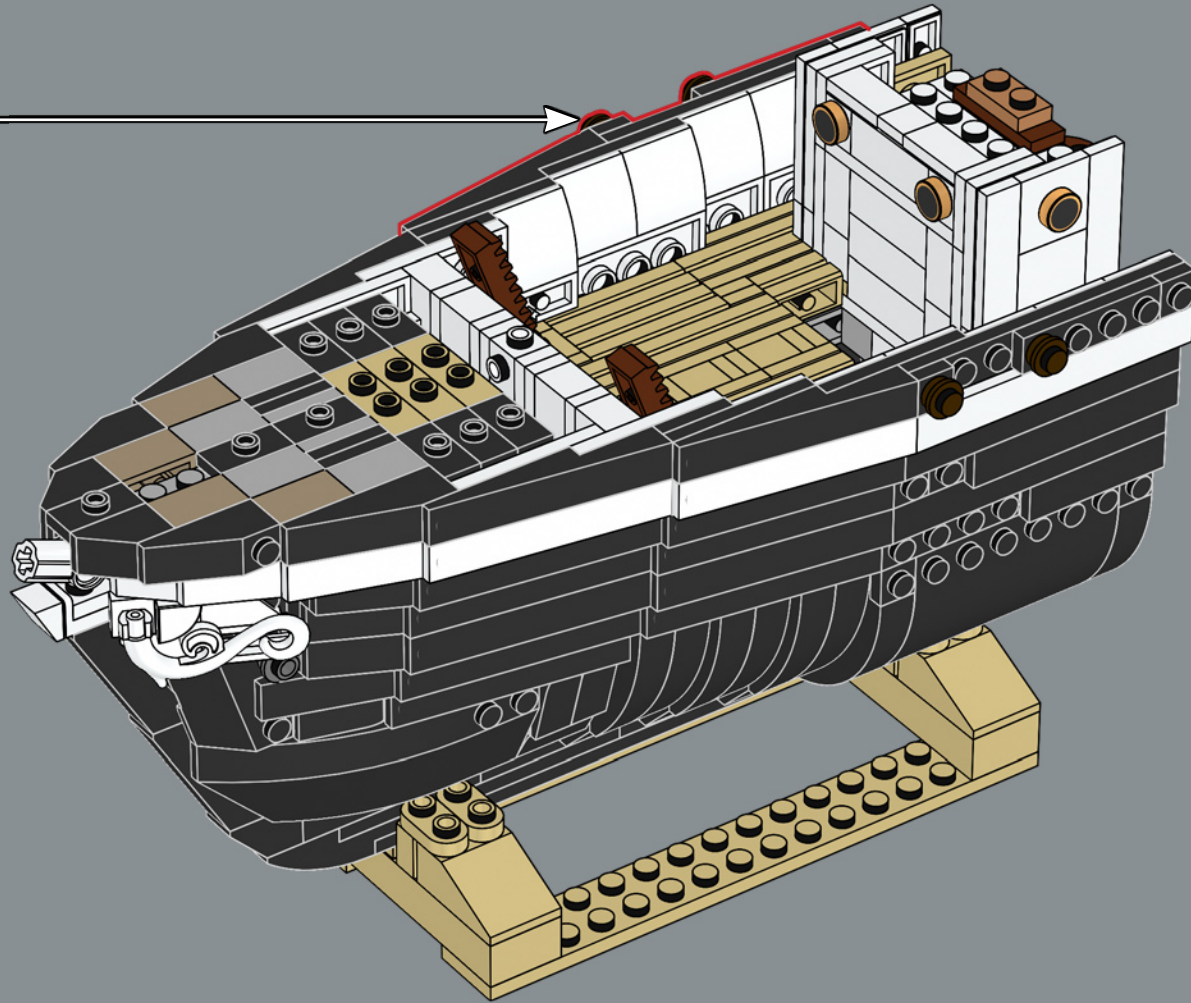

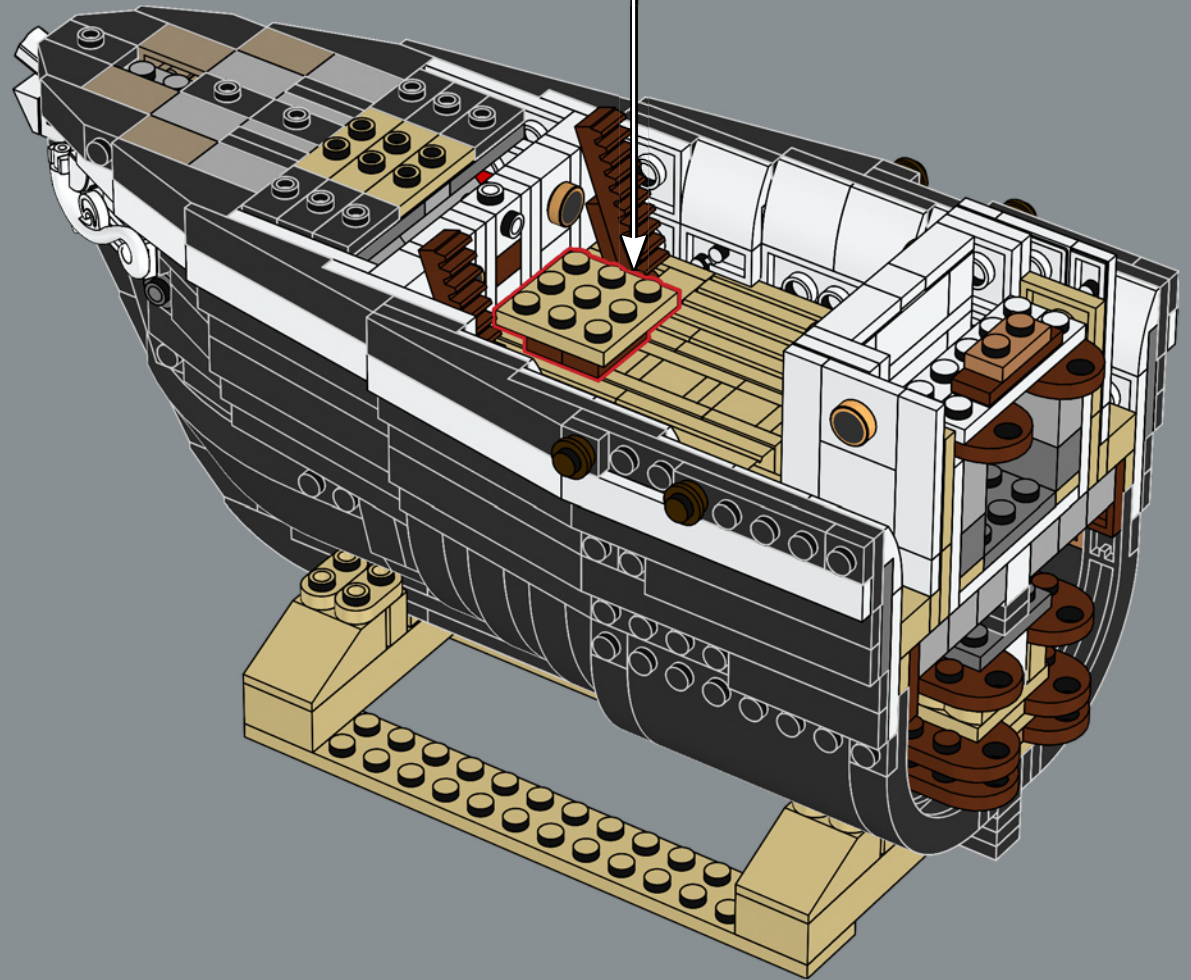
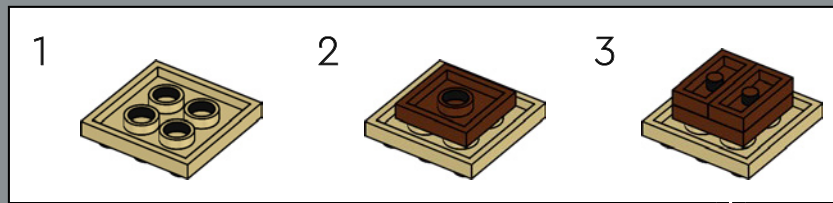
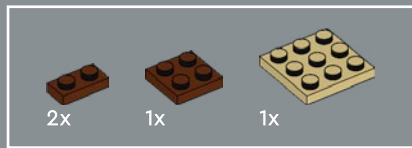

139

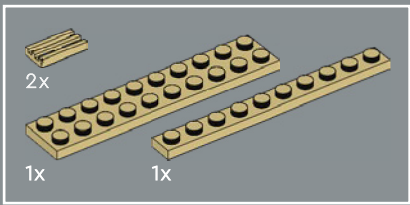

140

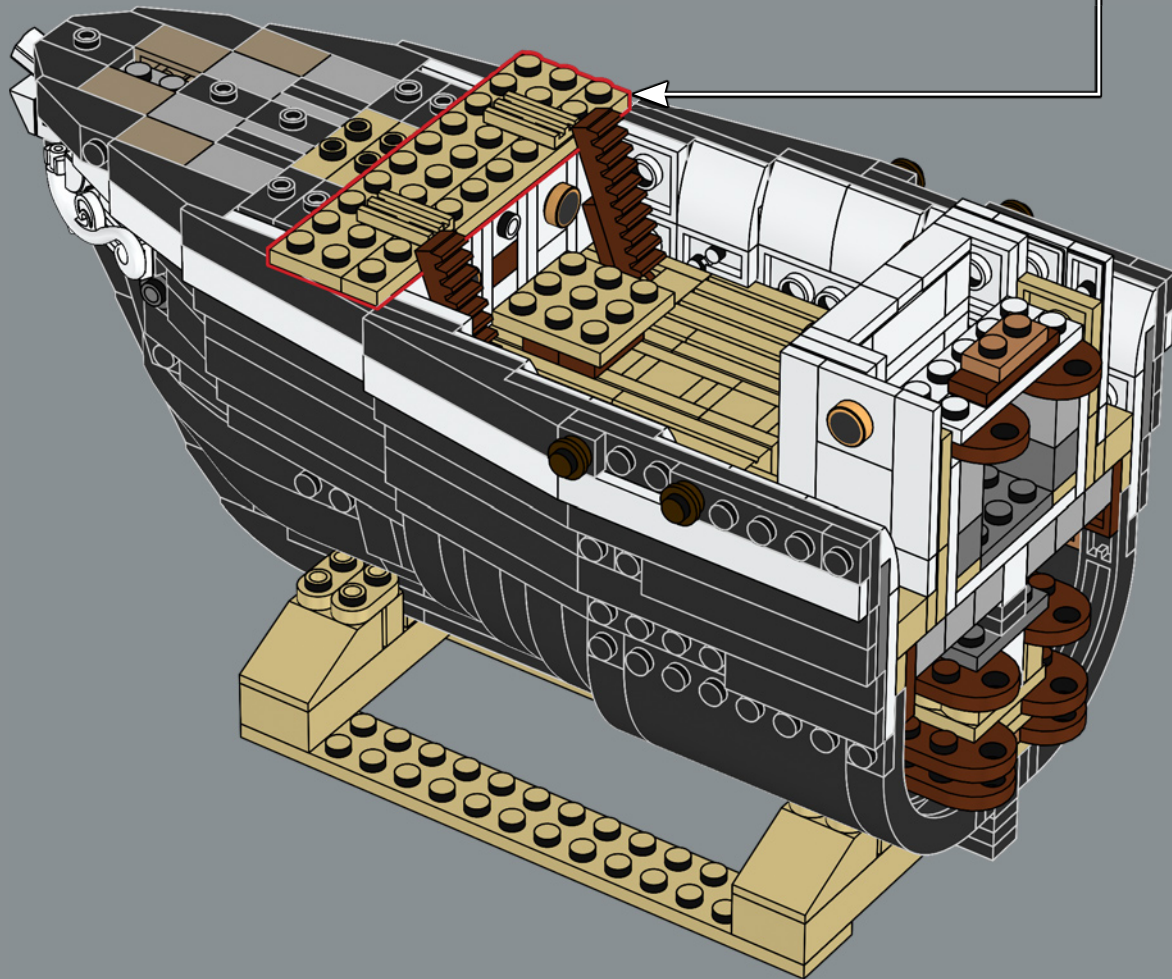
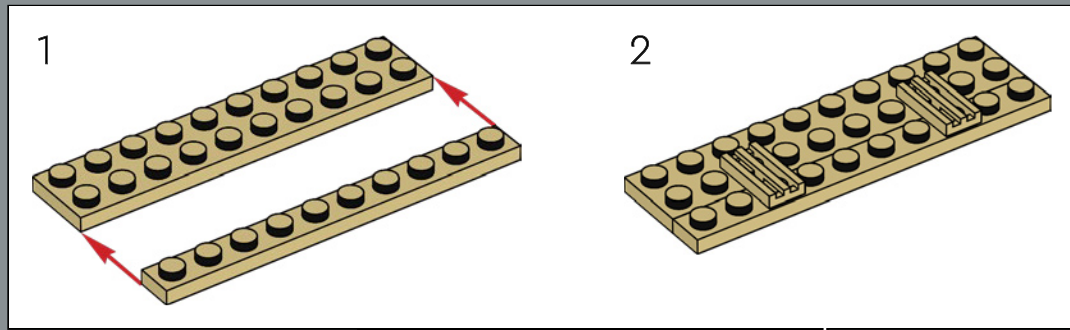

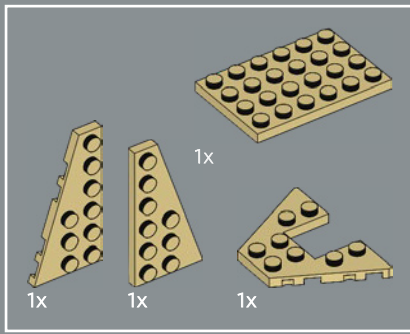

141

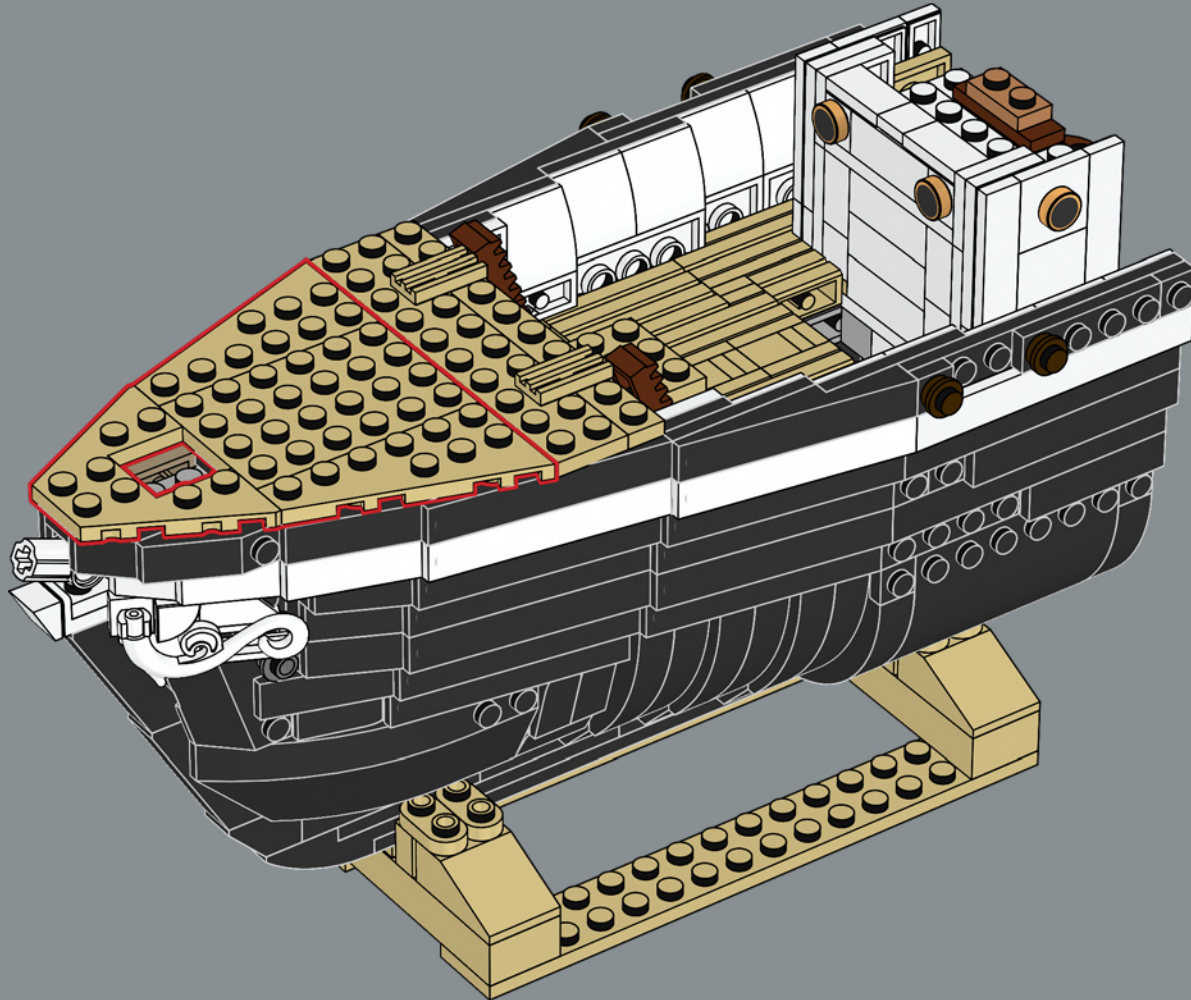

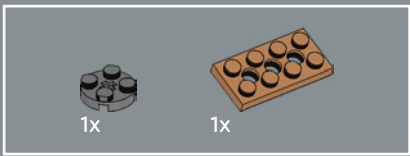

142

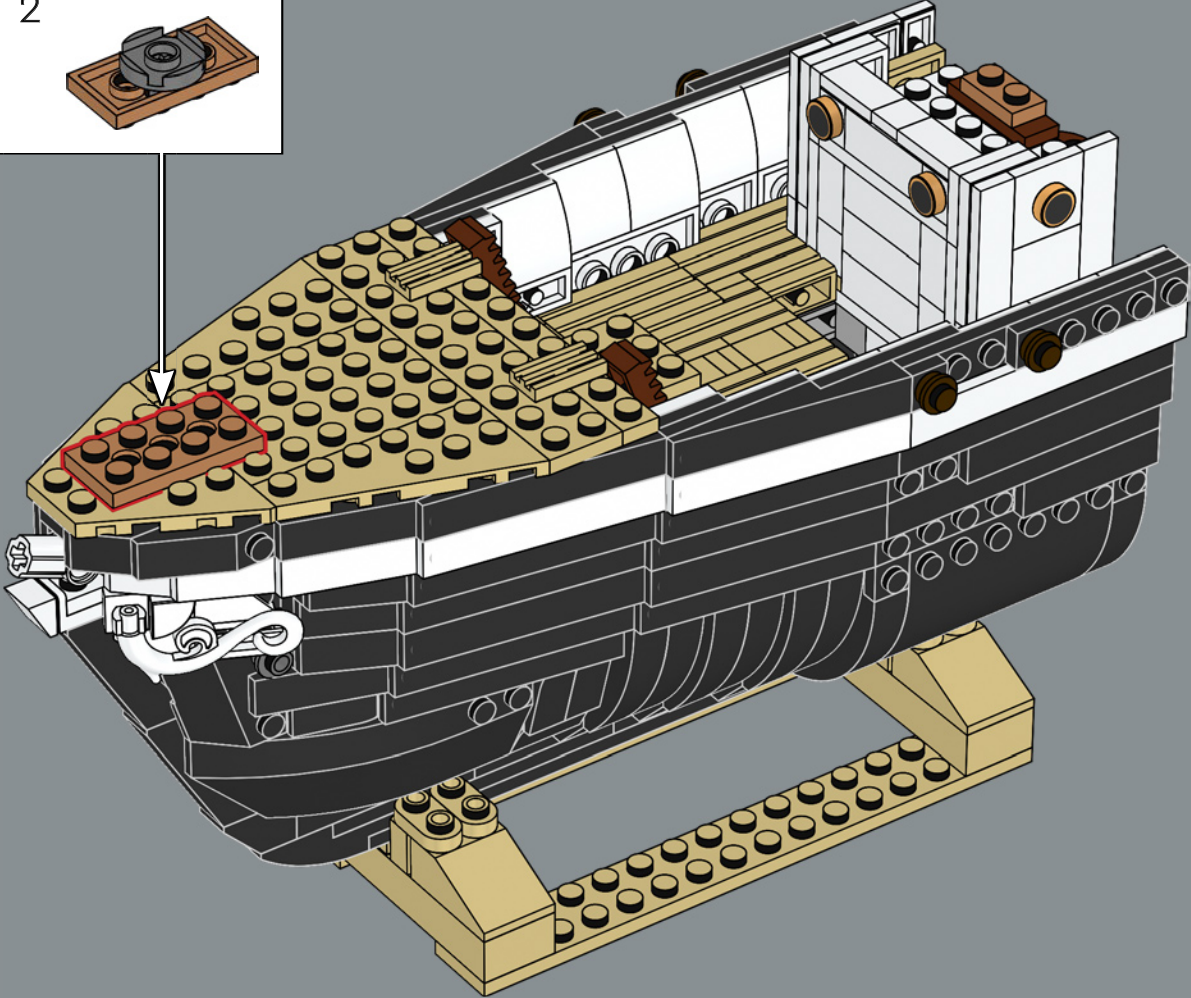
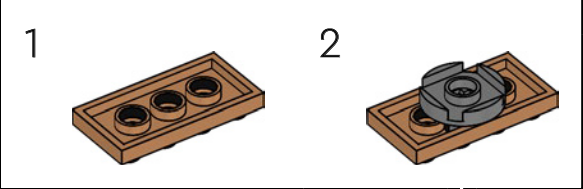

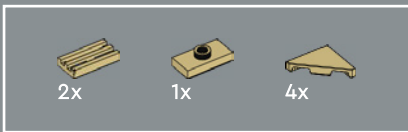

143

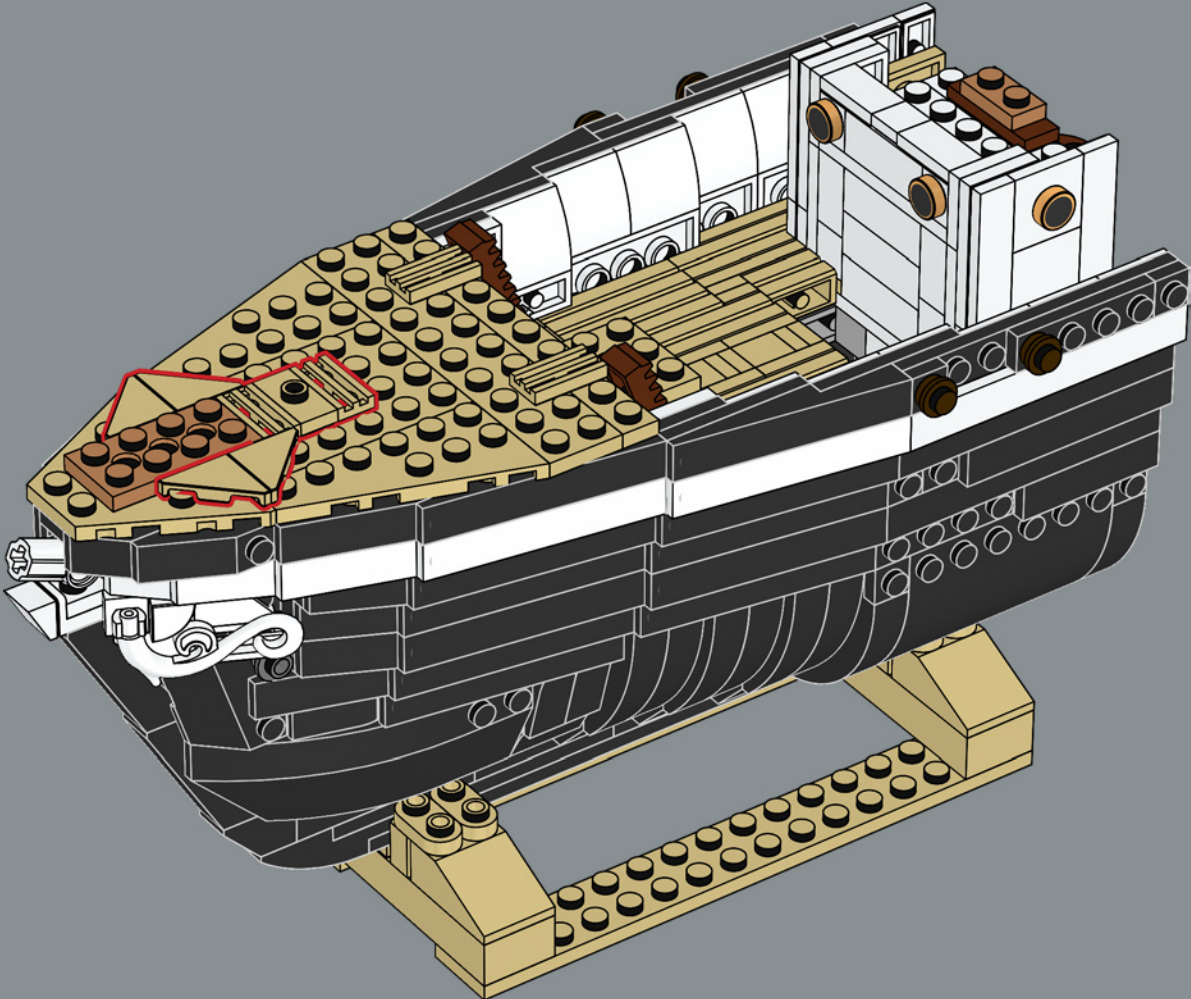



144

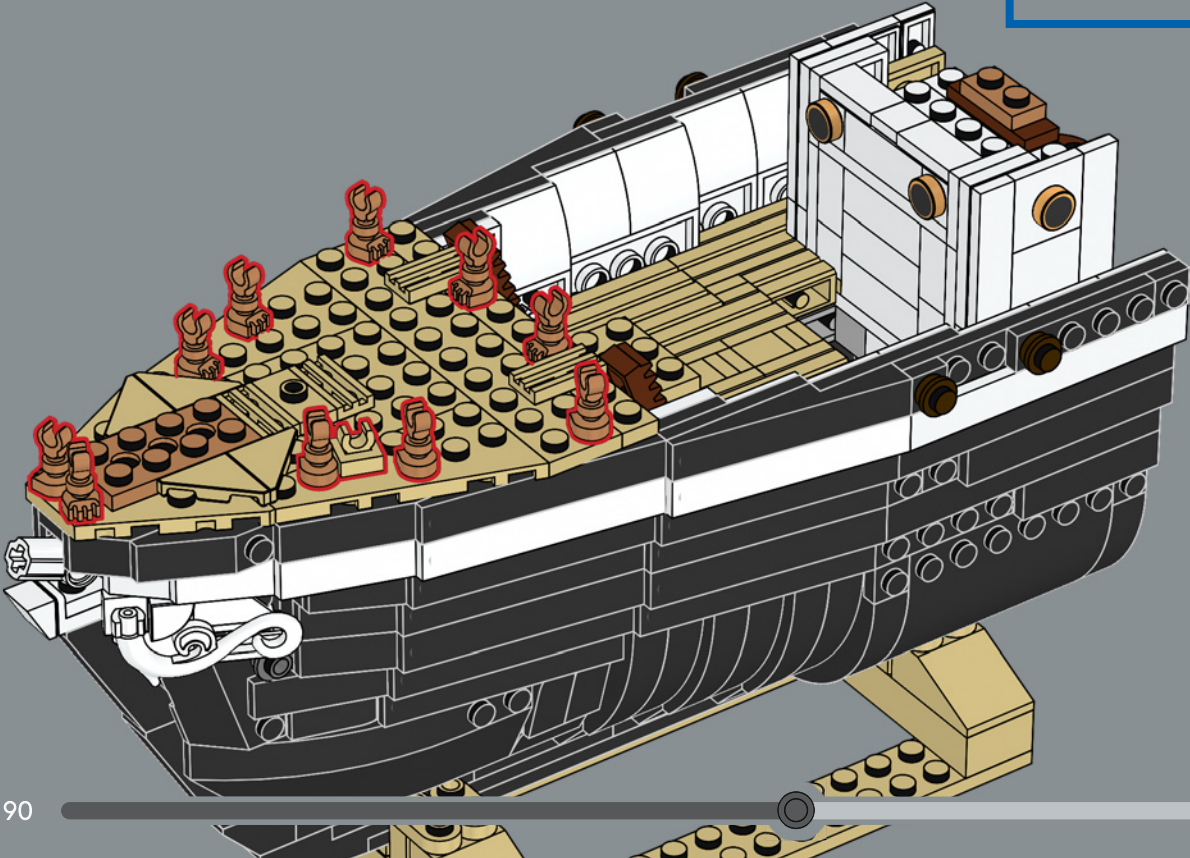
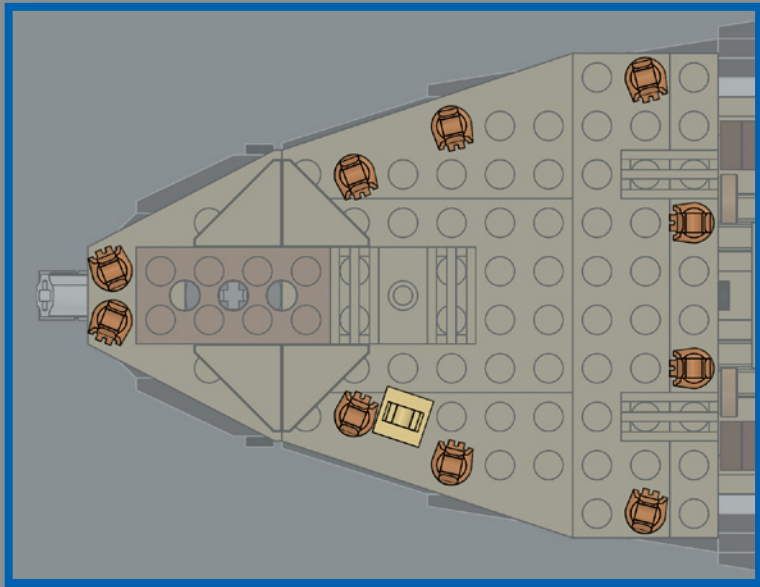



145

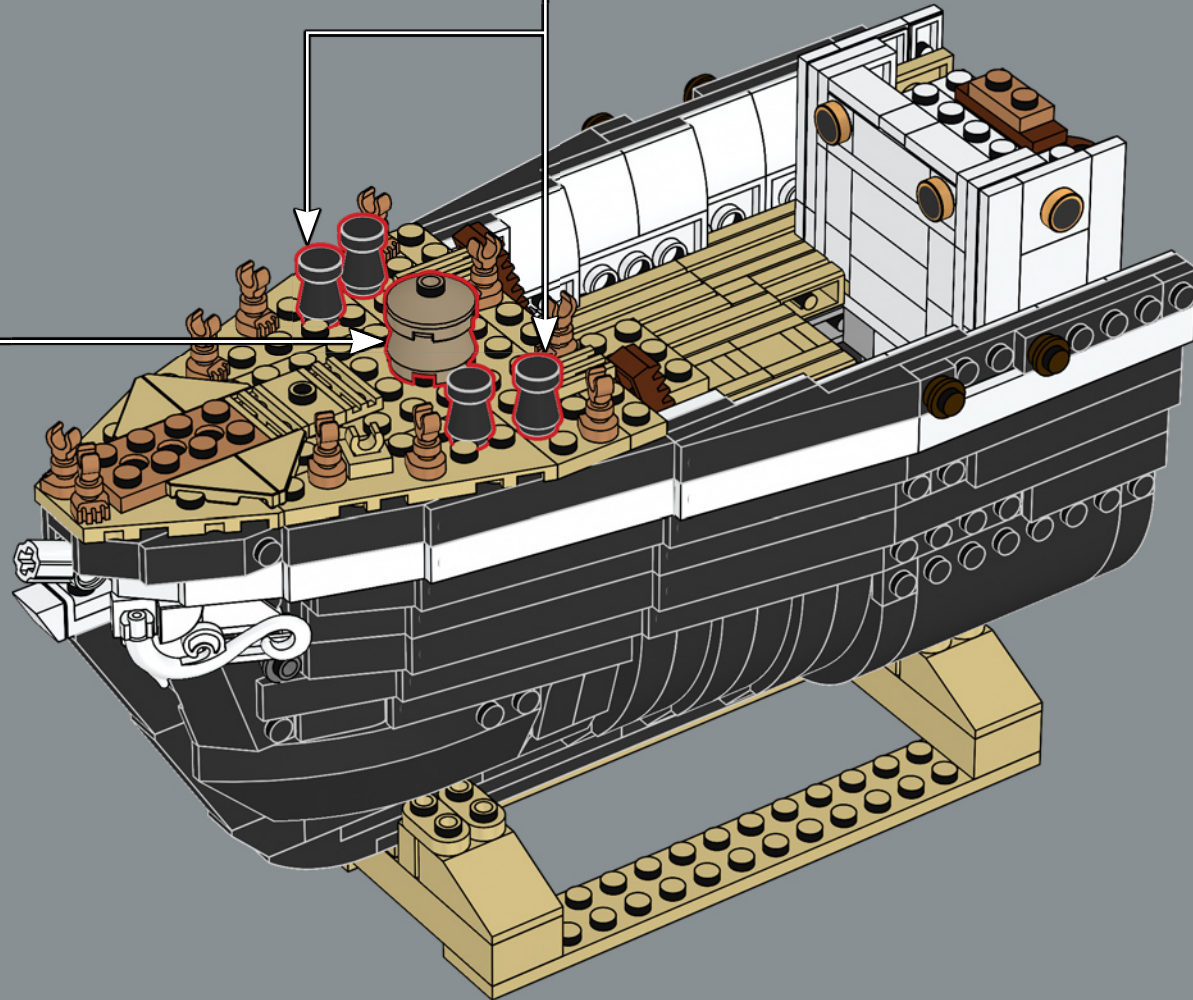
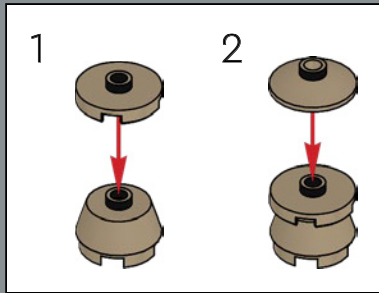
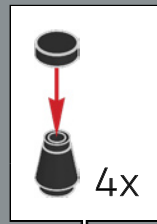

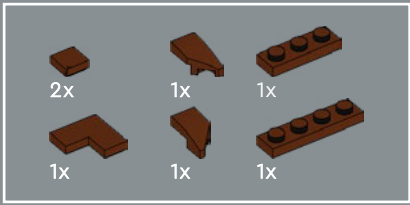

146

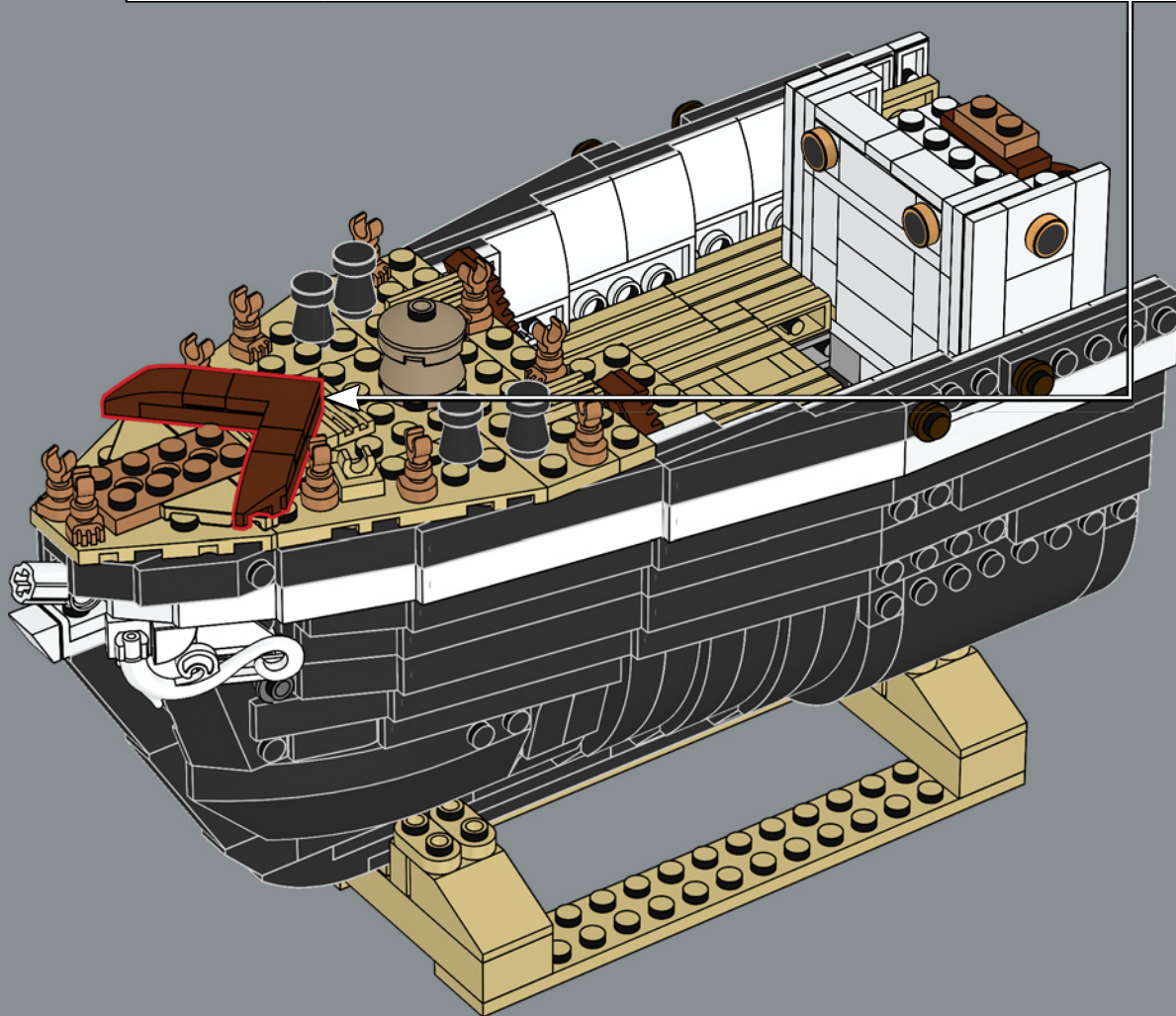
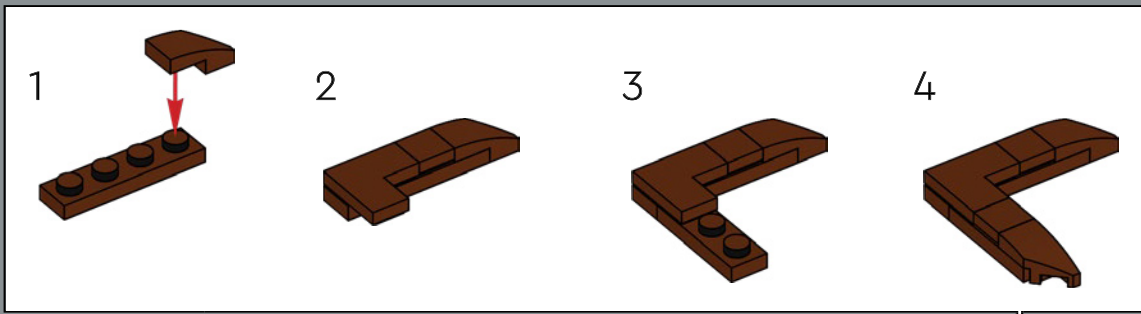

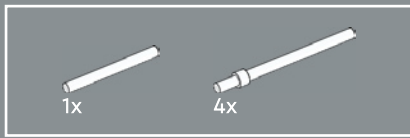

147

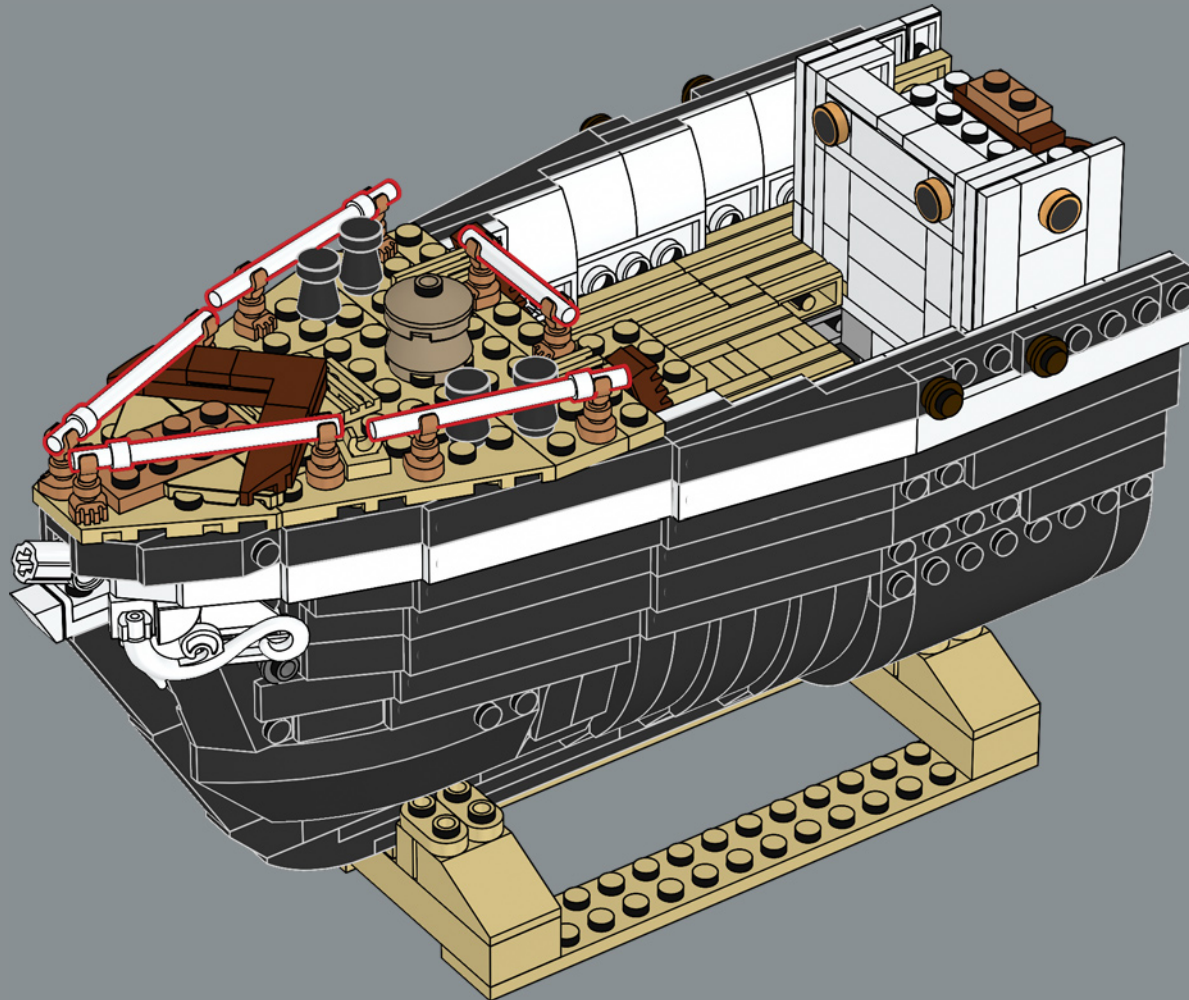



148

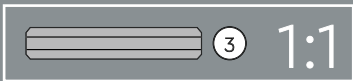
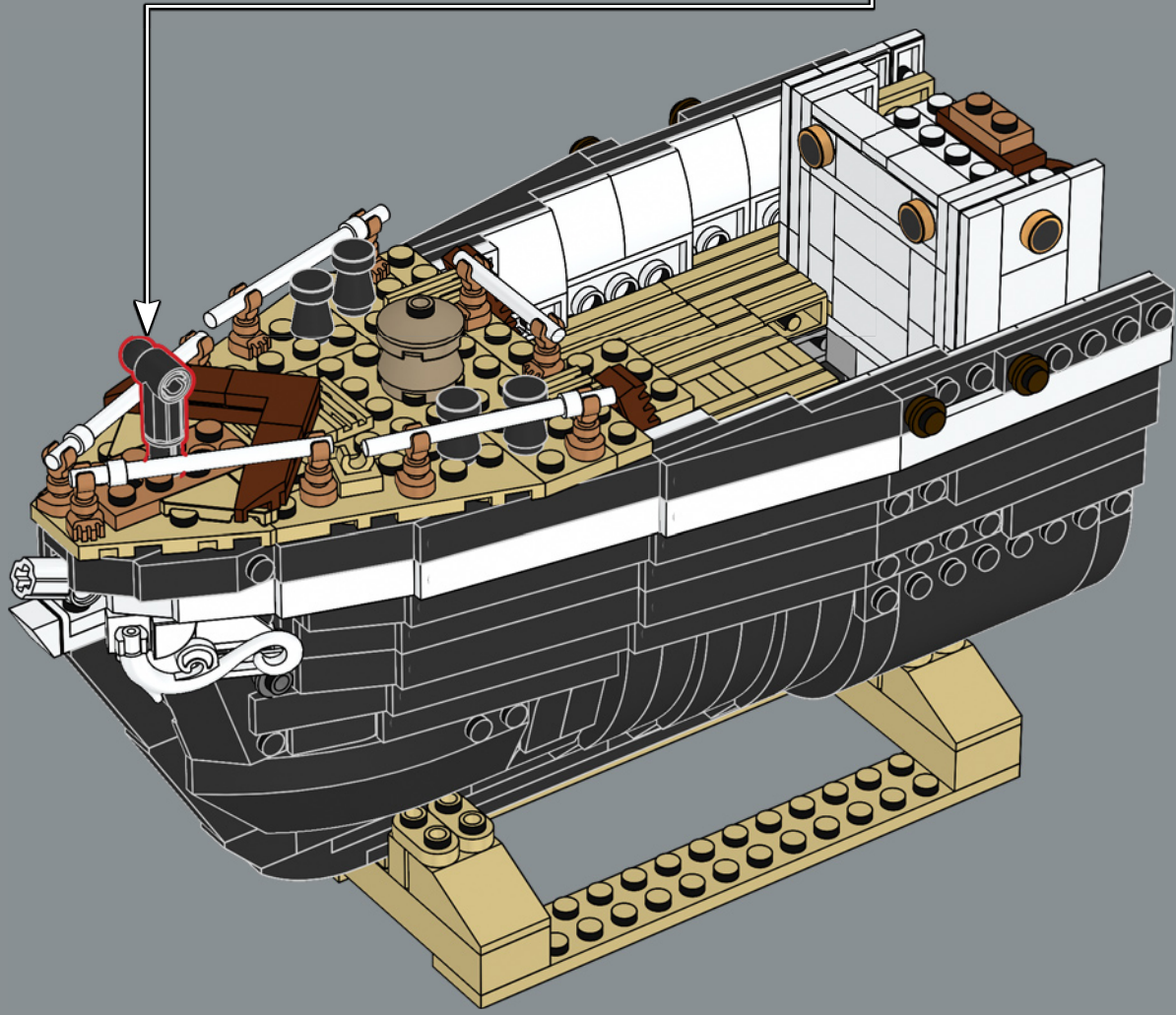
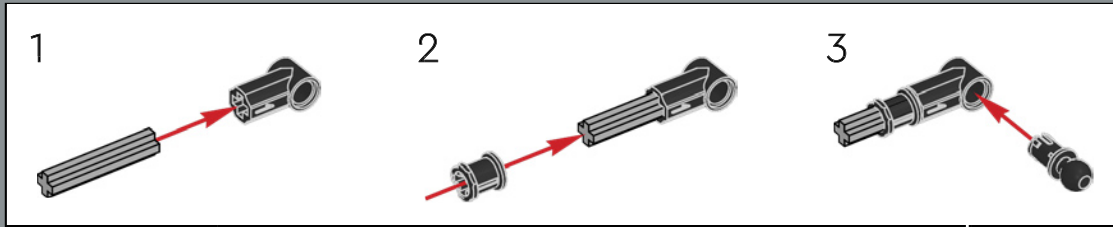

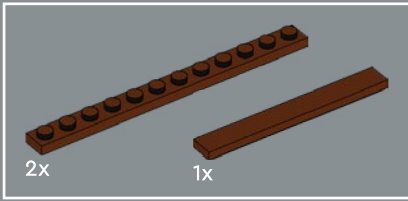
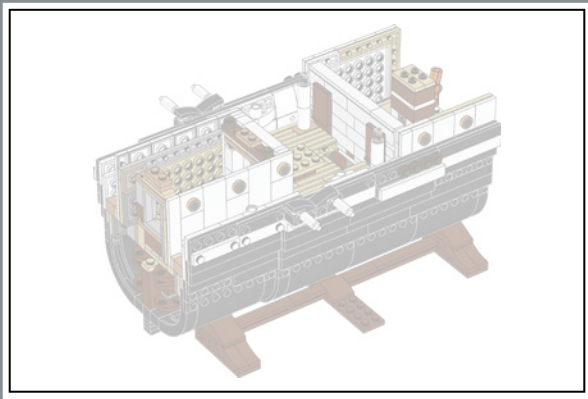

149

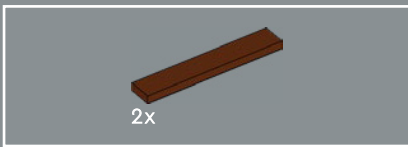
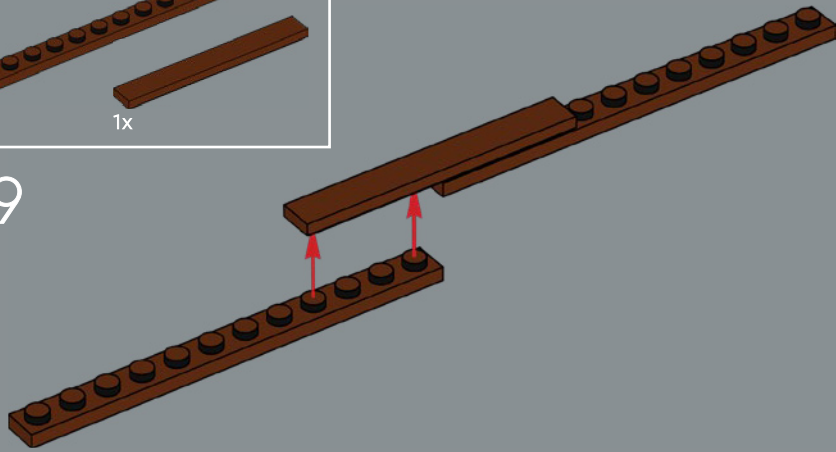

150

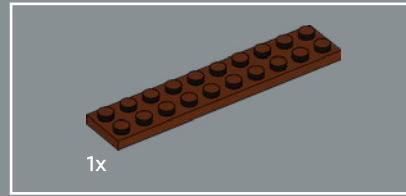
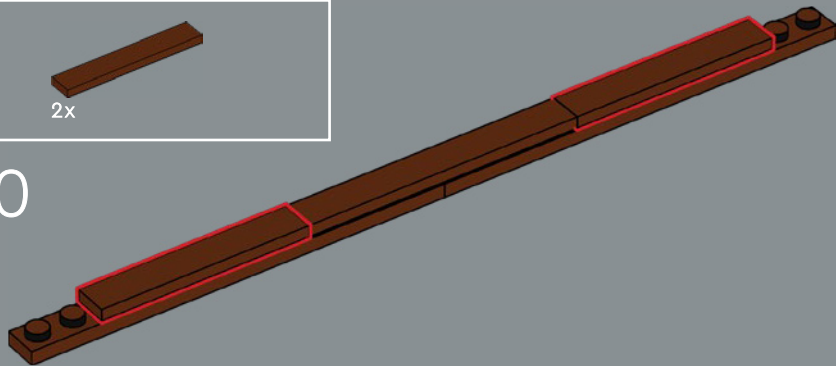

151

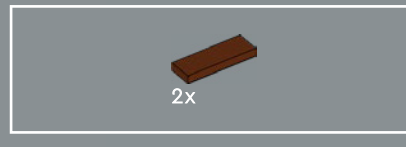
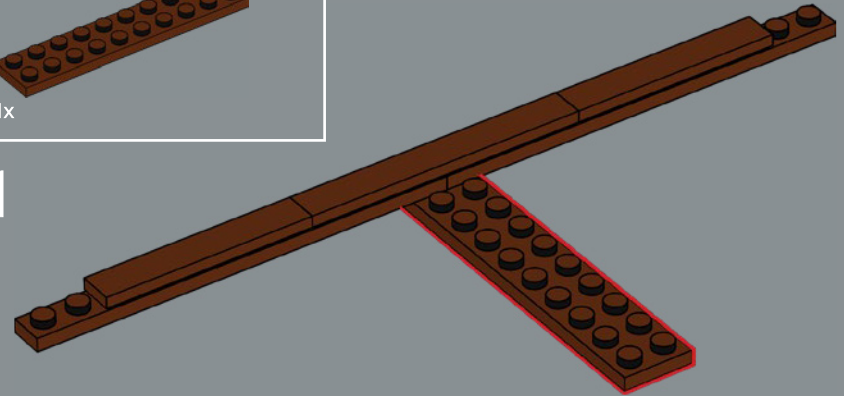

152

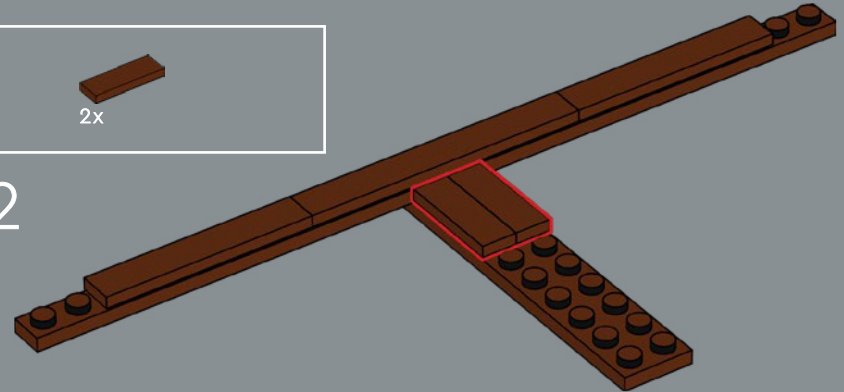

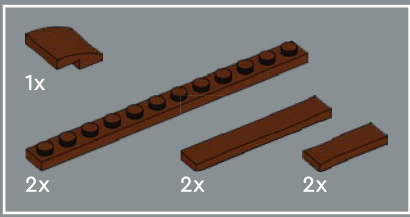

153

1

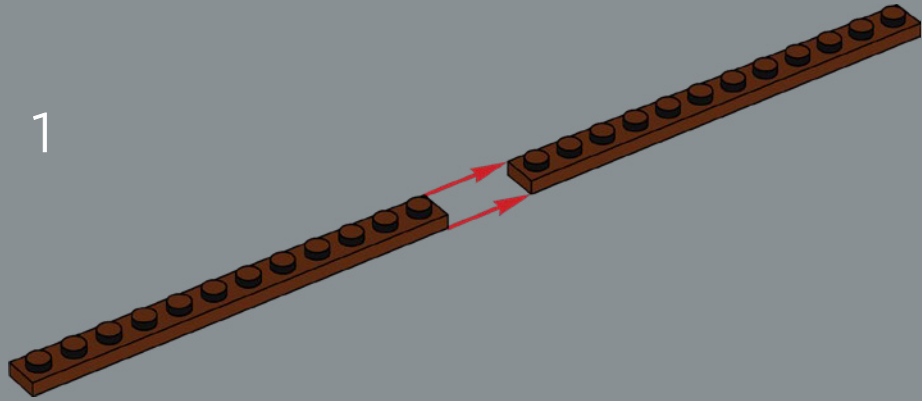

2

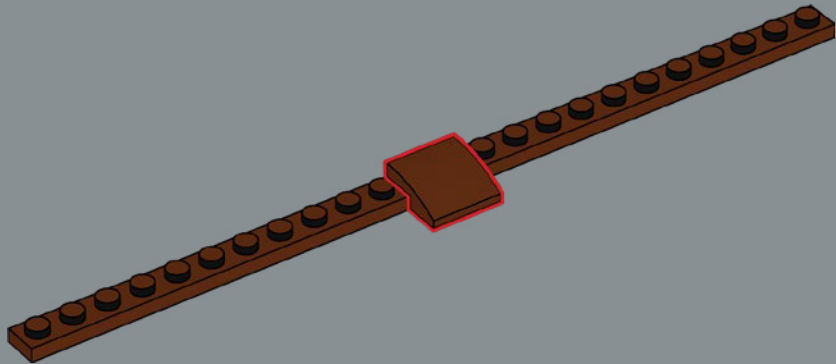

3

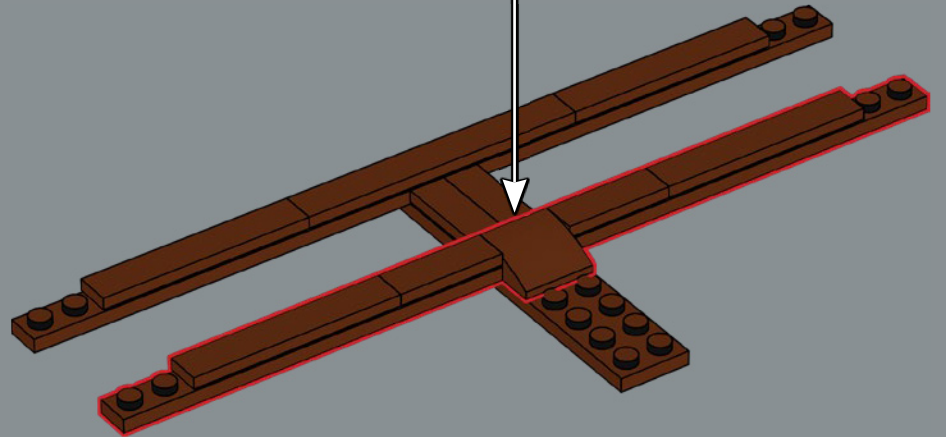
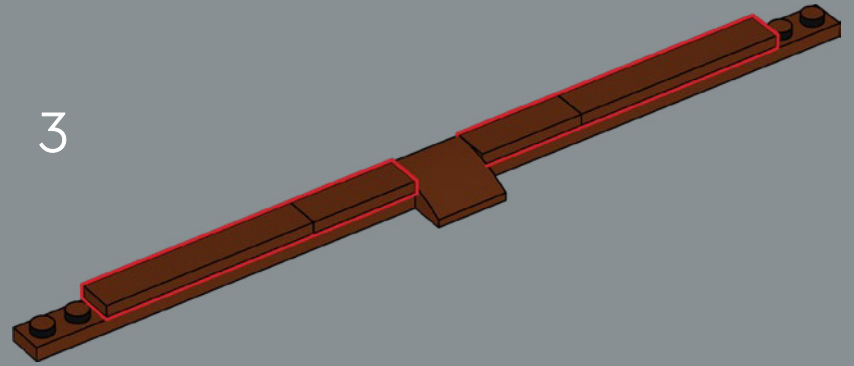

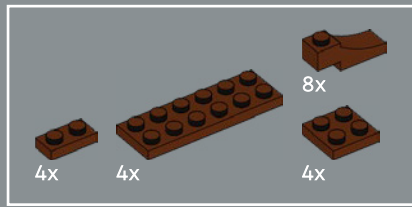

154

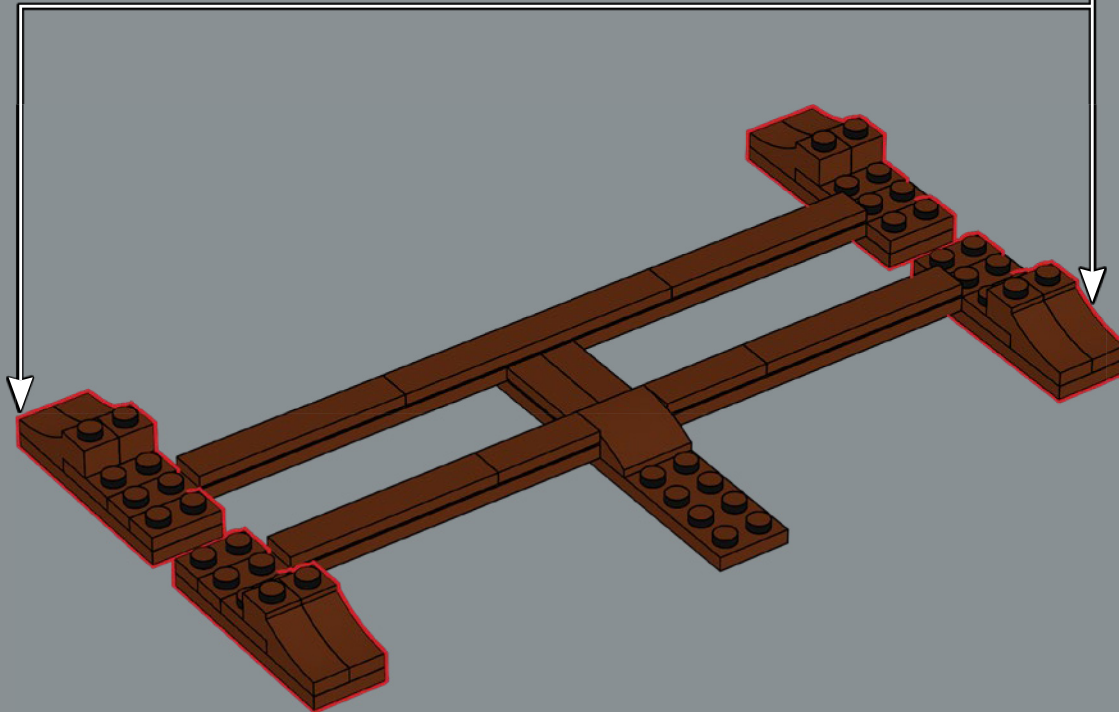
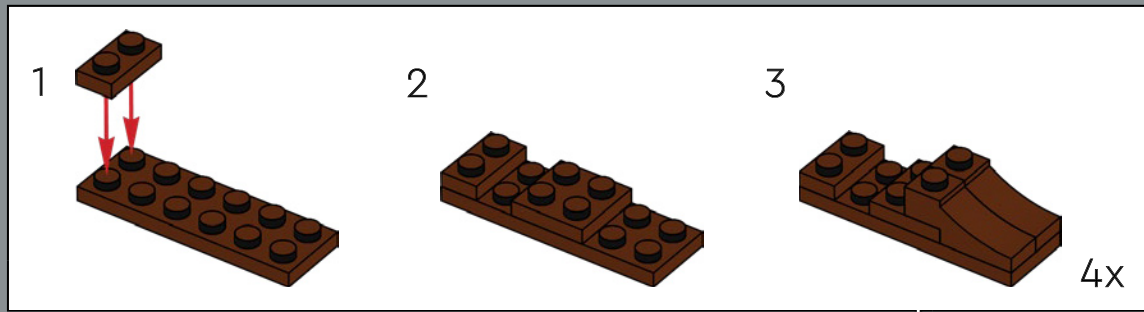

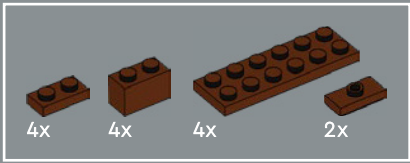

155

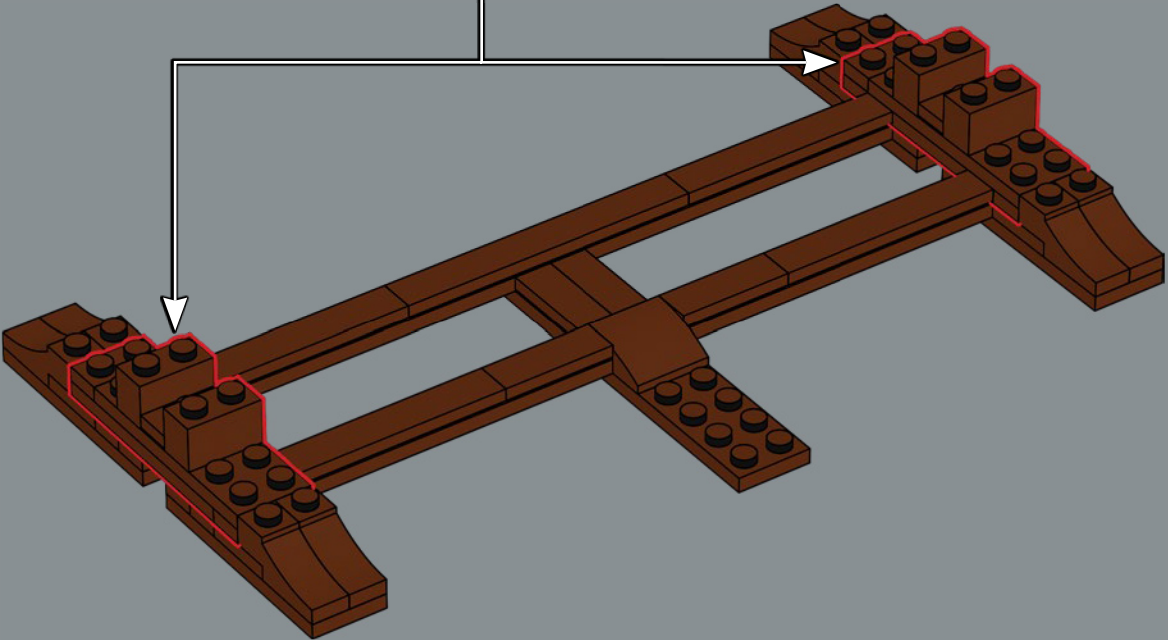
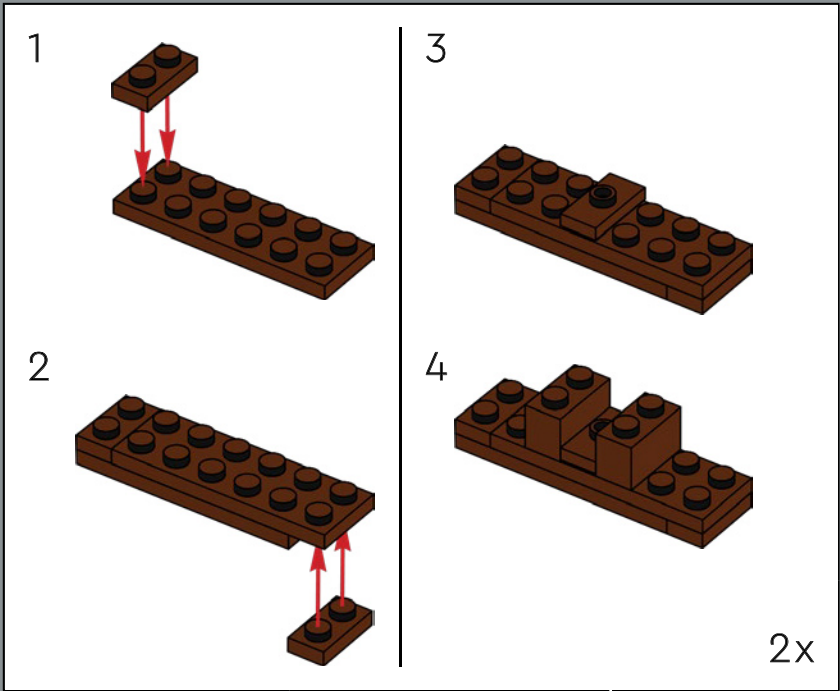



156

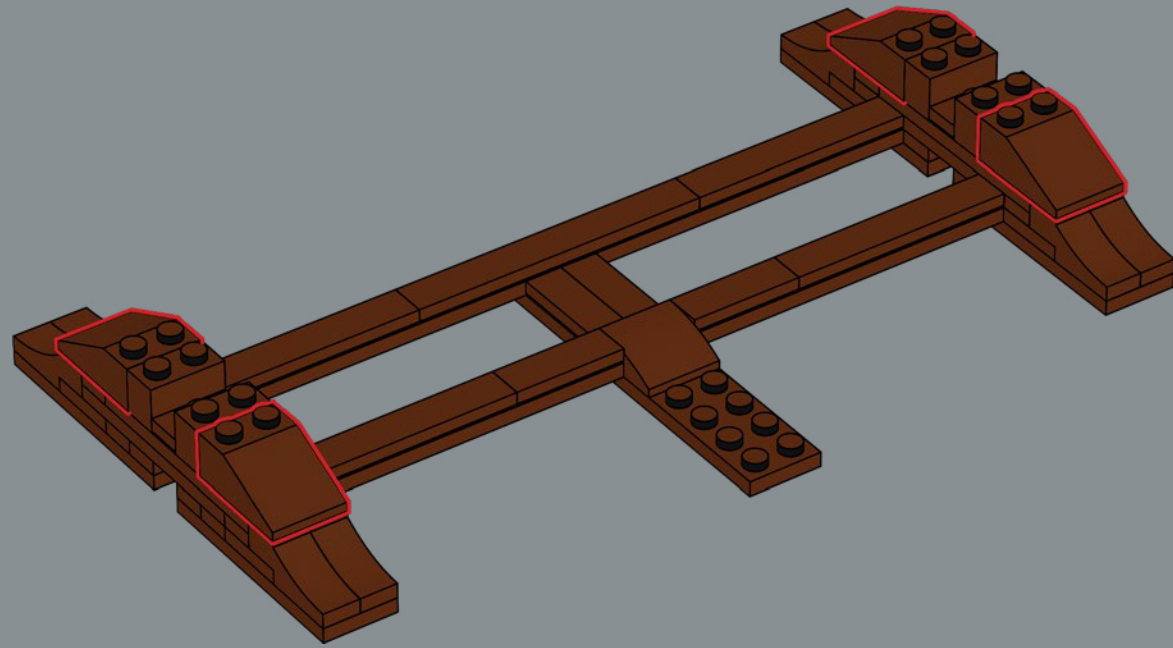

157

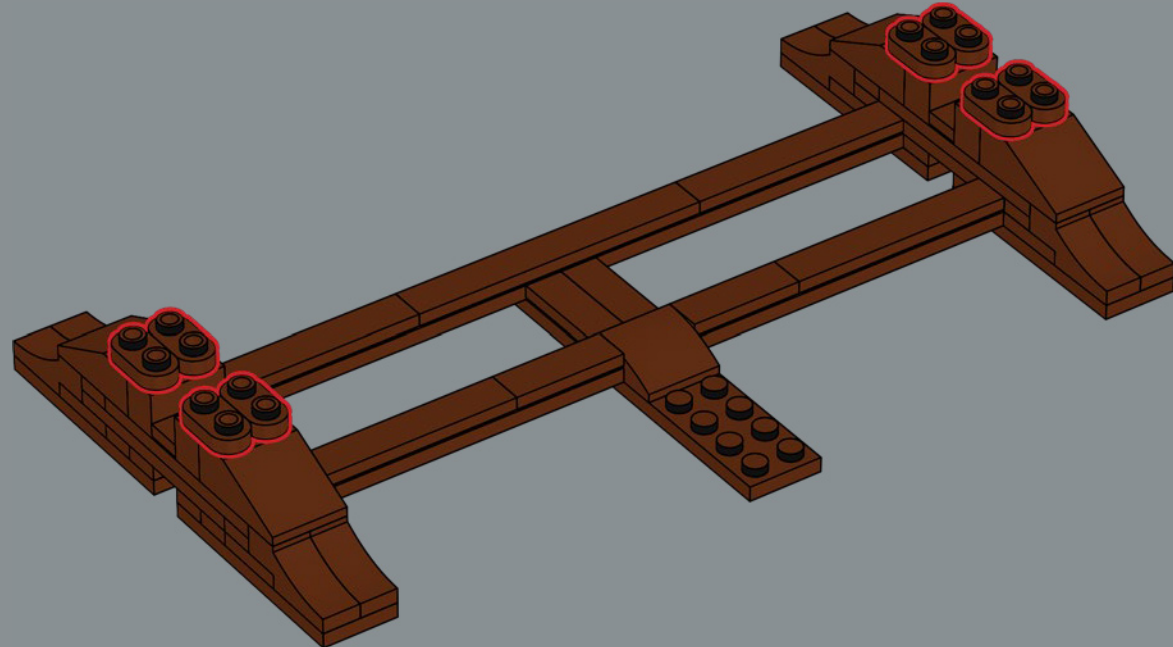

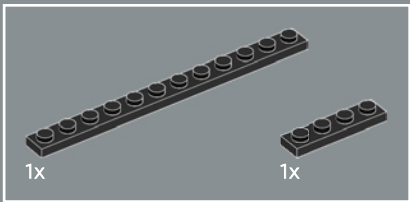
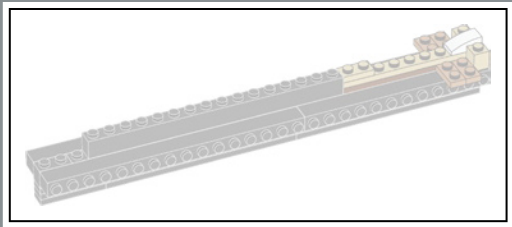

158

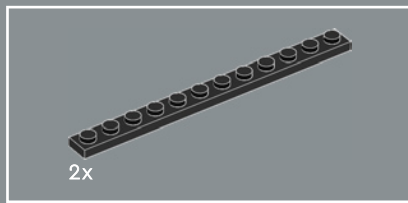
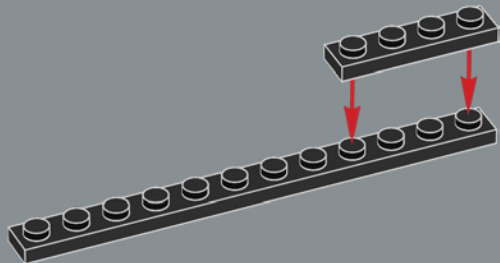

159

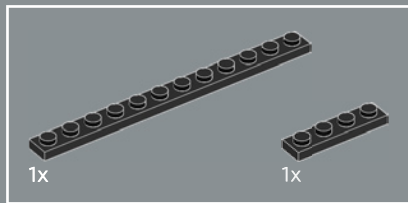
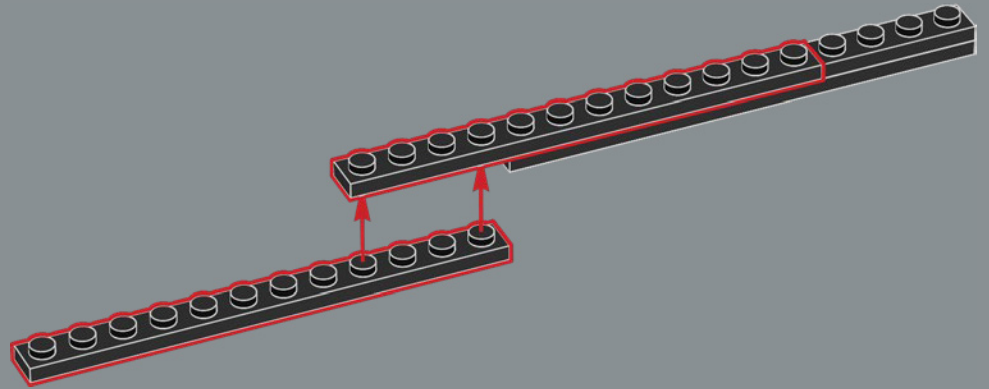

160

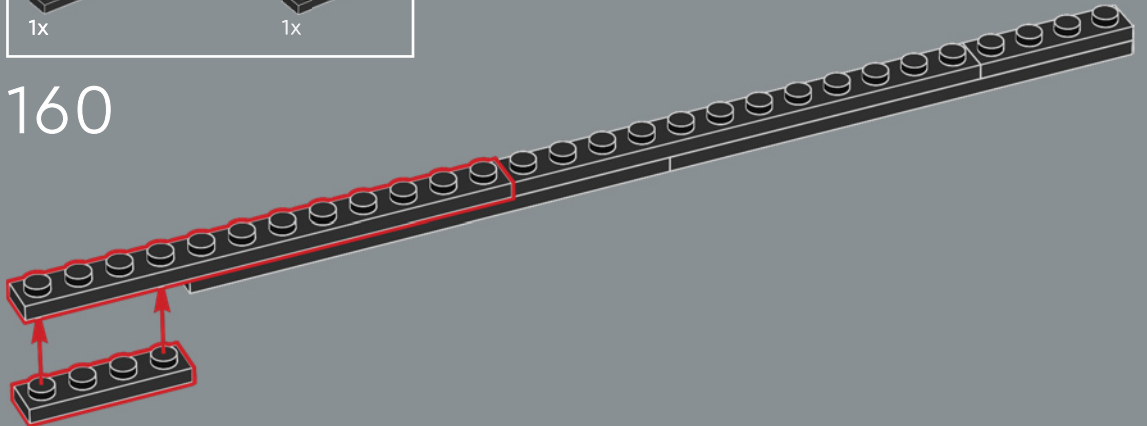

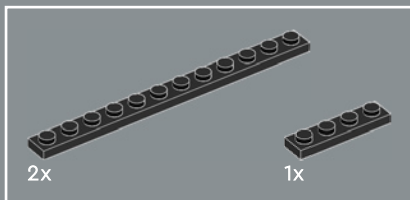

161

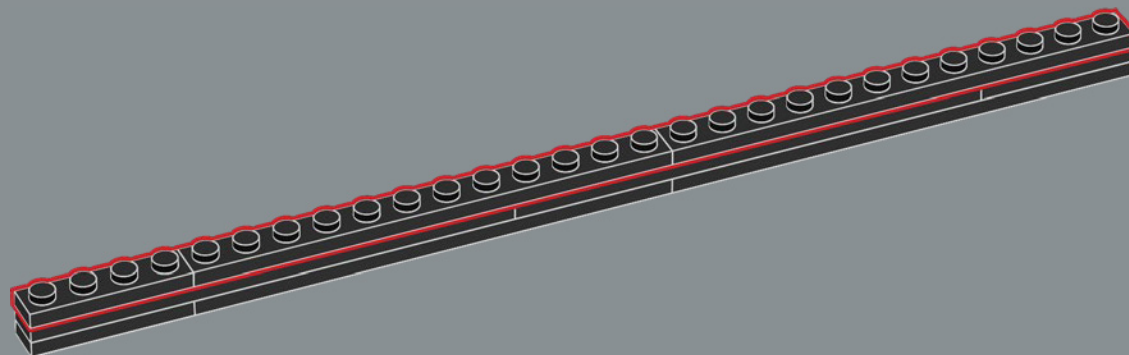

162

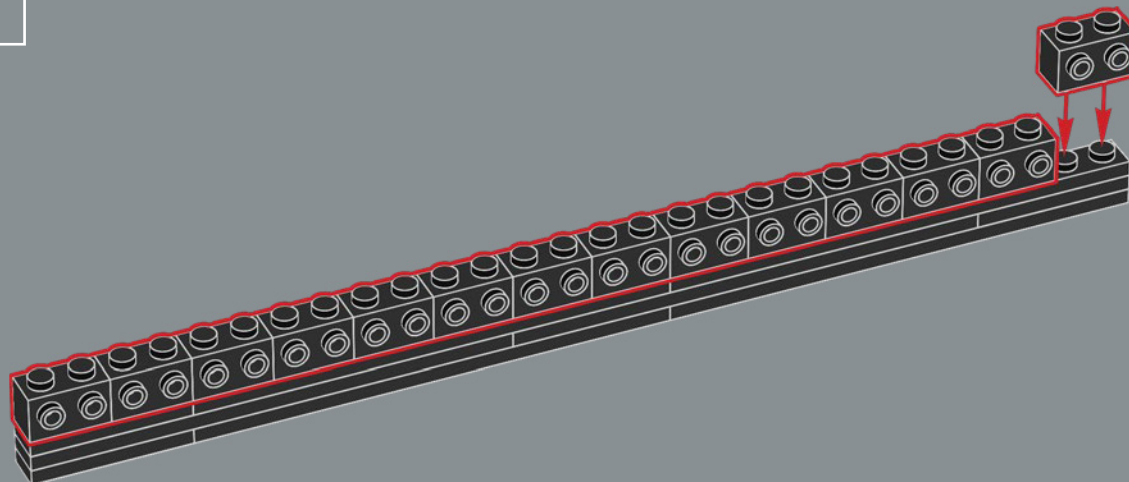

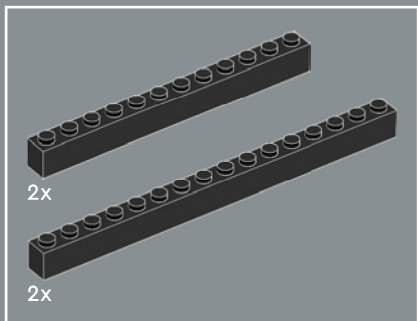

163

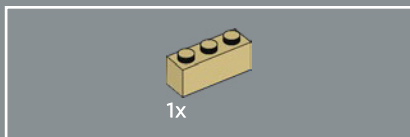
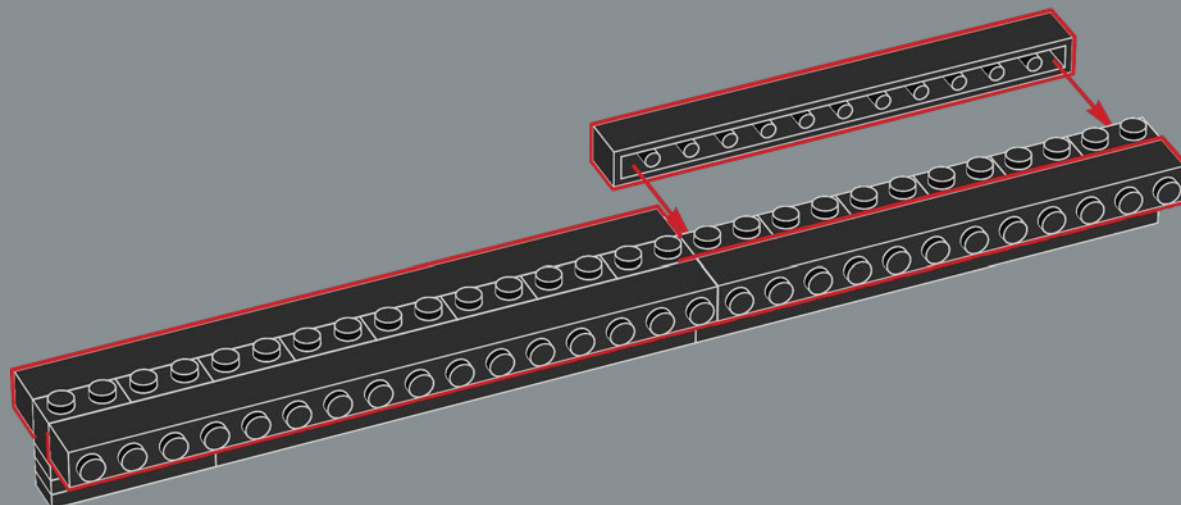

164

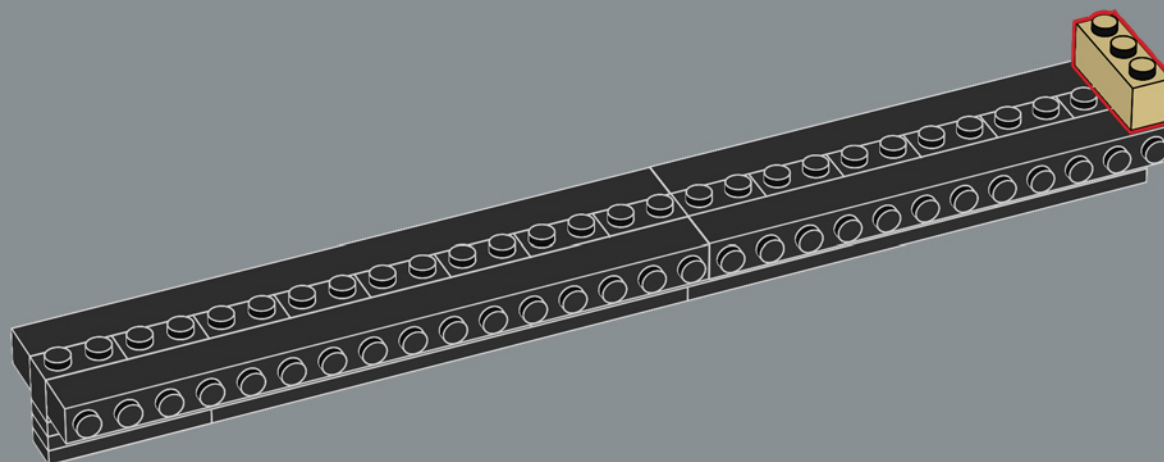

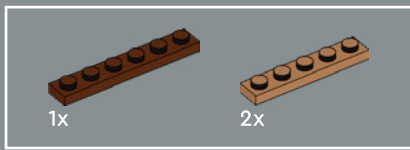

165

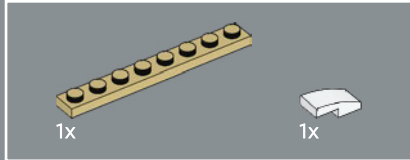
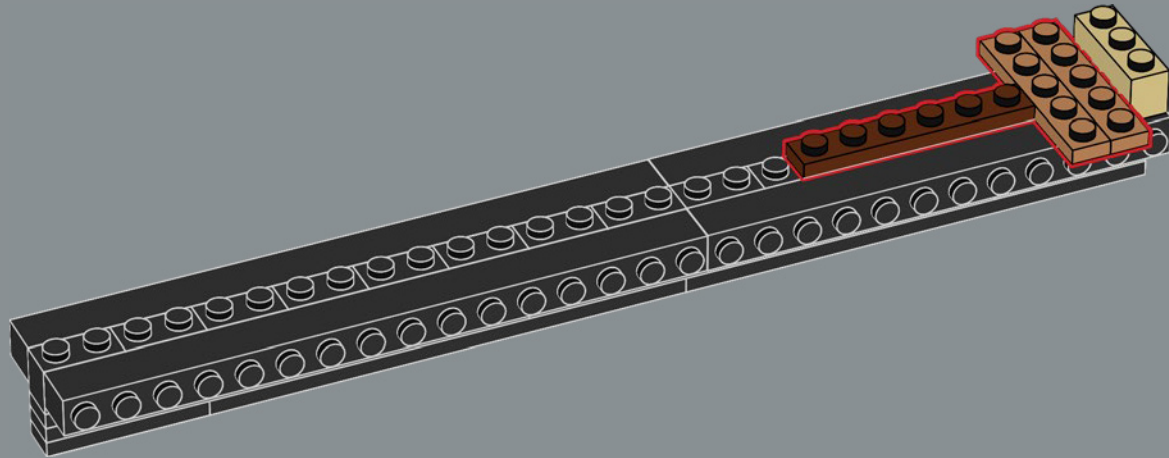

166

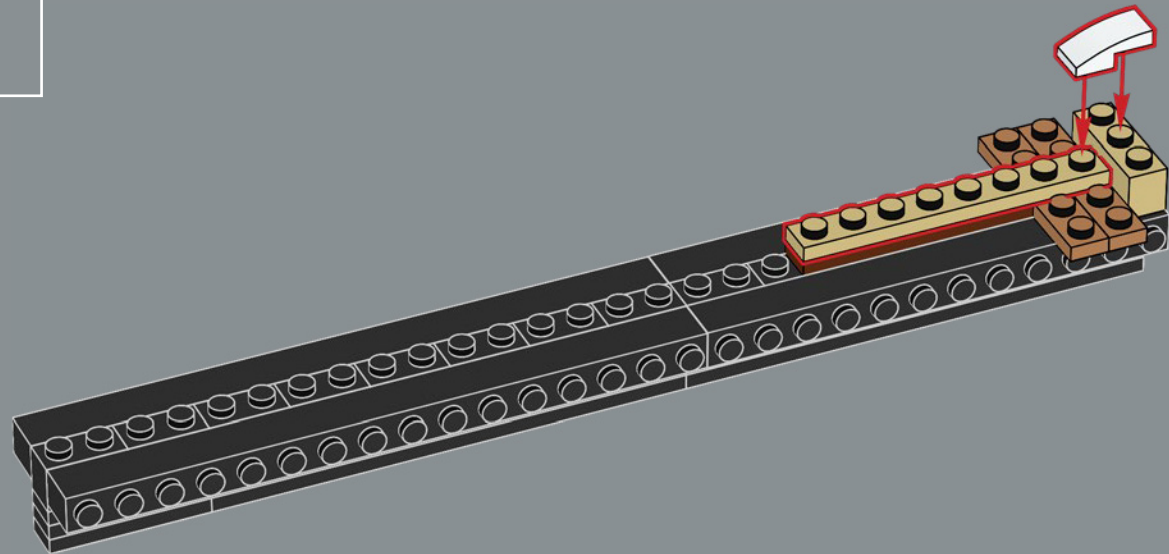

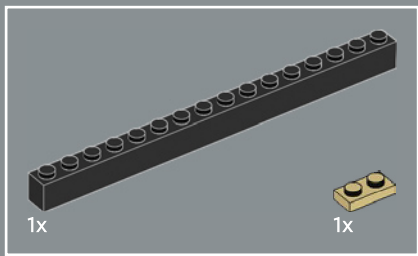

167

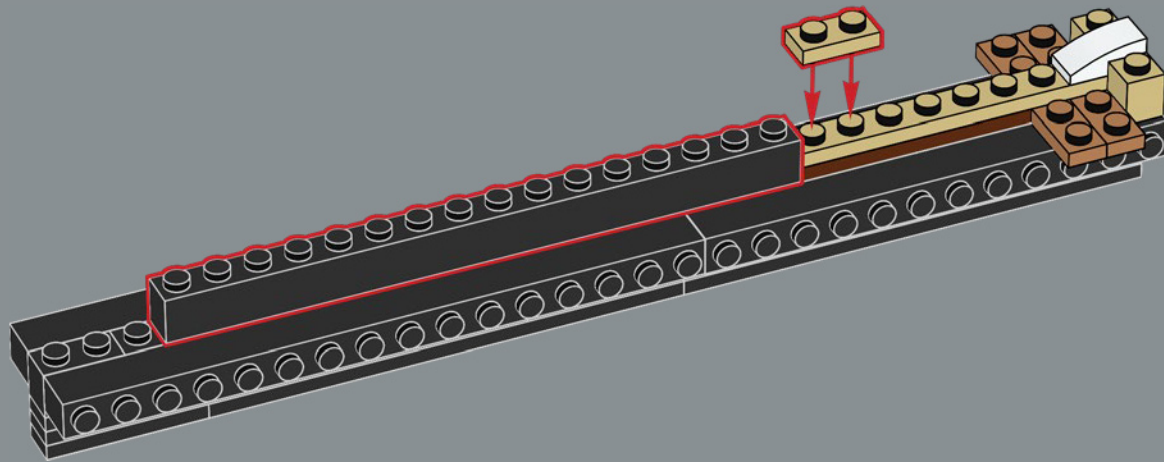

168

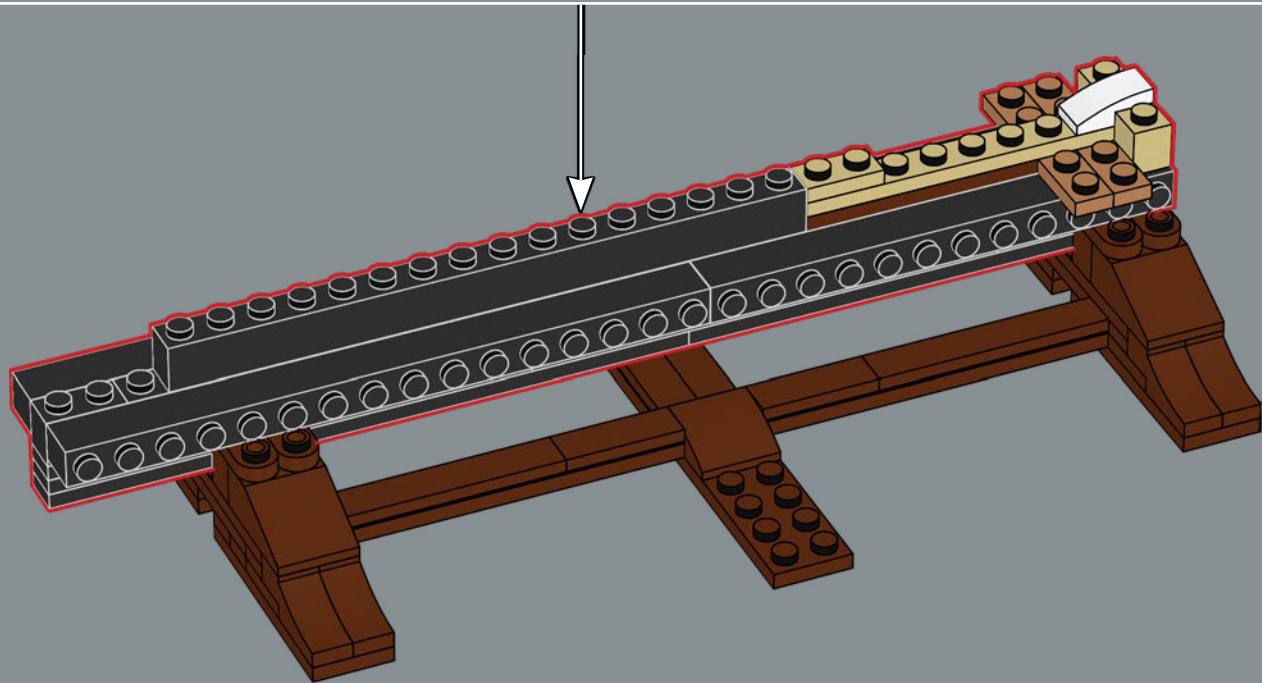



169

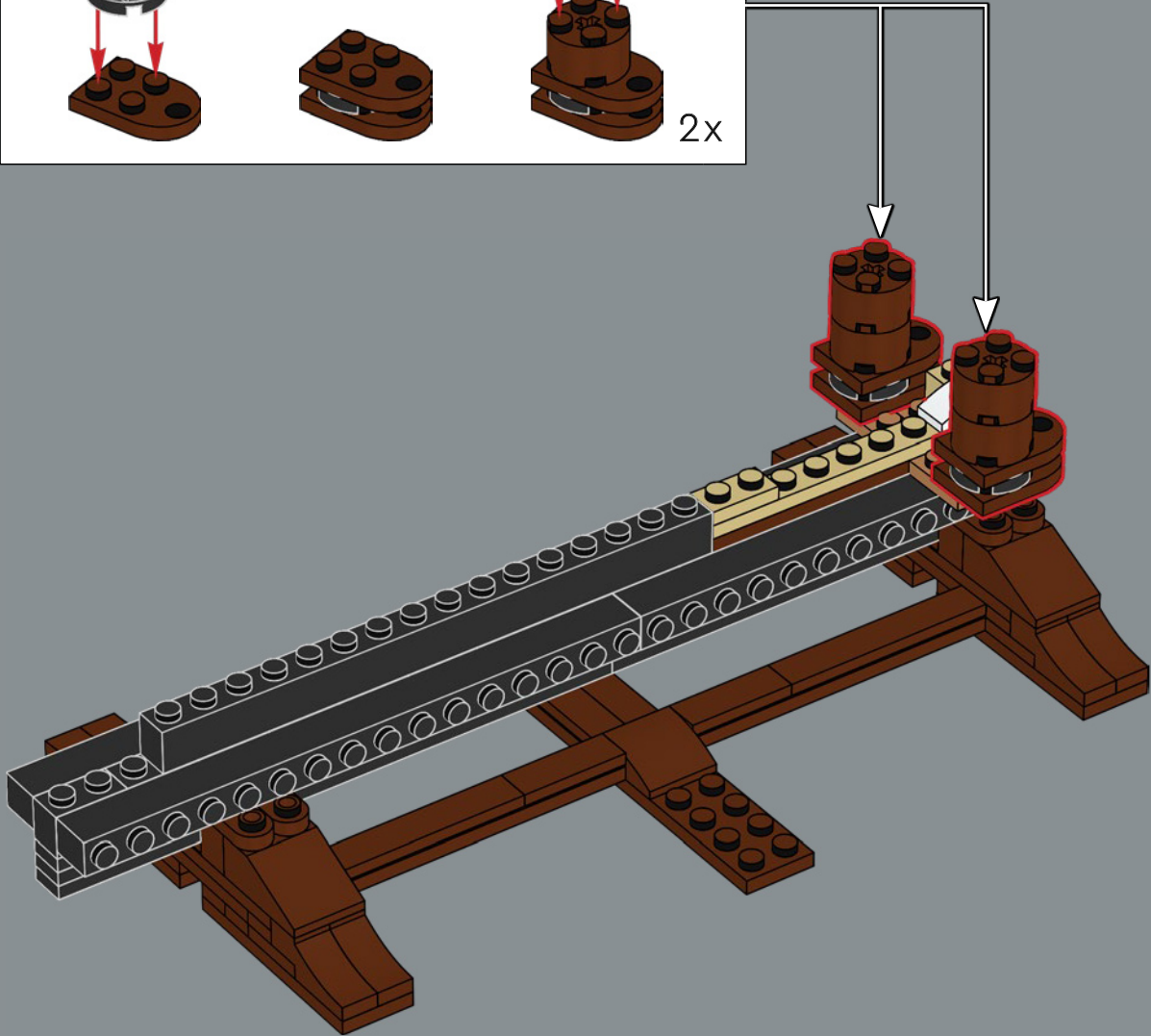
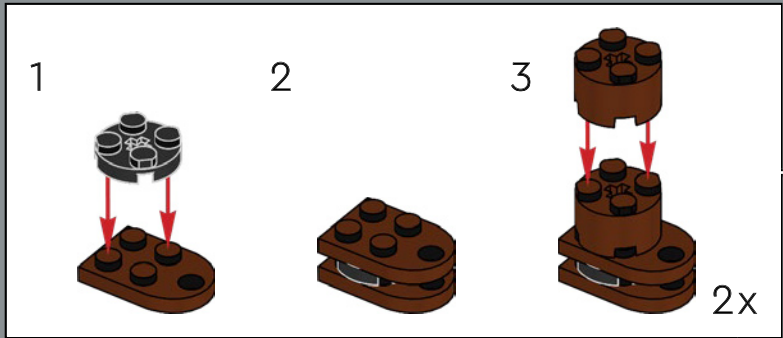

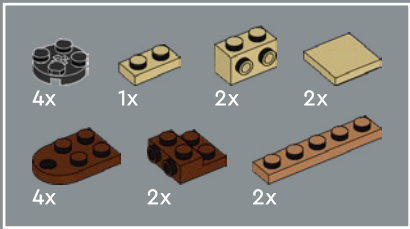

170

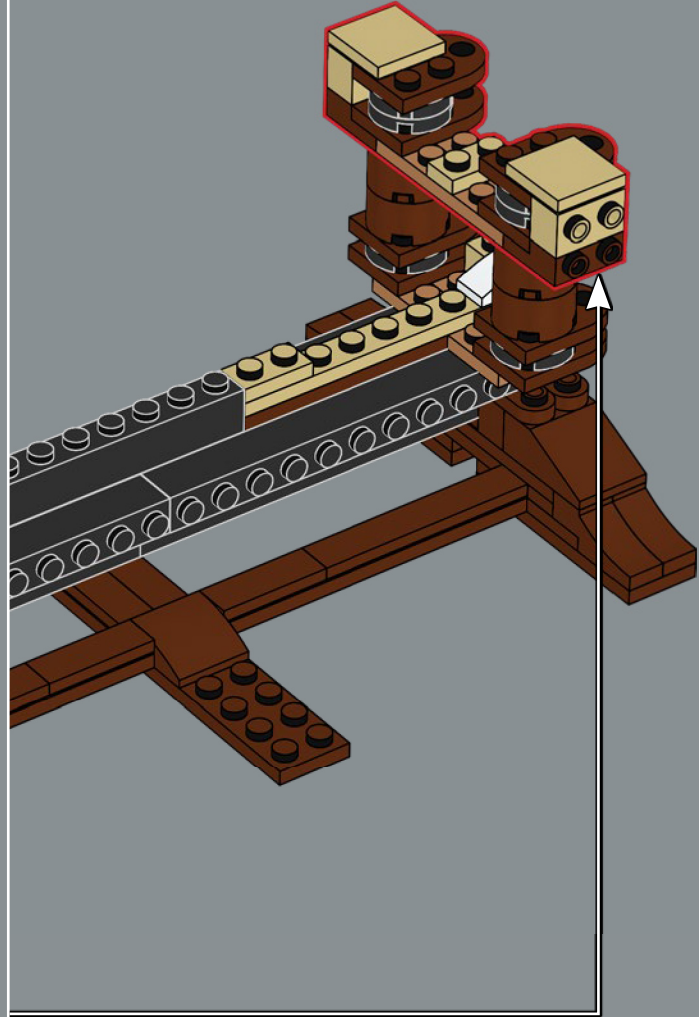
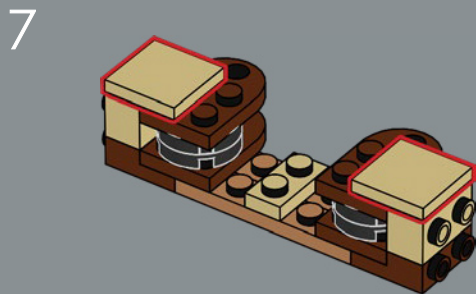
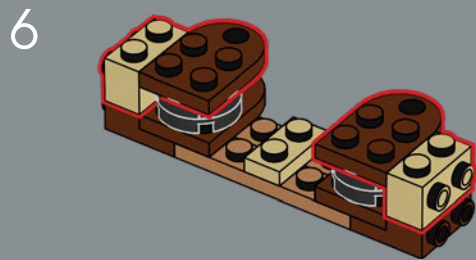
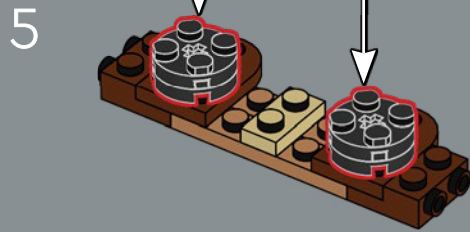
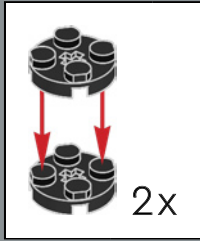
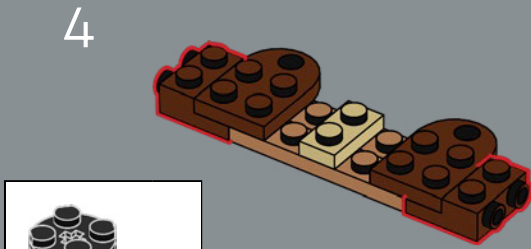
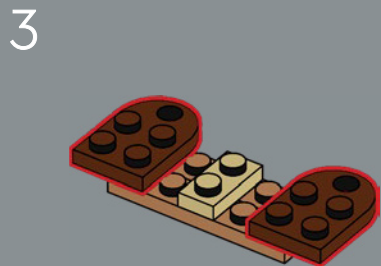
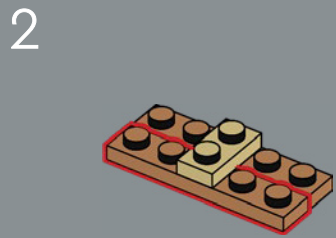
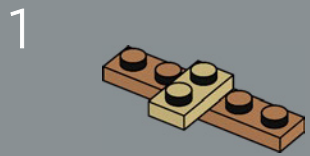

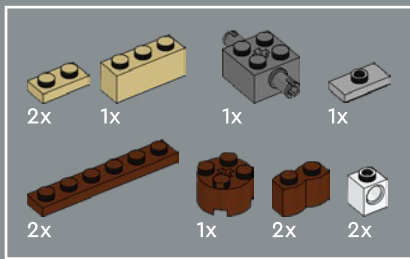

171

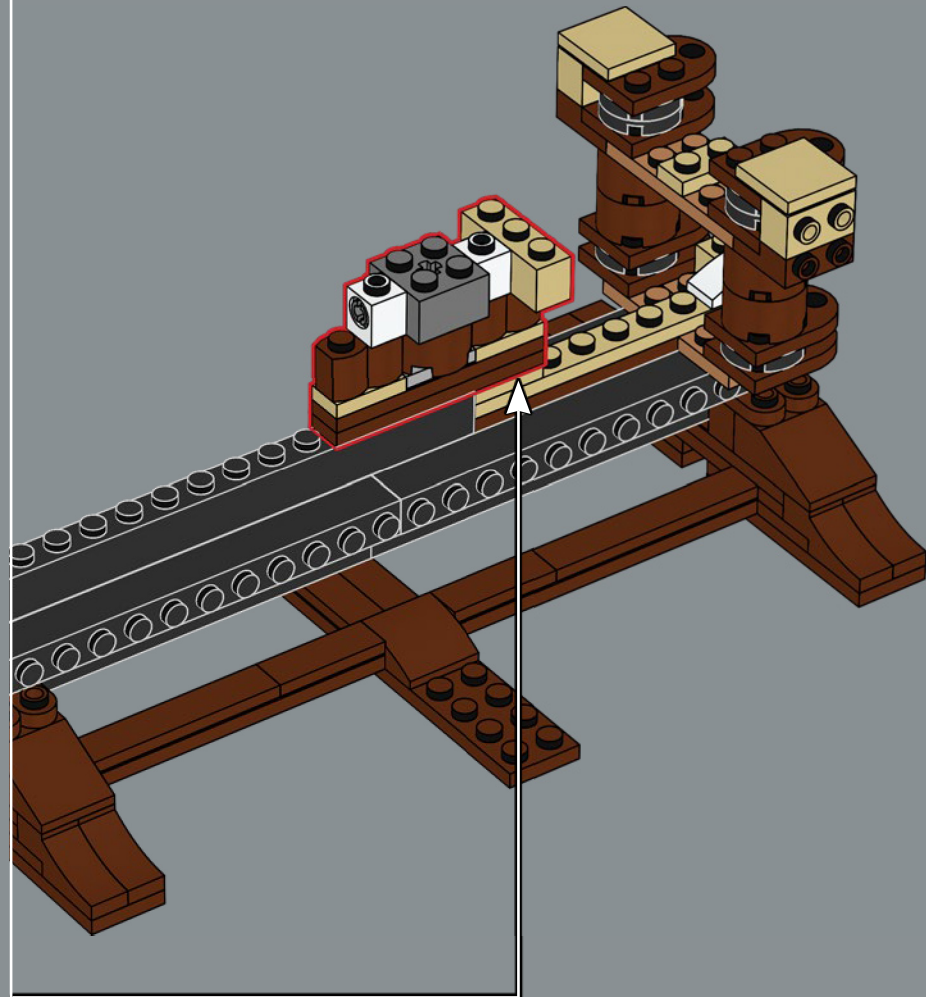
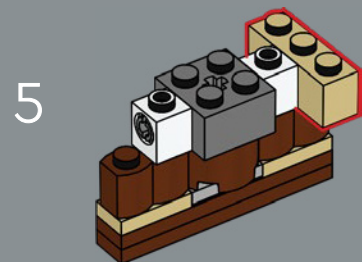
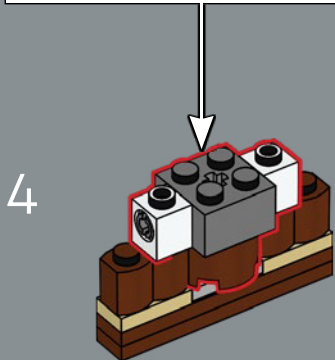
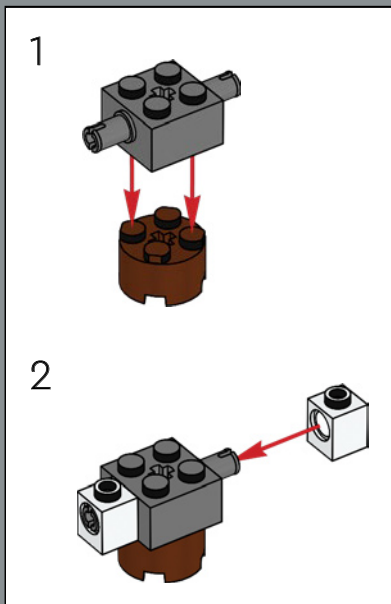
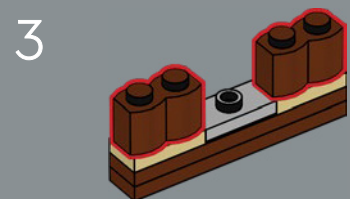
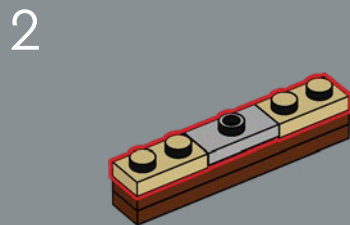
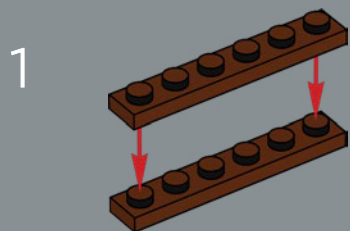

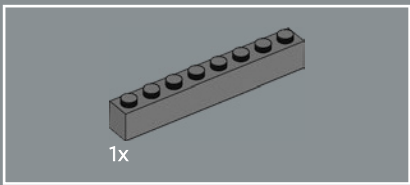

172

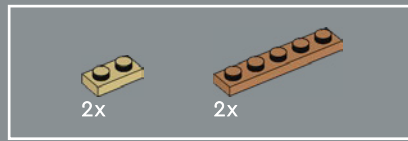
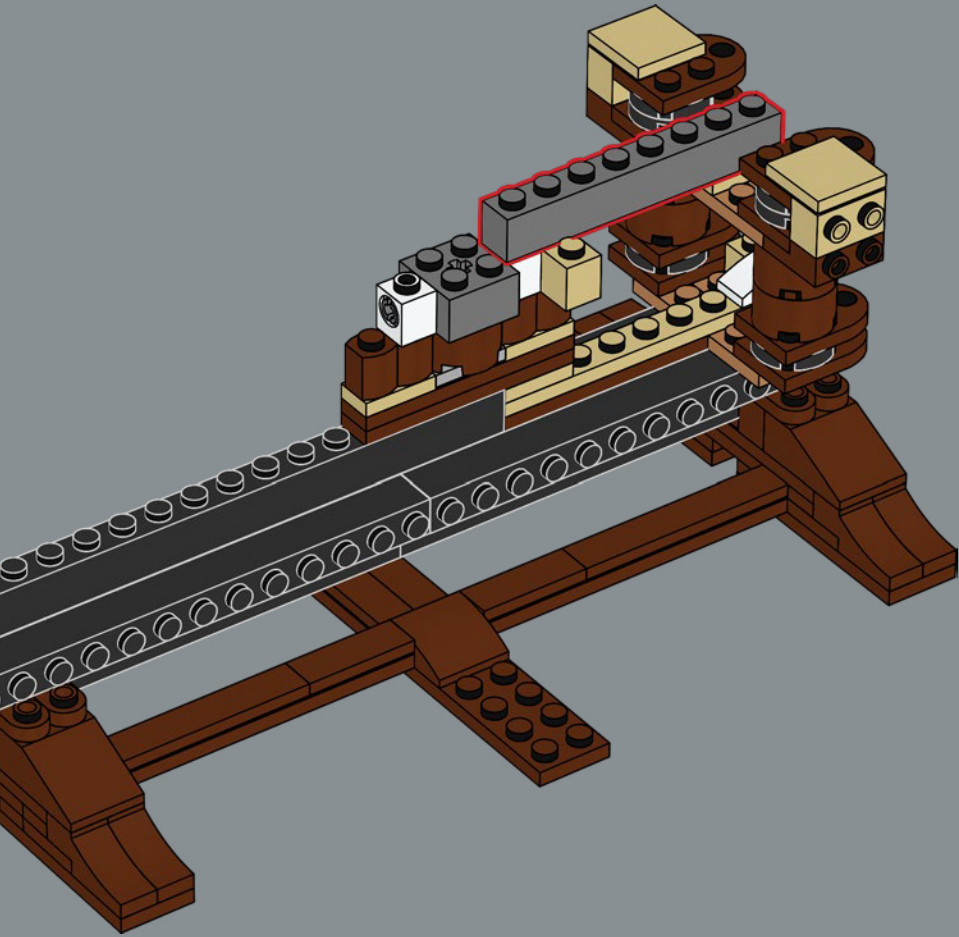

173

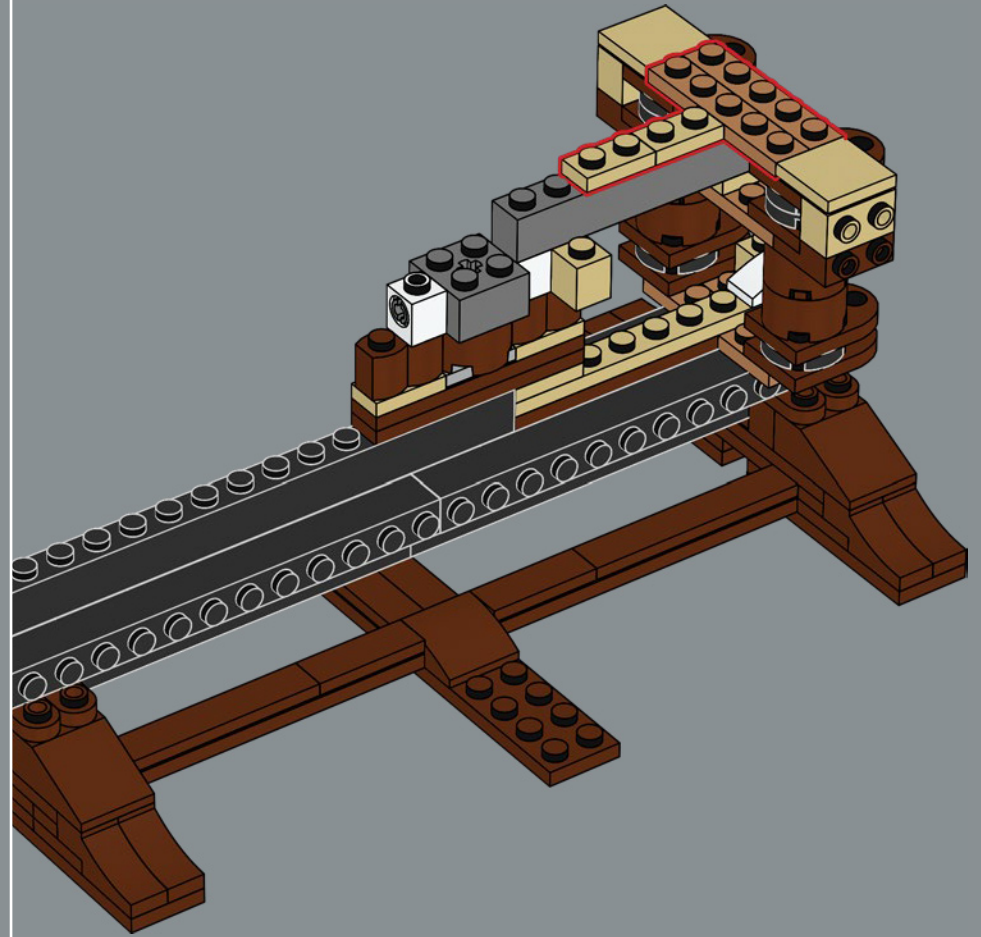

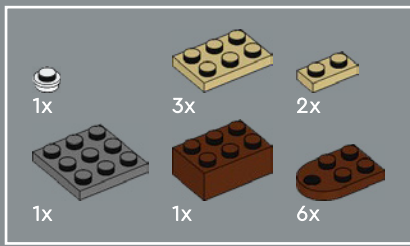

174

1

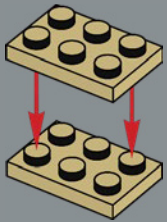

2

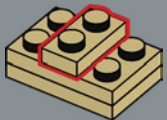

3



4

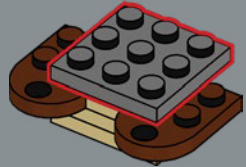

5

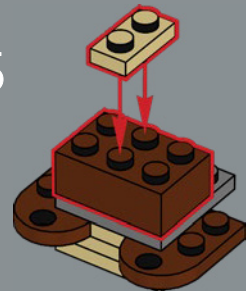

6

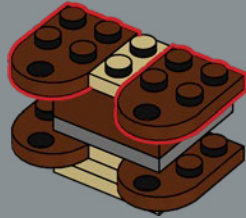

7

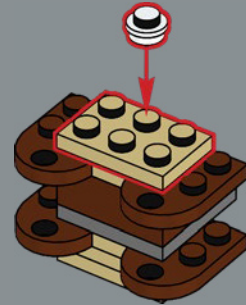

8

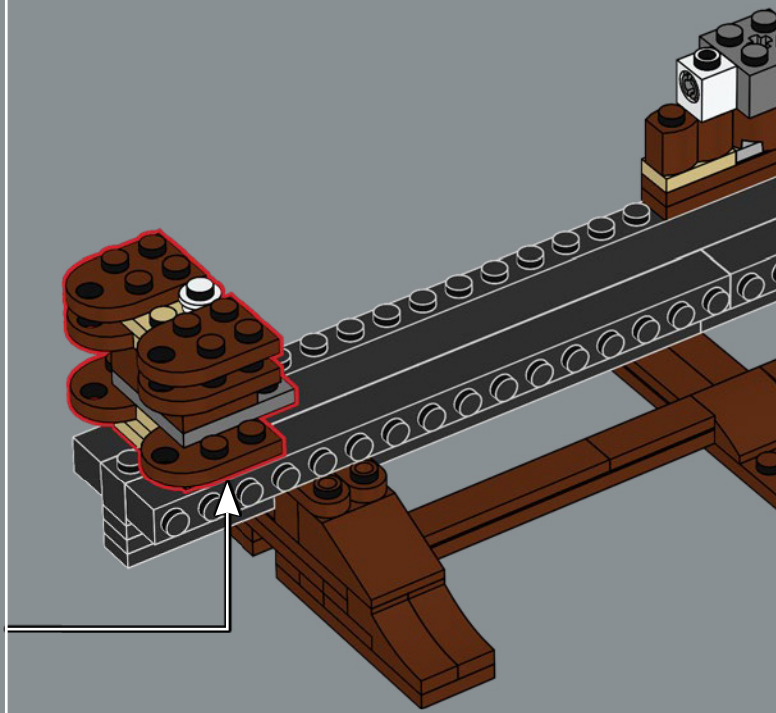
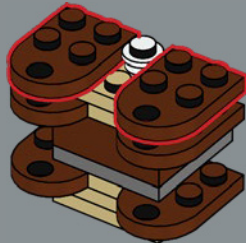

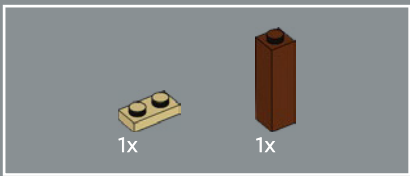

175

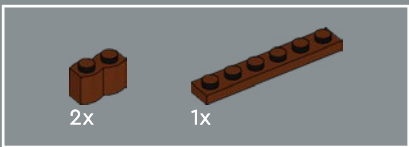
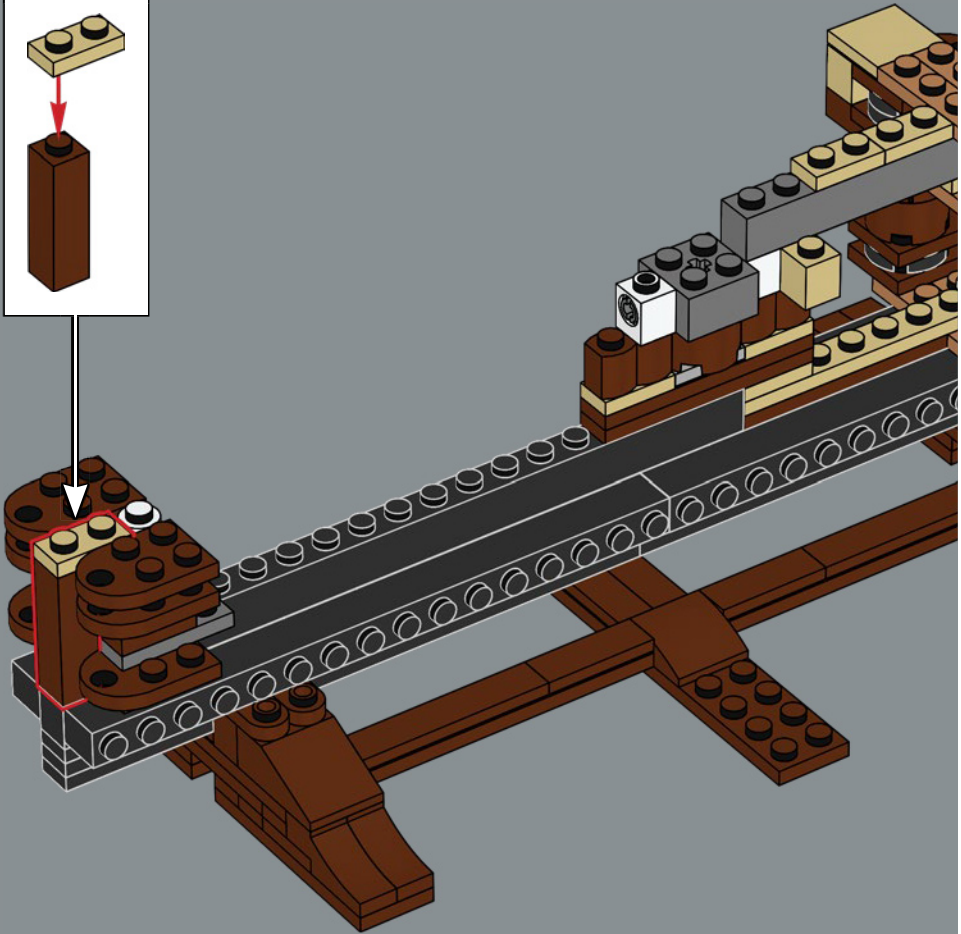
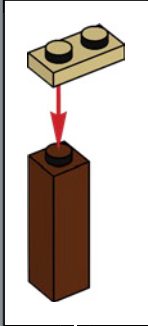

176

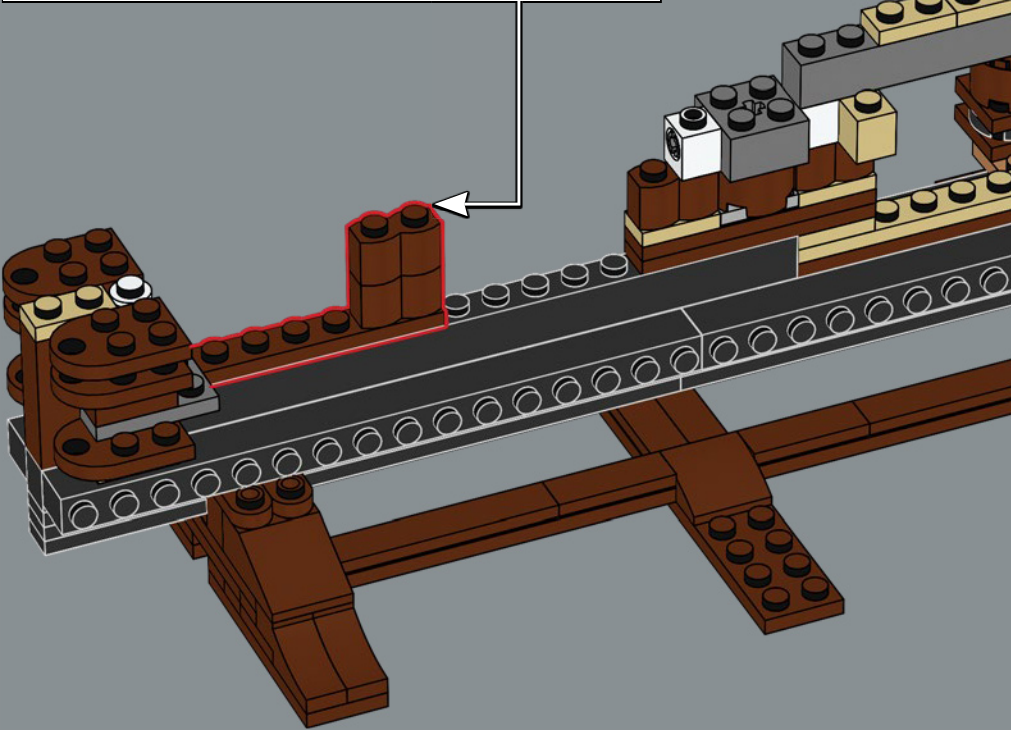
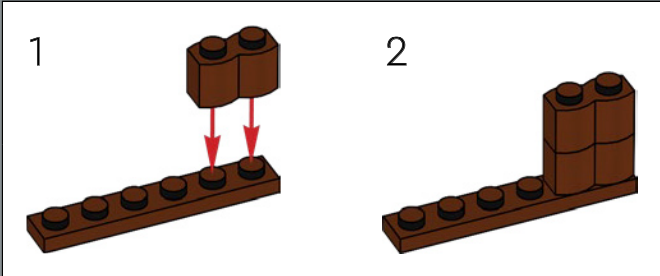

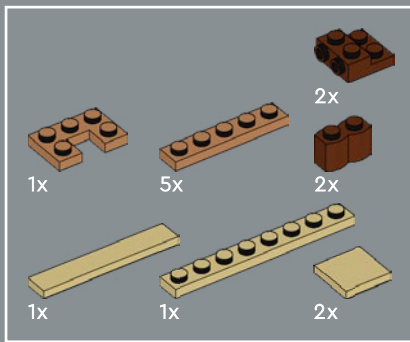

177

1

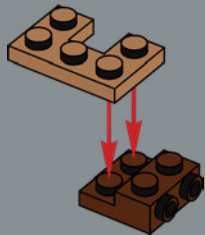

2

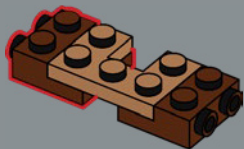

3

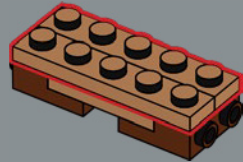

4

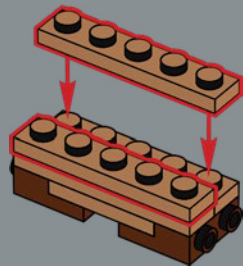

5

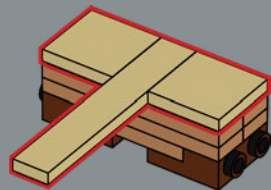

6

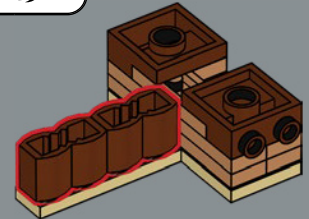

7

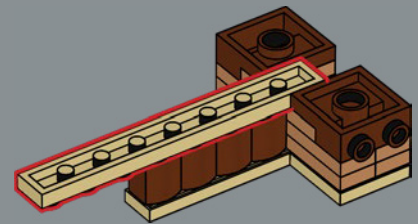

8

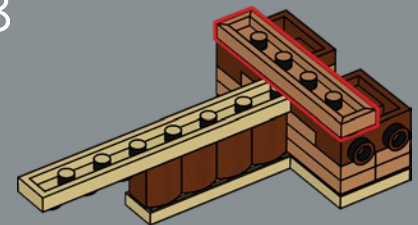

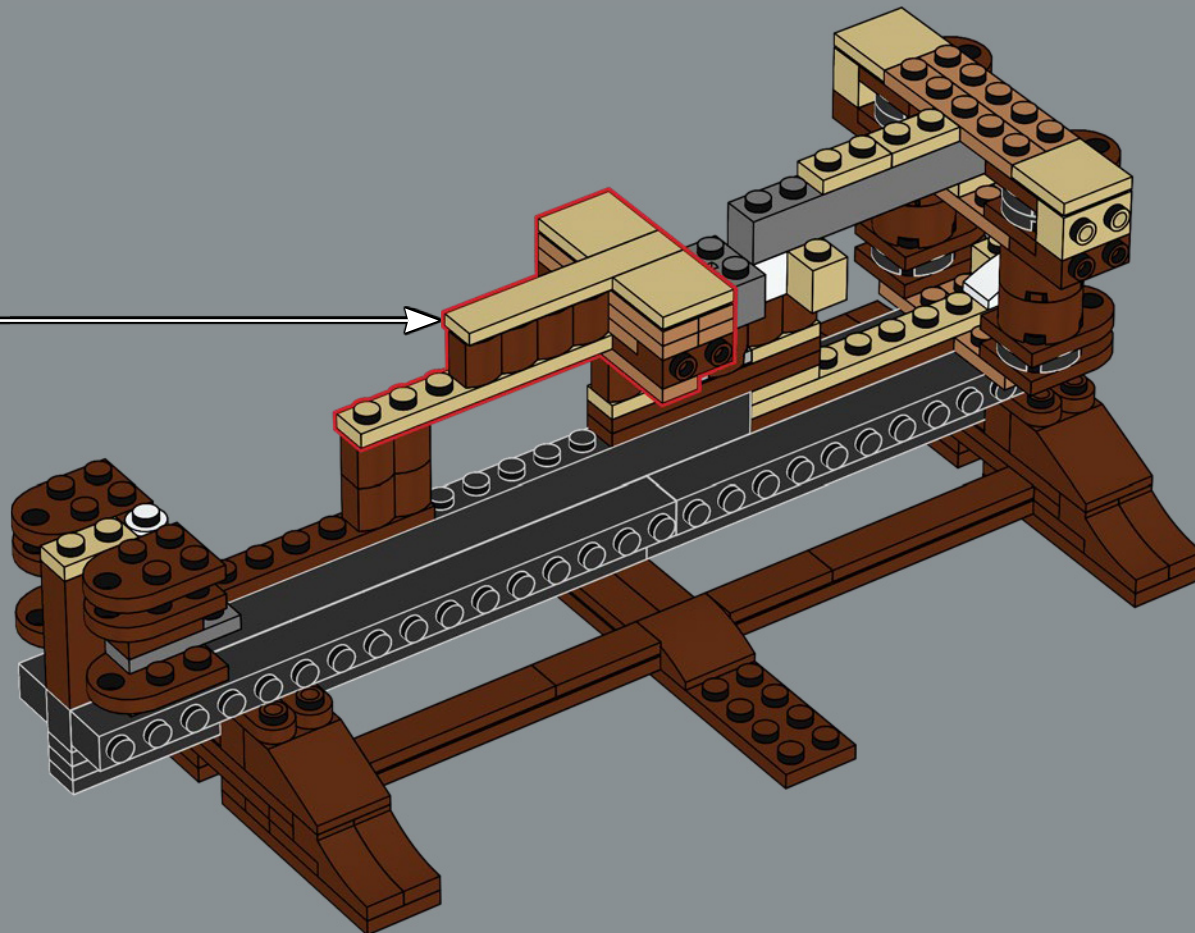

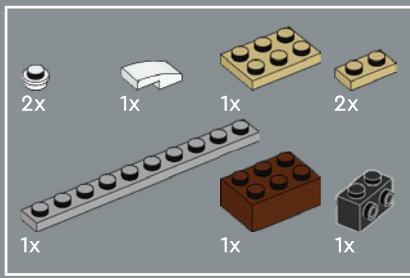

178

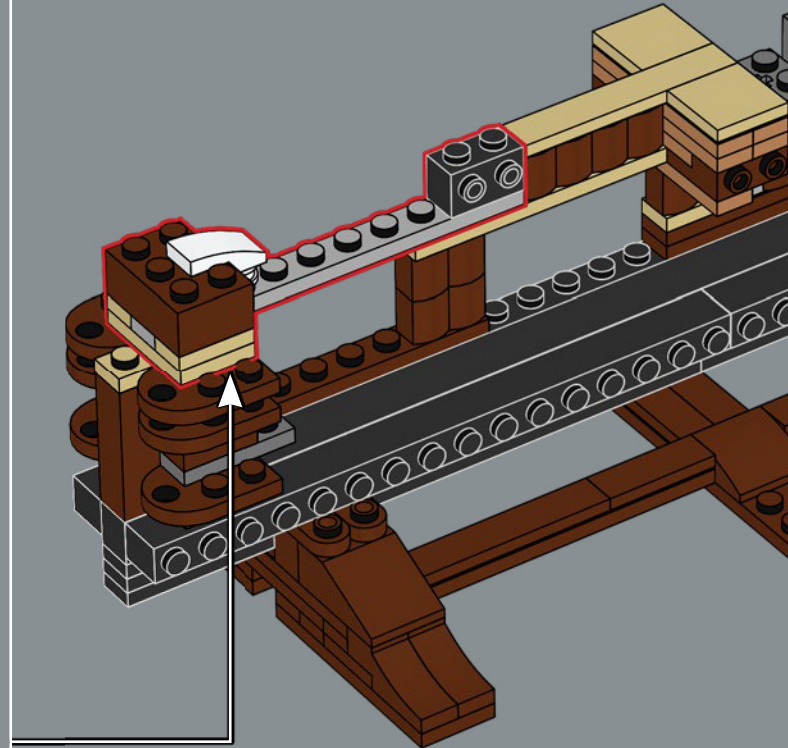
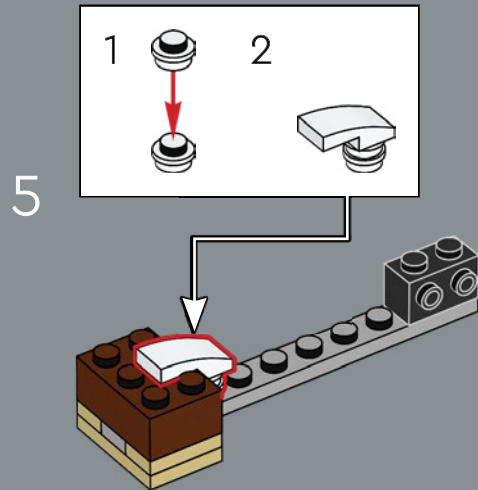
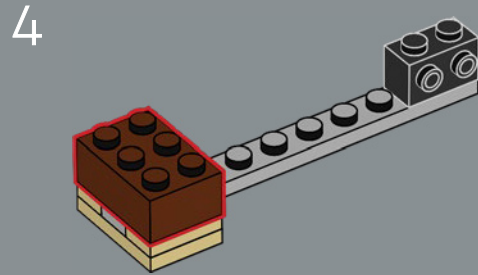
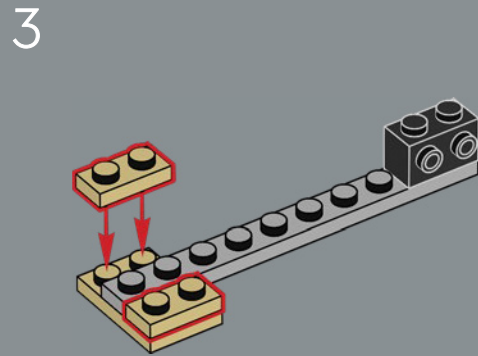
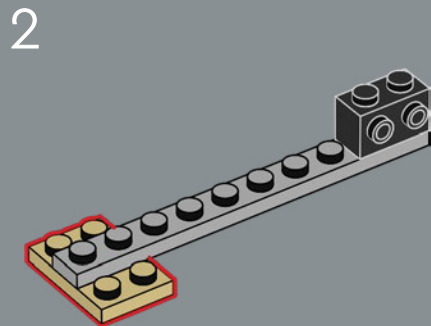
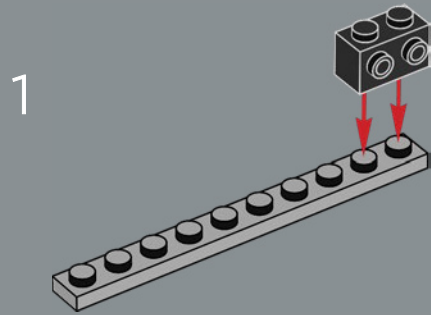

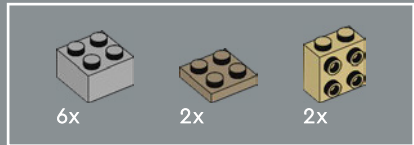

179

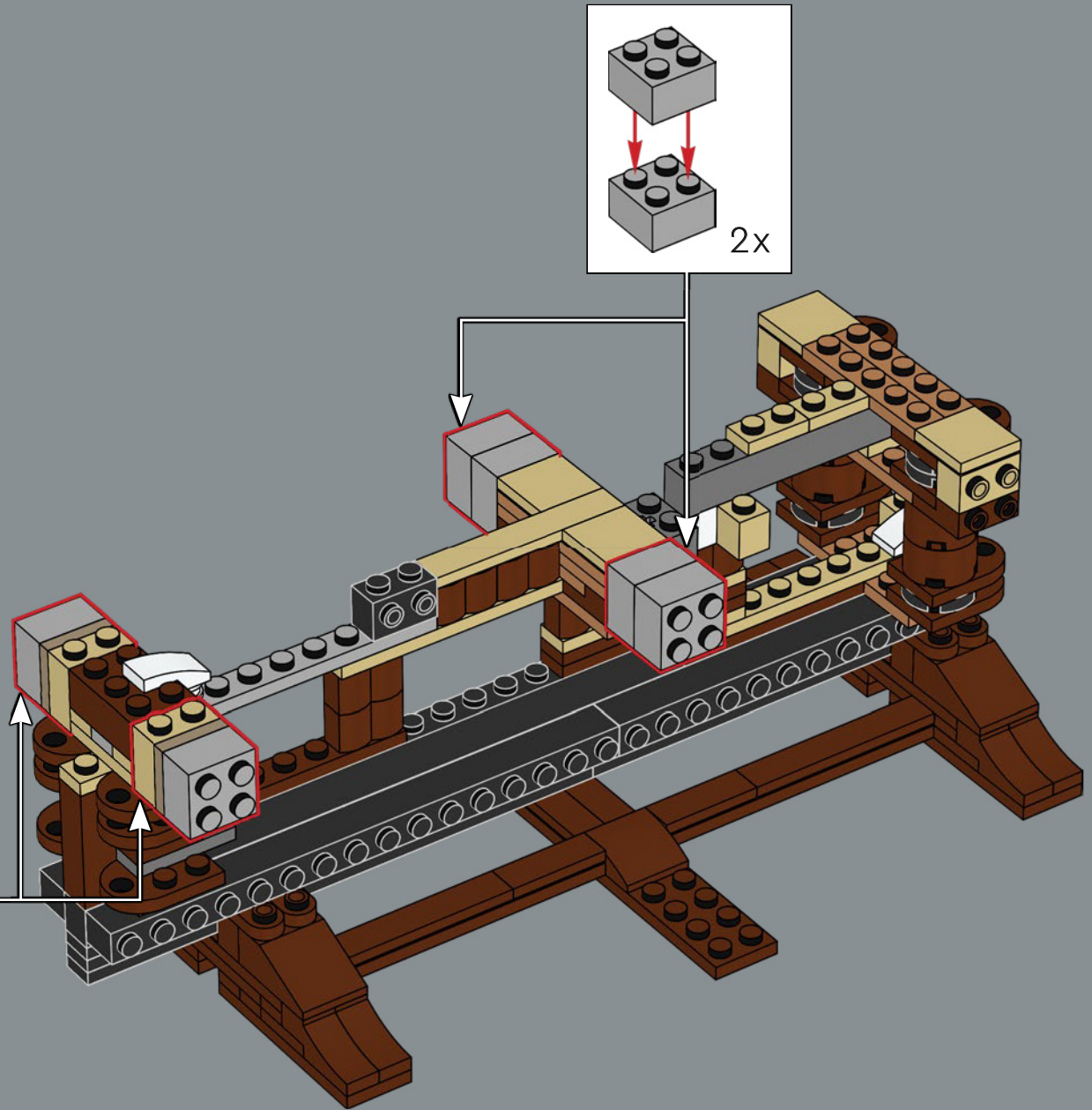
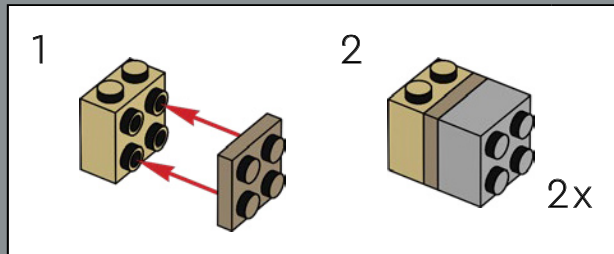
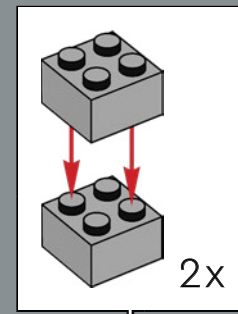

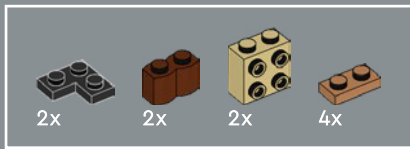

180

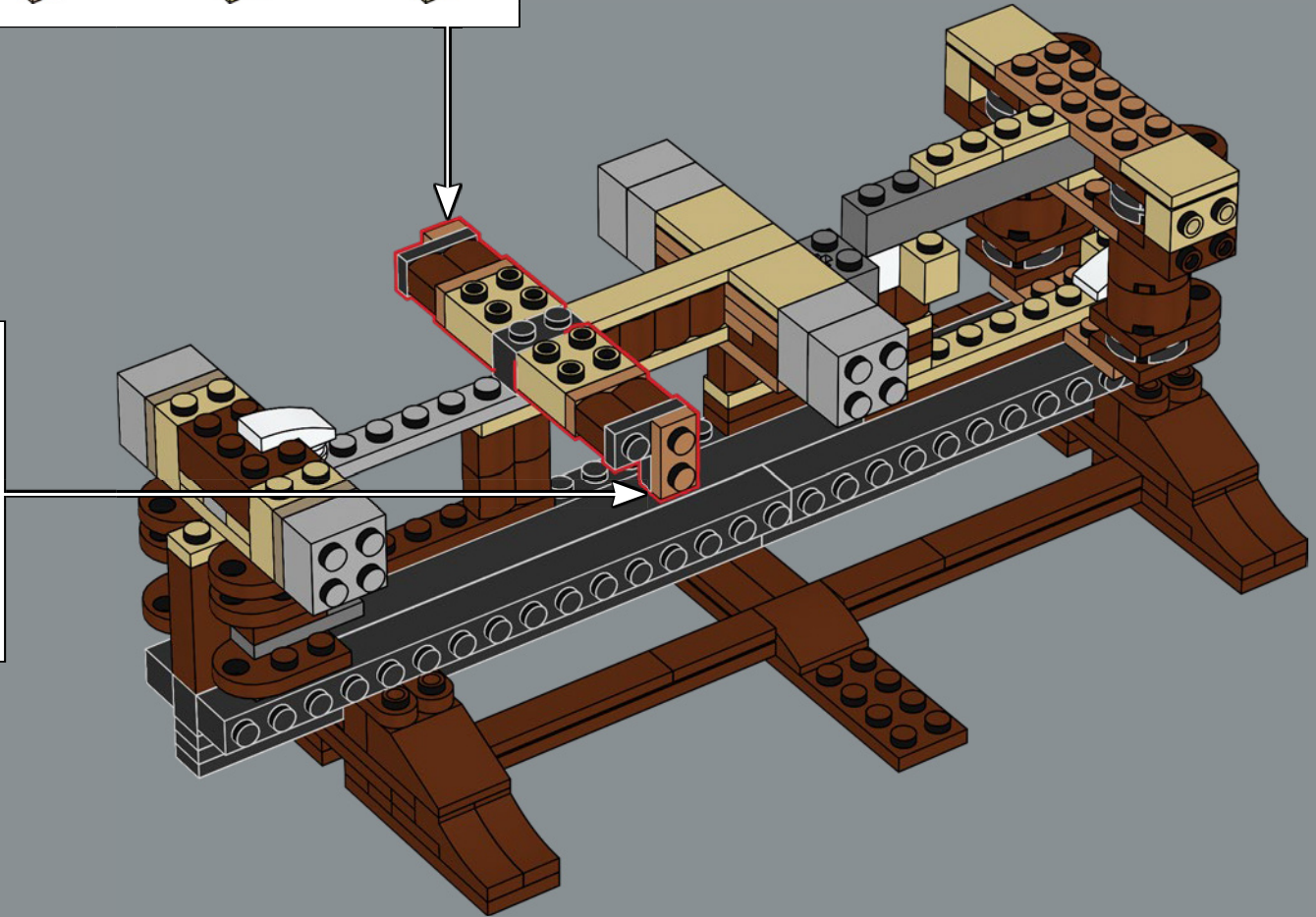
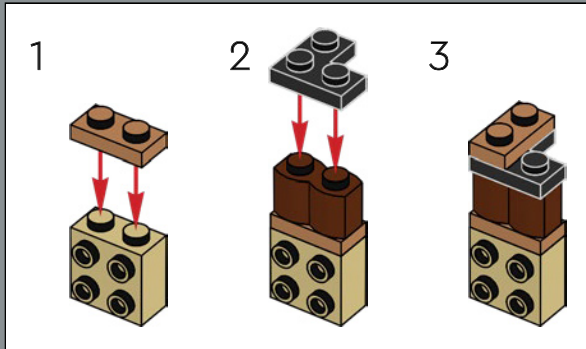
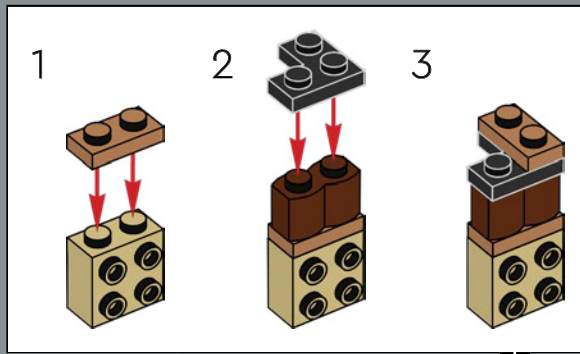

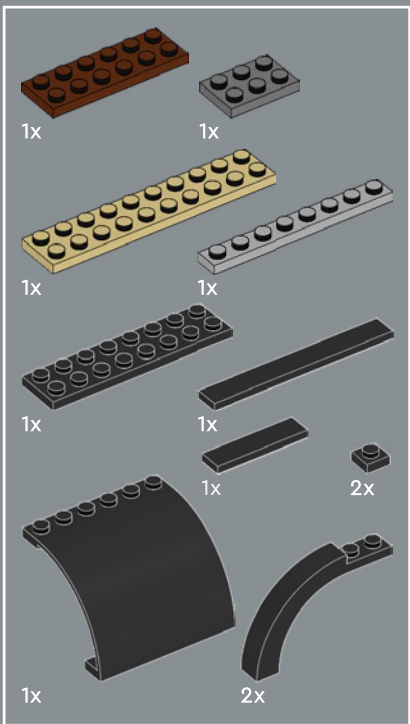

181

1

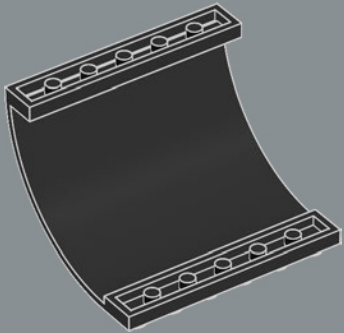

2

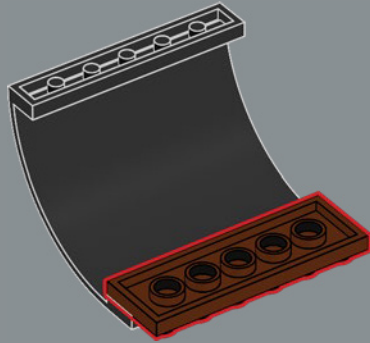

3

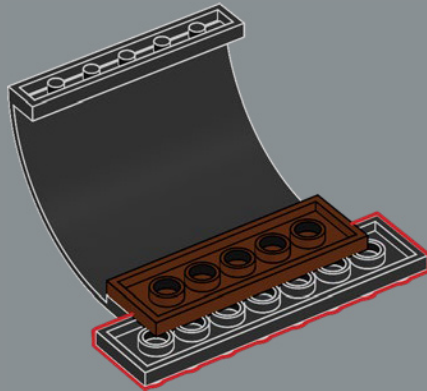

4

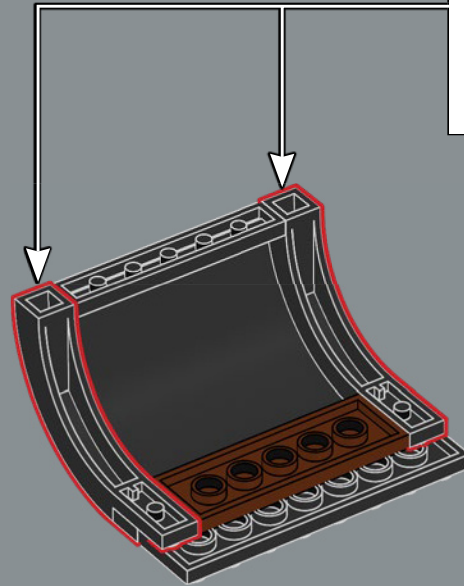

5

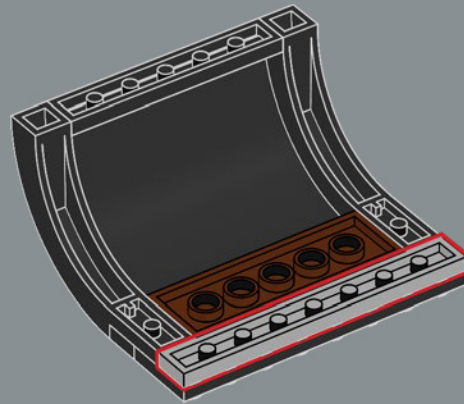

6

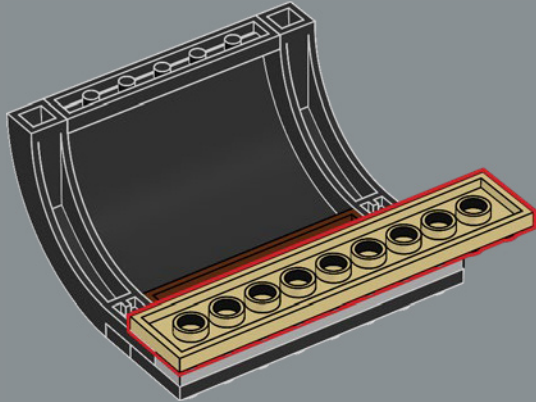

7

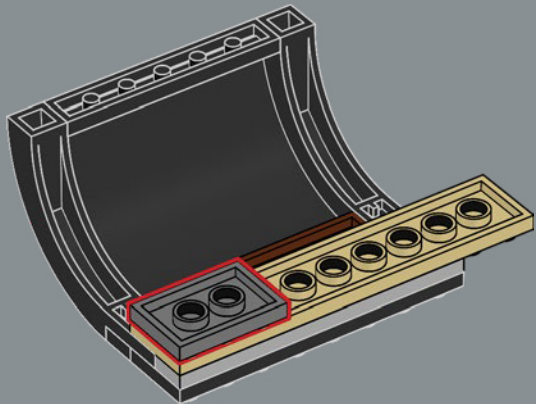

8

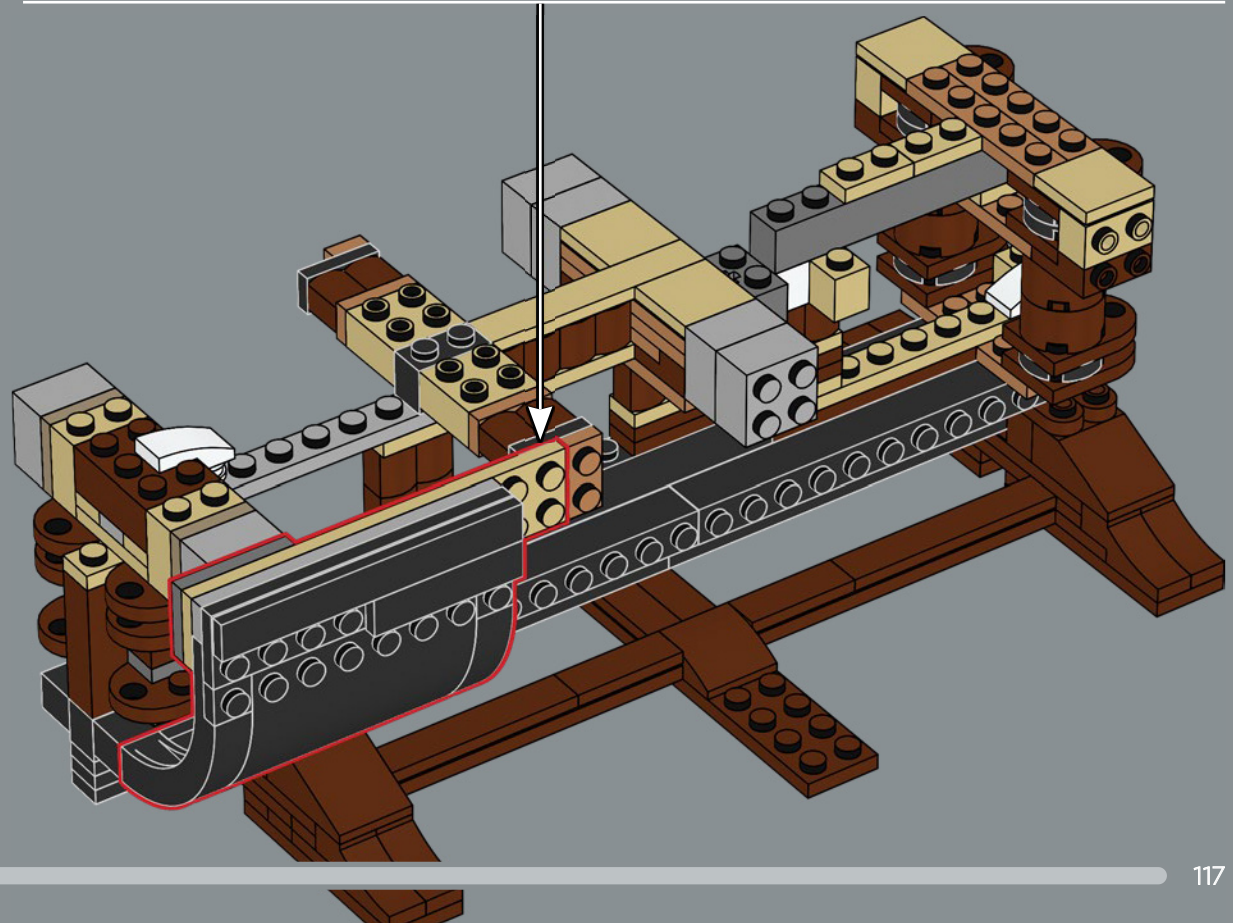
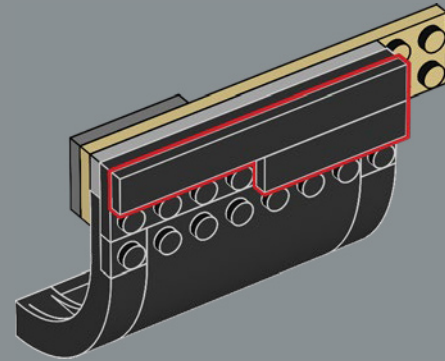

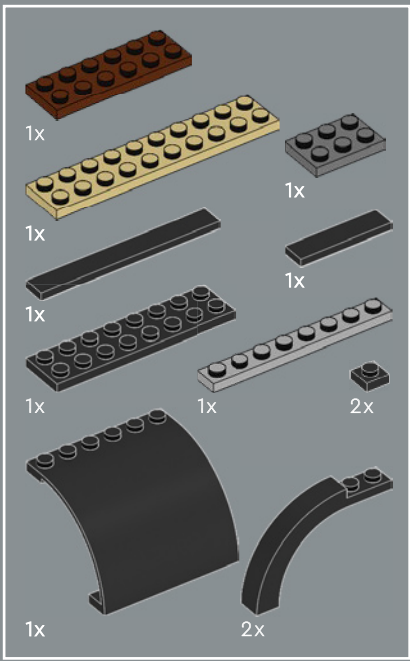

182

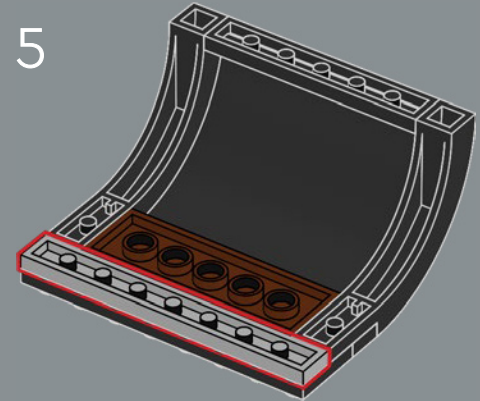
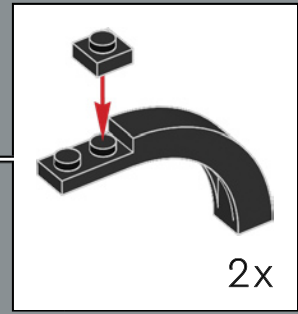
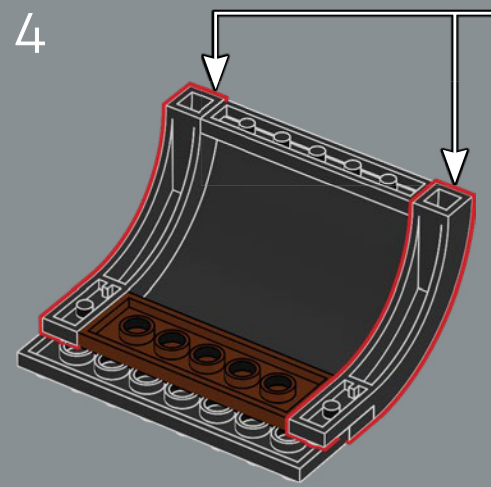
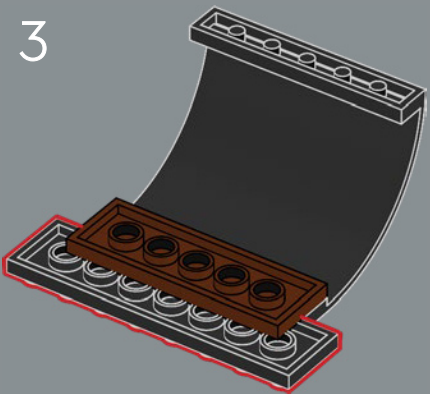
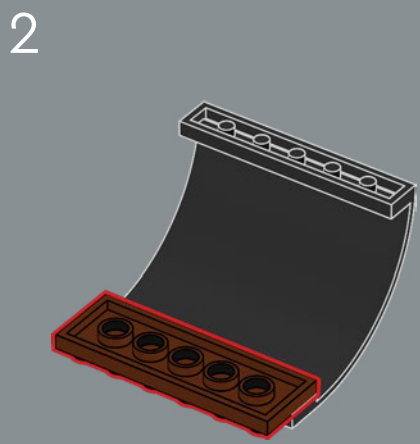
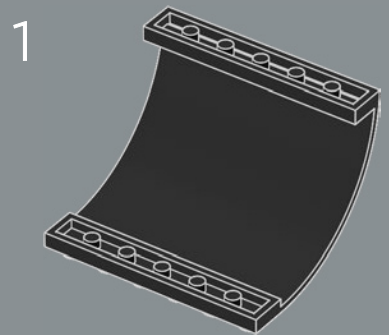

6

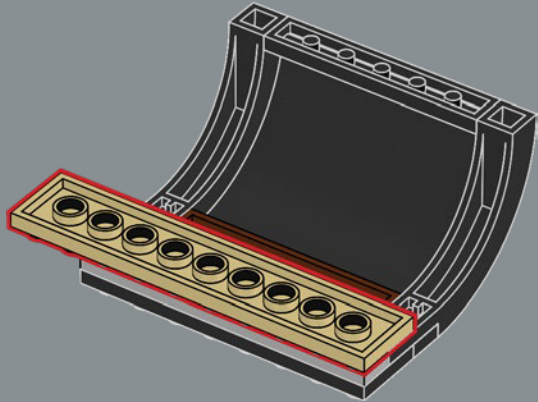

7

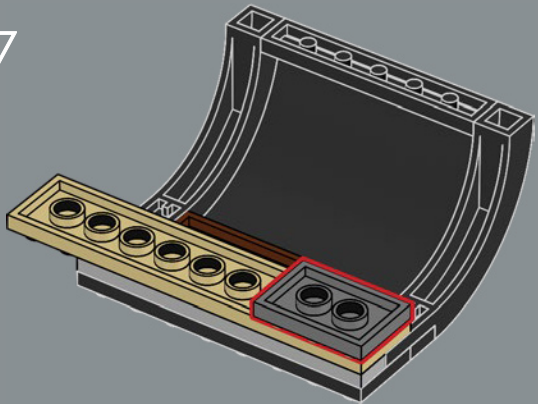

8

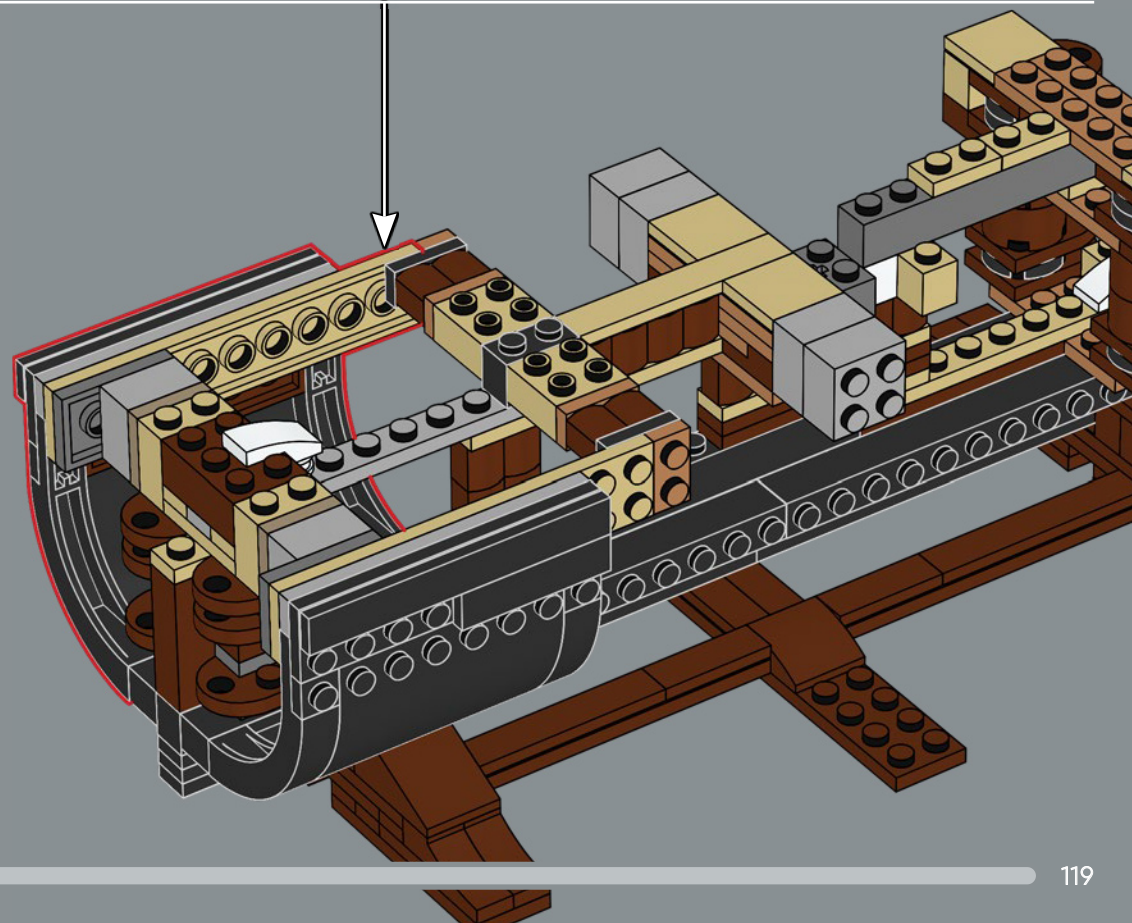
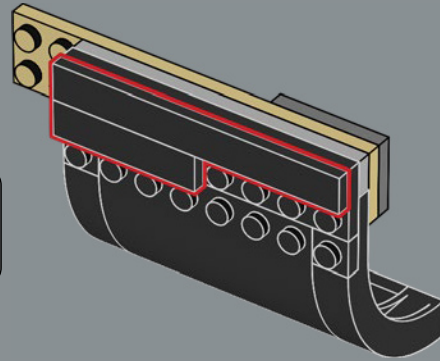

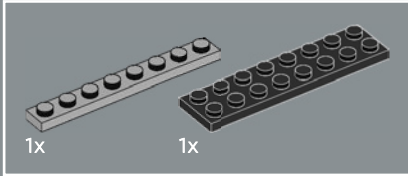
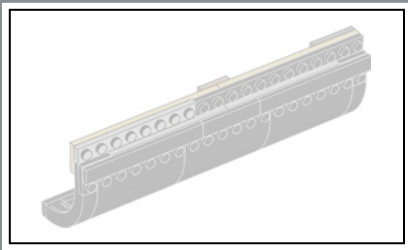

183

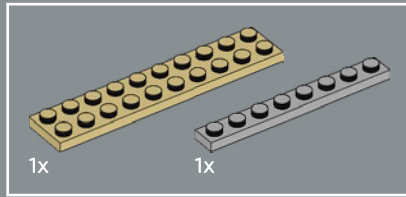
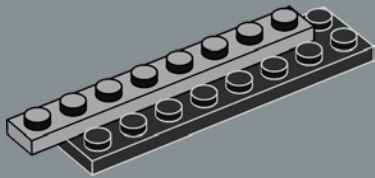

184

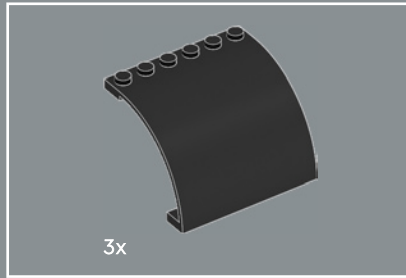
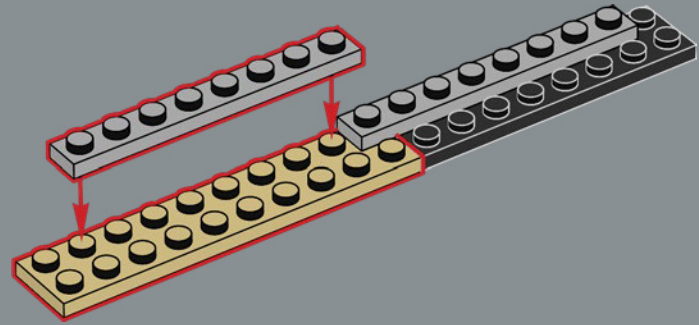

185

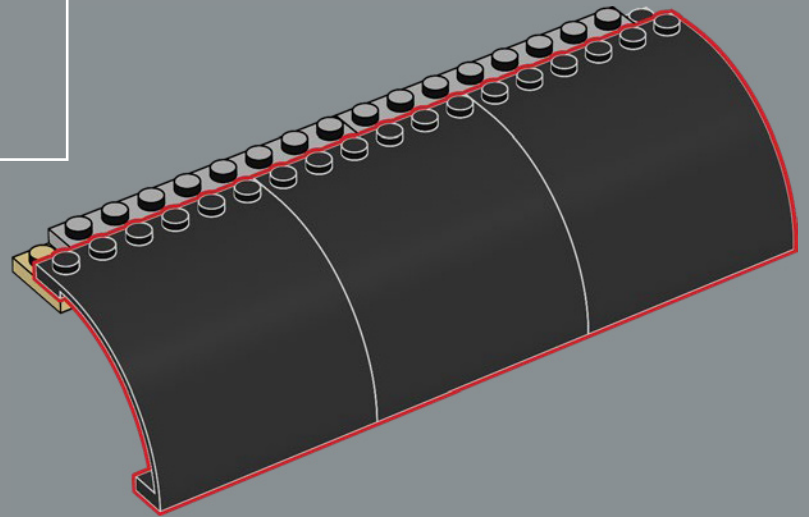

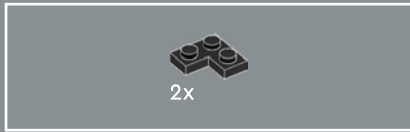

186

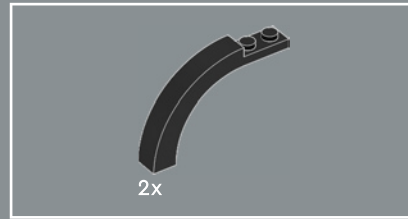
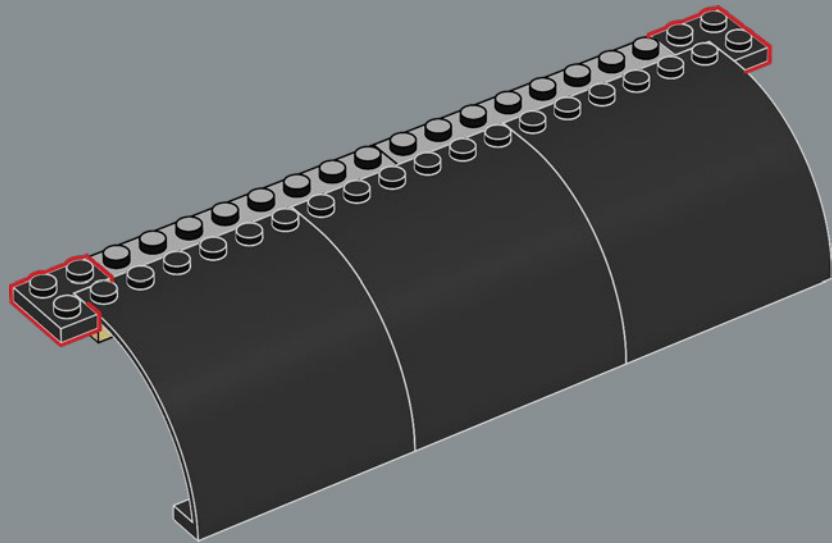

187

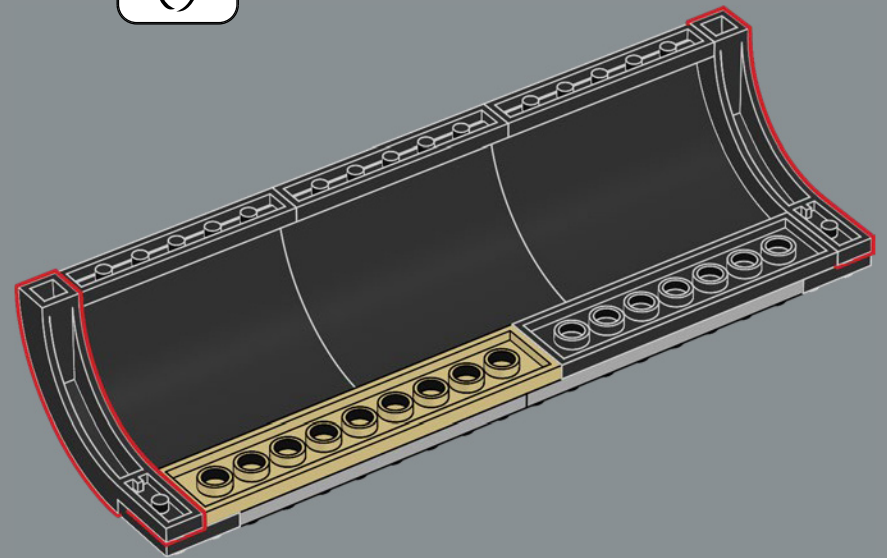

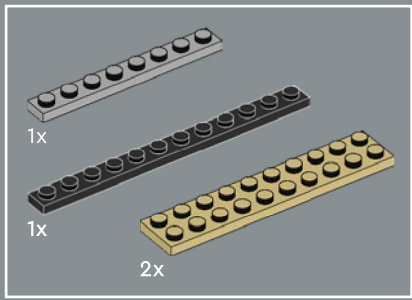

188

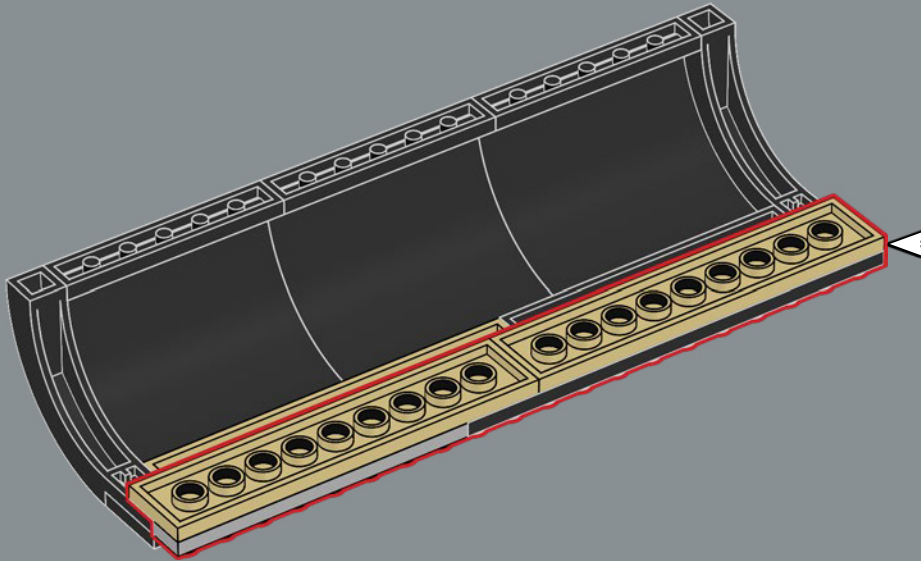
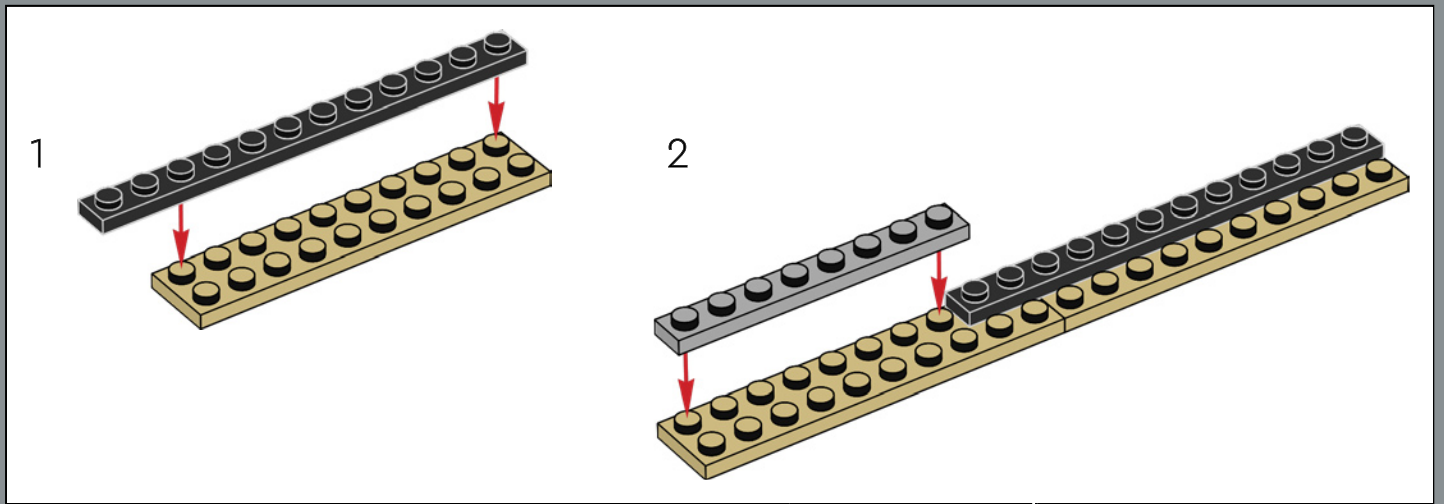



189

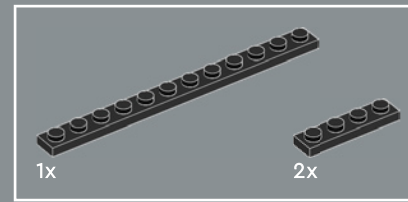
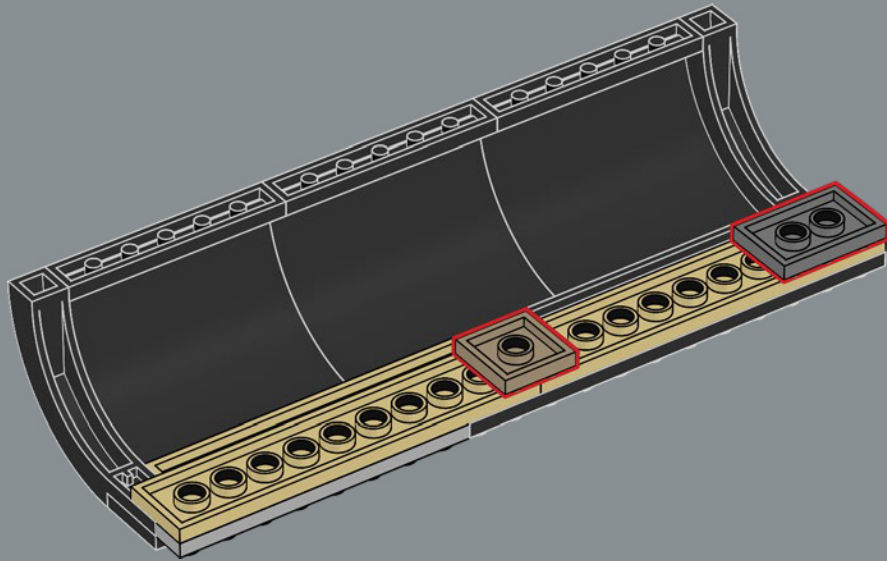

190

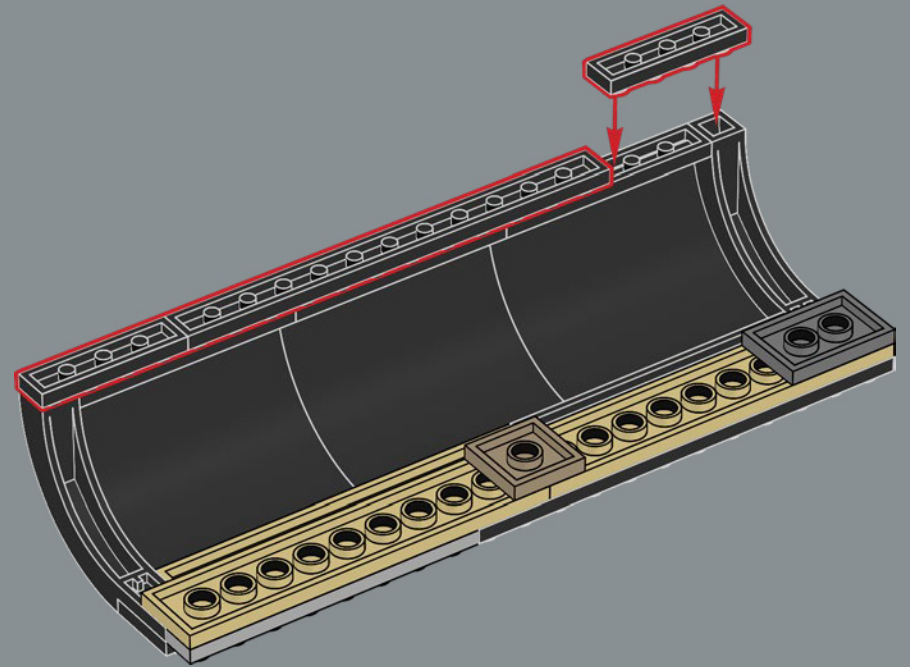

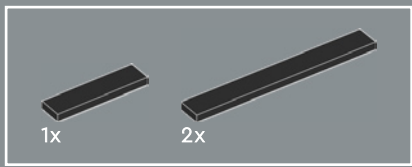

191

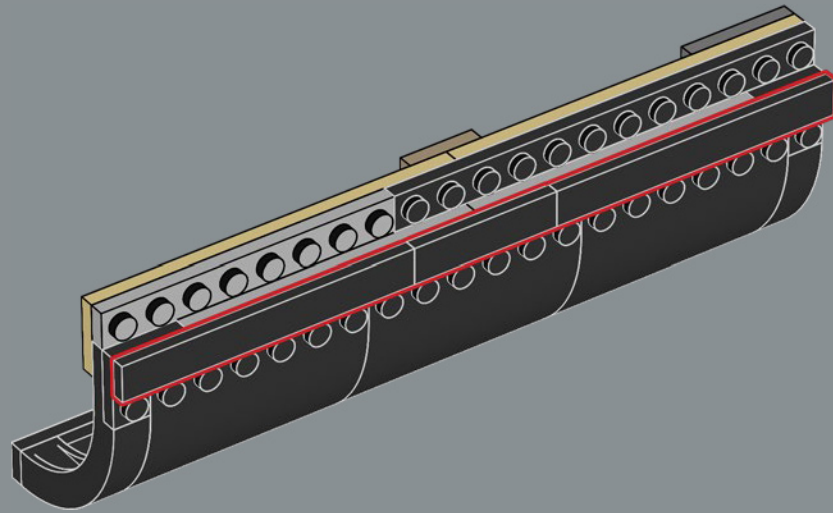

192

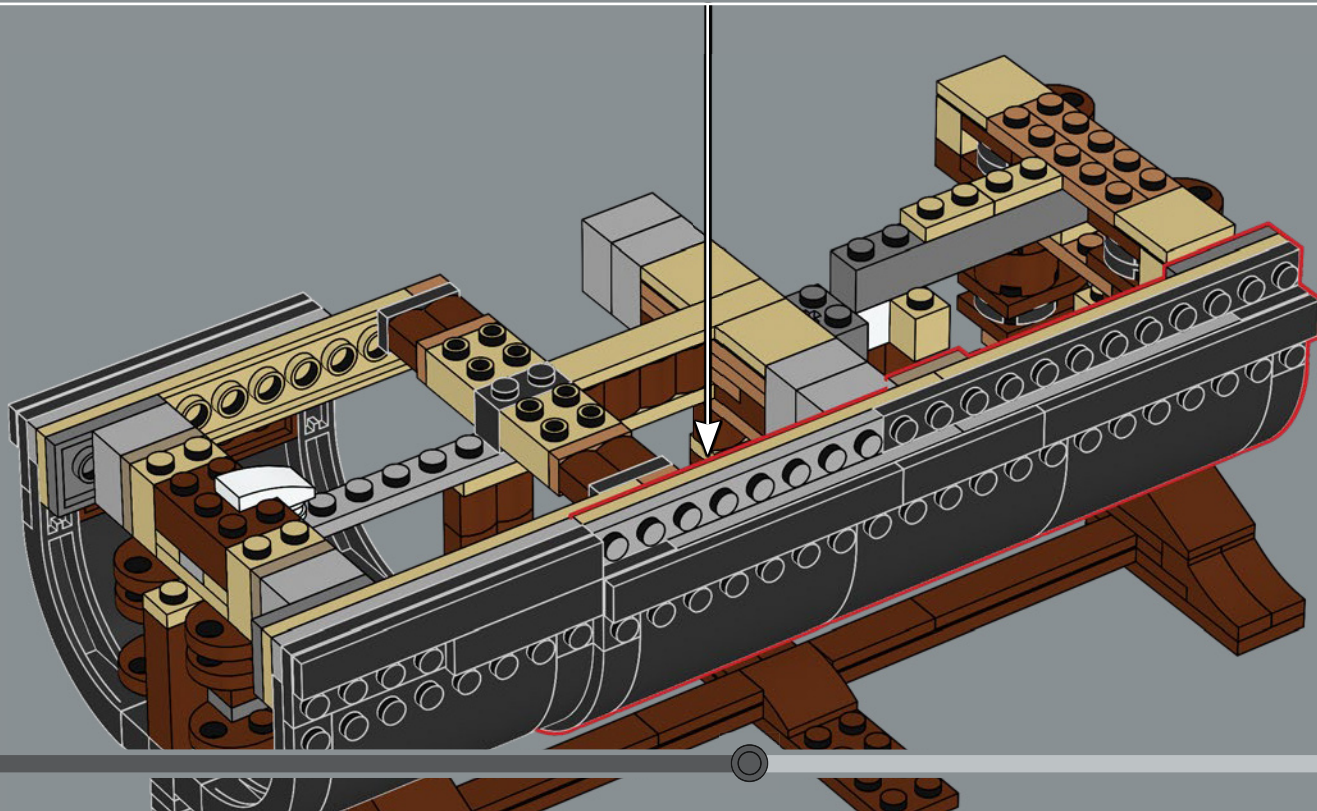

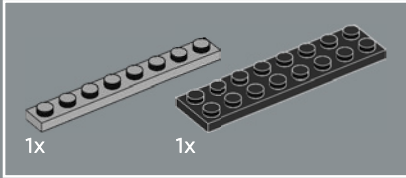
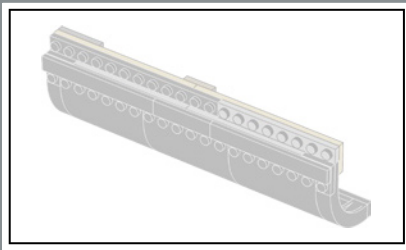

193

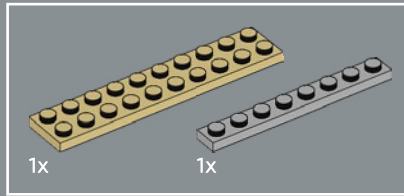
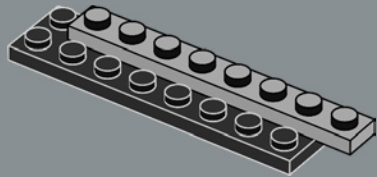

194

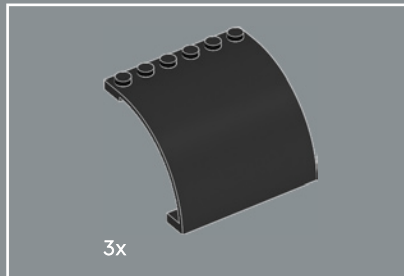

195



En términos de diseño LEGO®, los paneles negros que conforman la mayor parte de la zona inferior del casco se consideran elementos de pared. En color negro y con su tamaño y forma particulares resultaron perfectos para el casco del barco.

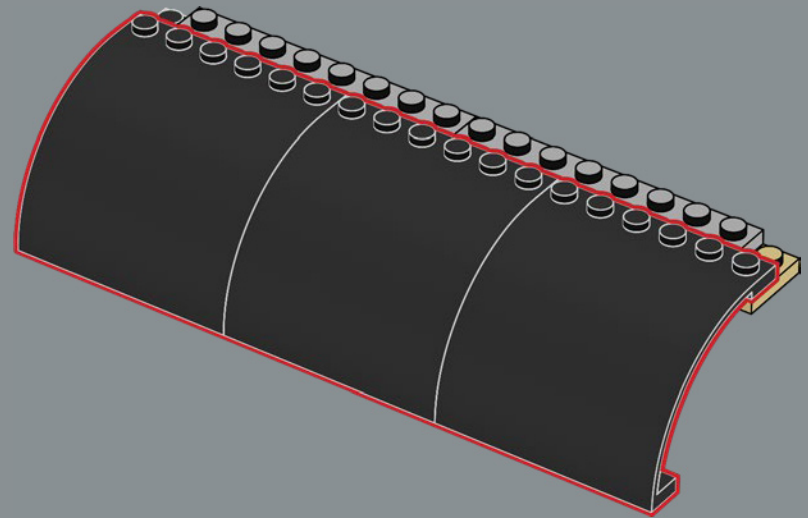
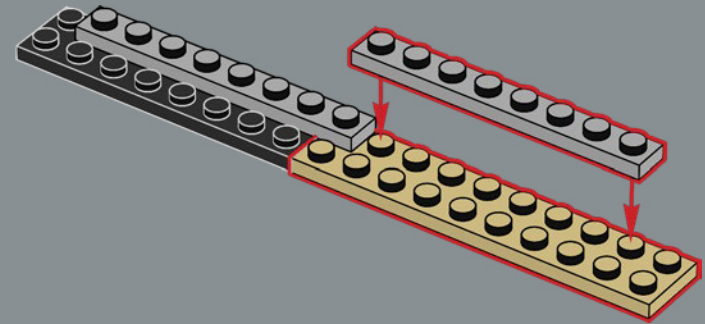

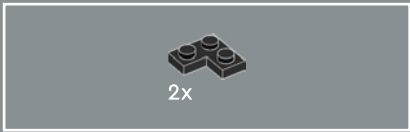

196

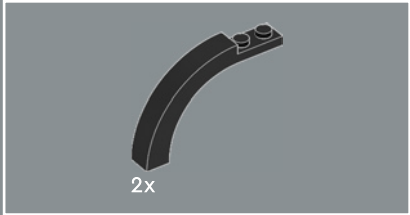
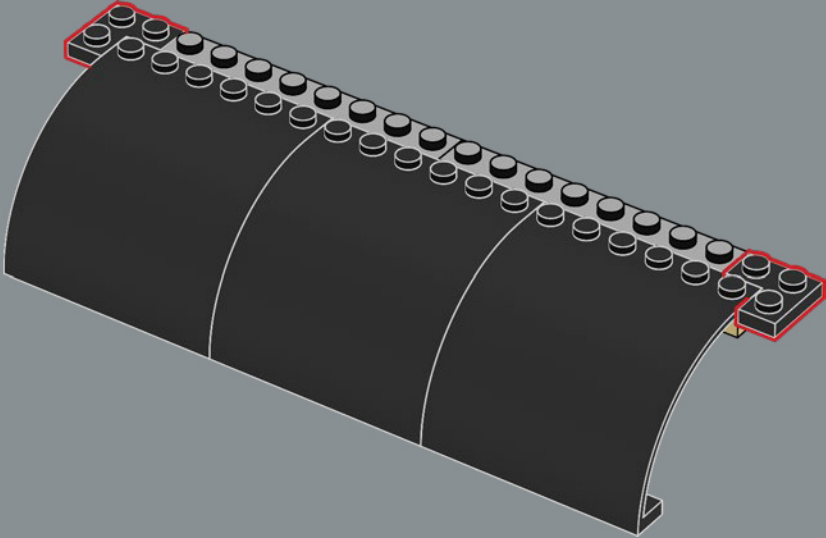

197

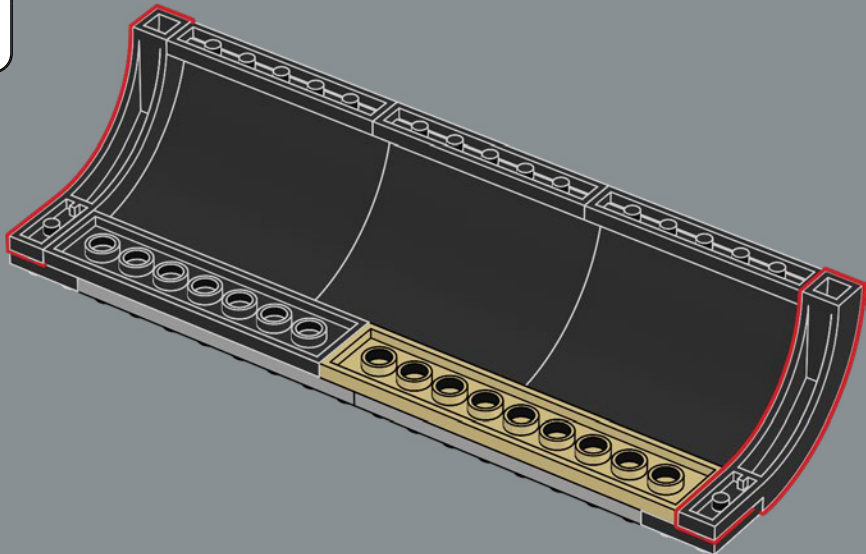

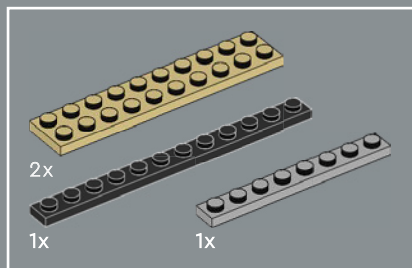

198

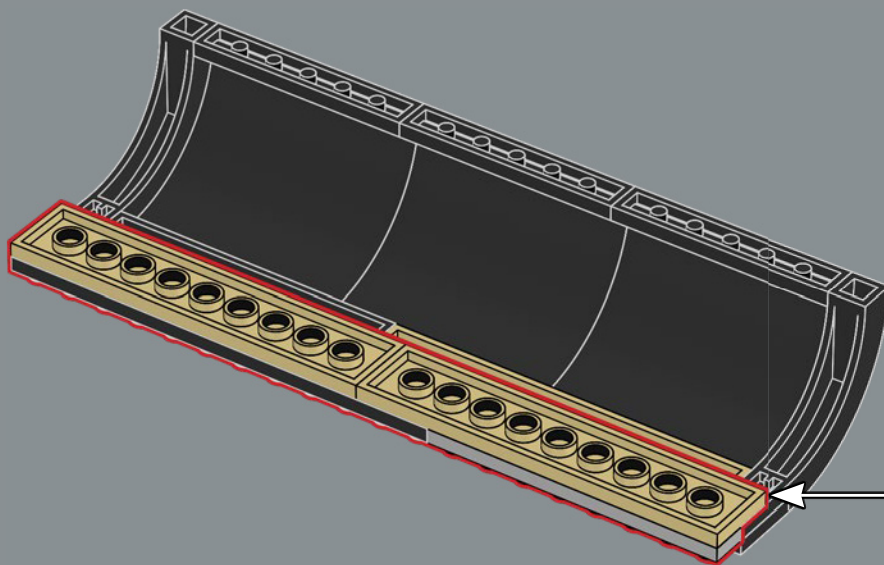
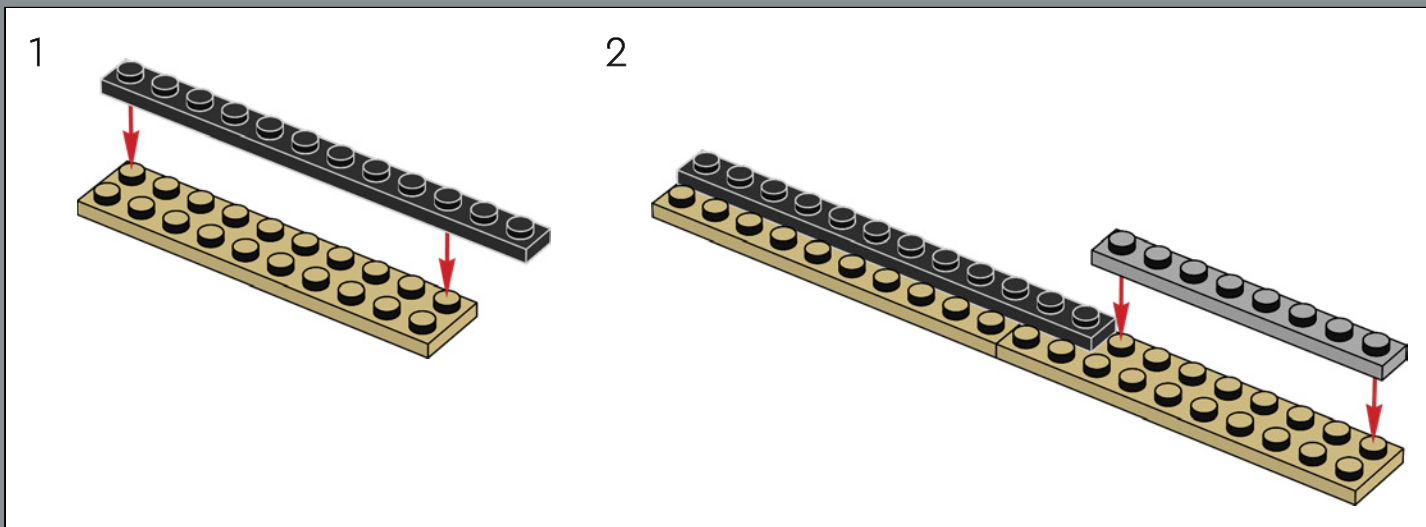



199

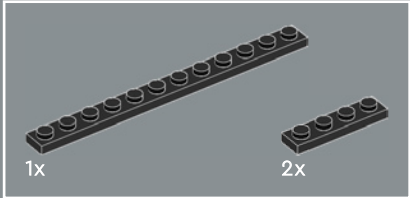
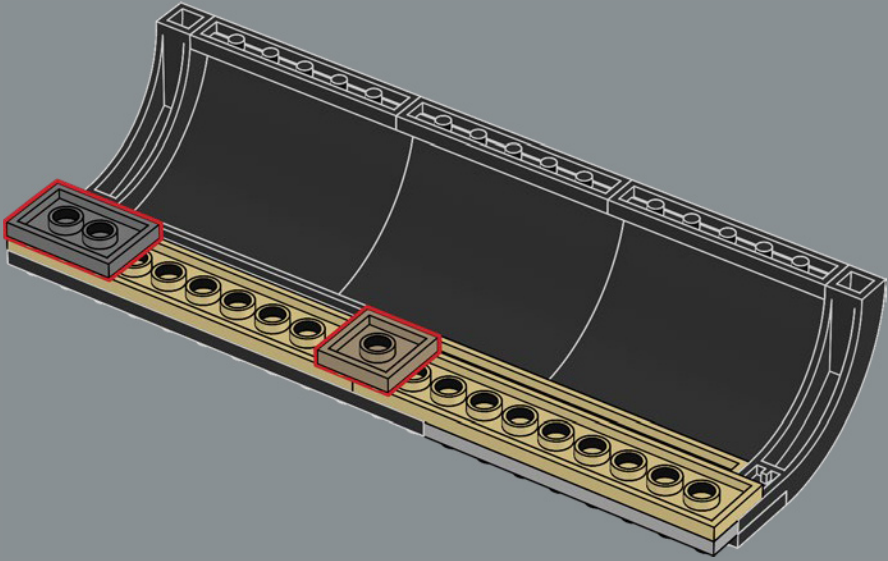

200

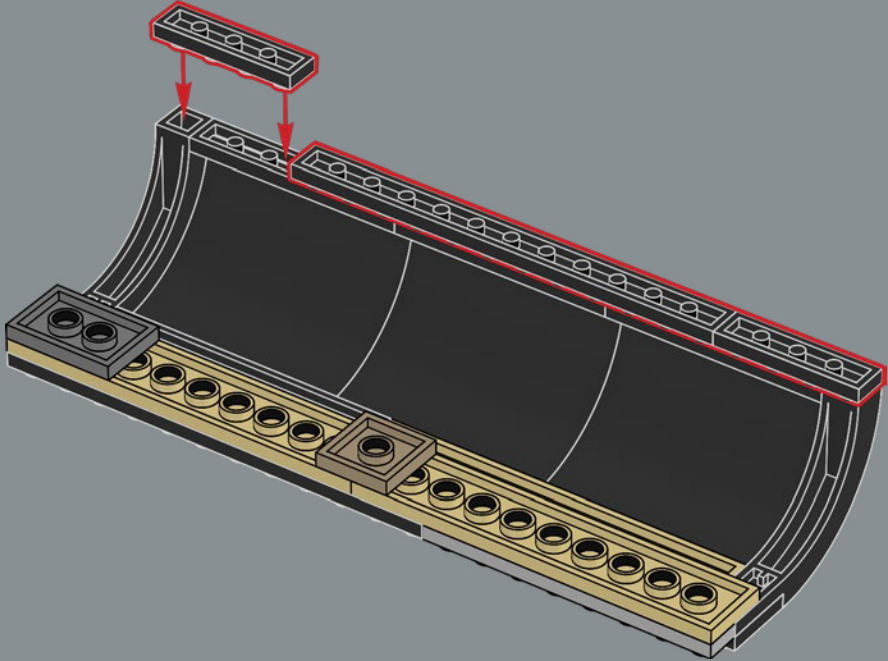

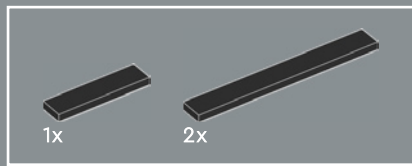

201

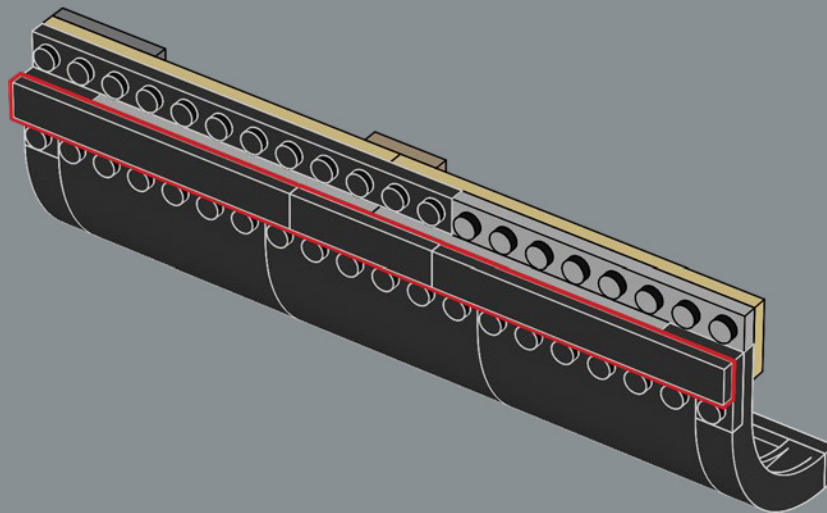

202

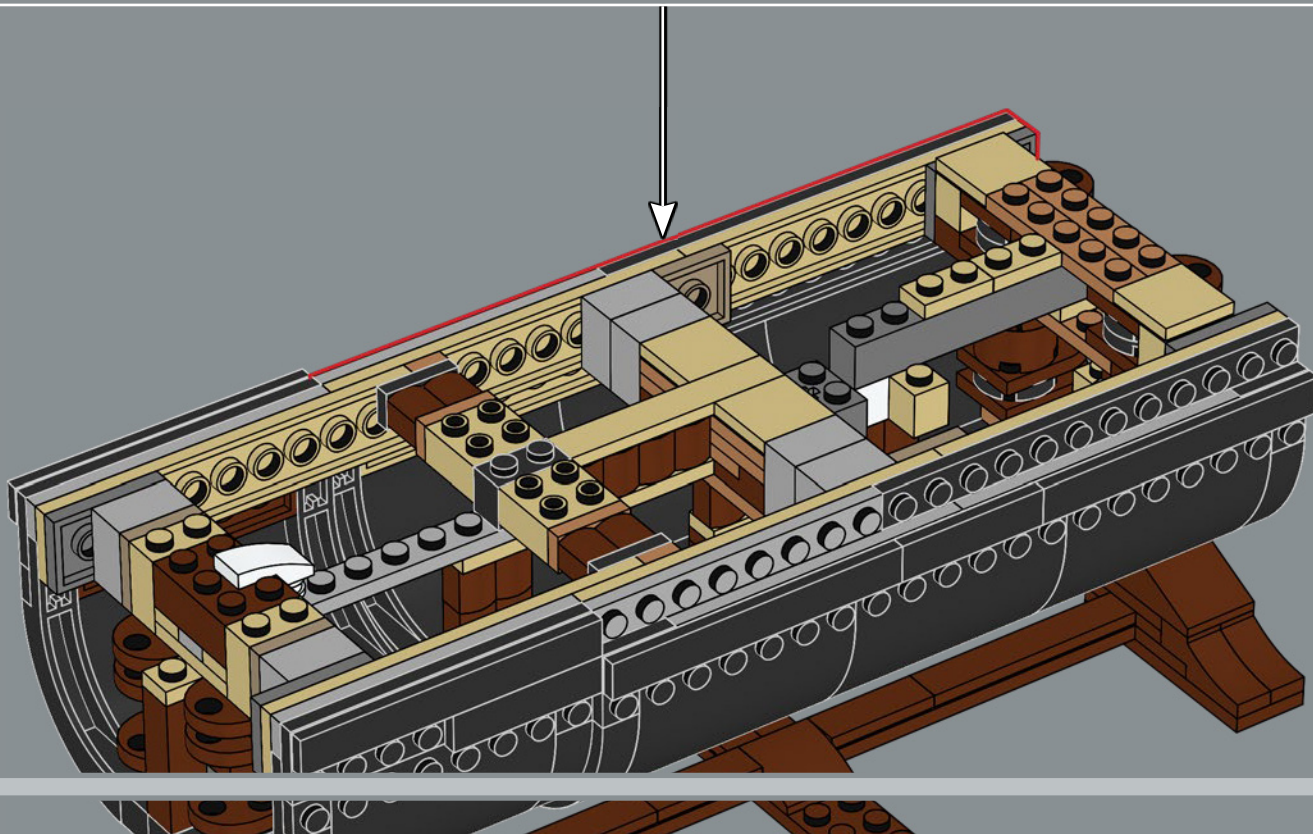

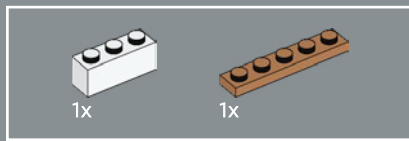
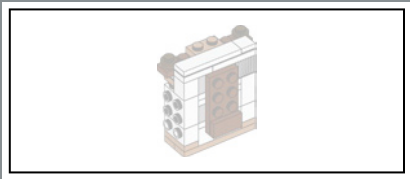

203

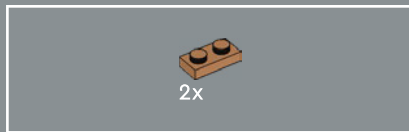
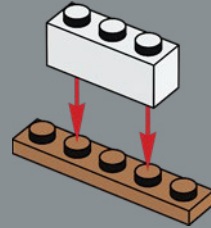

204

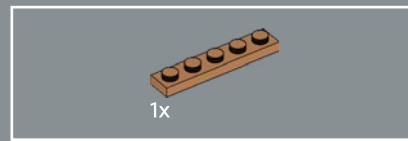
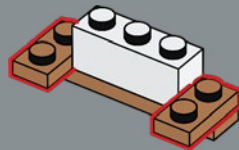

205

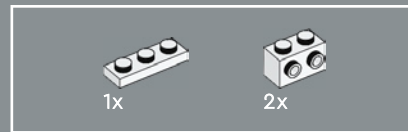
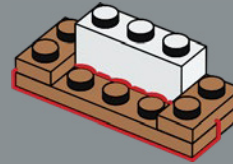

206

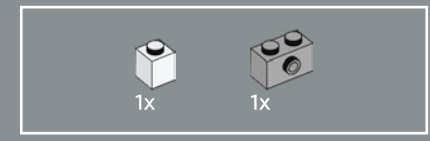
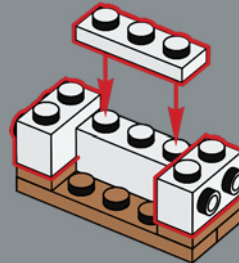

207

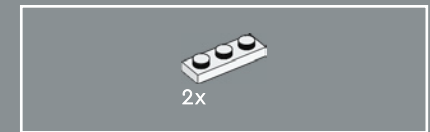
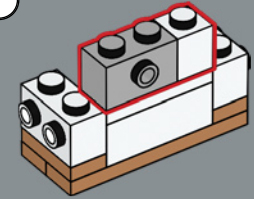

208

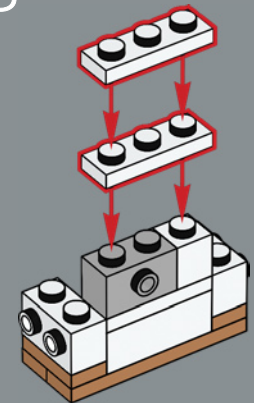

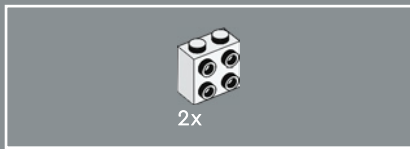

209

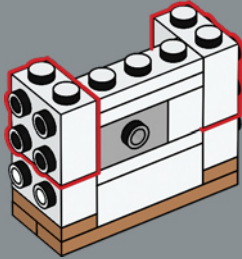

210

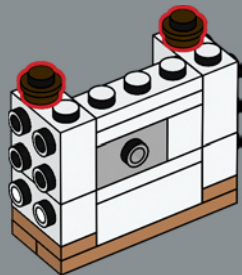

211

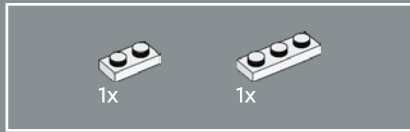
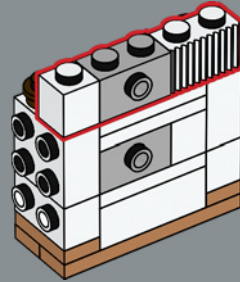

212

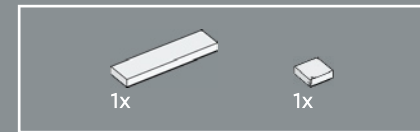
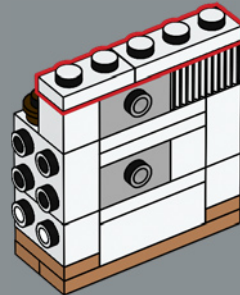

213

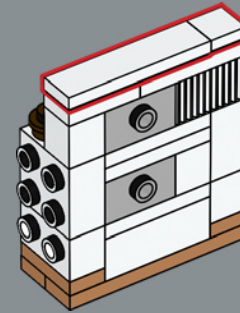

214

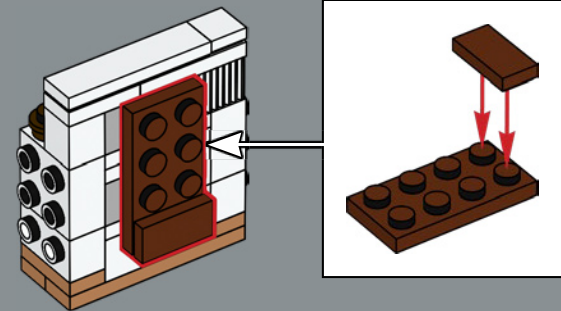

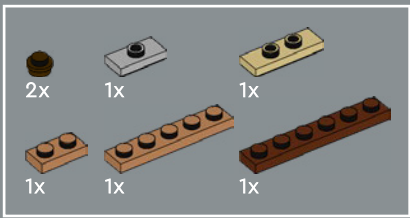

215

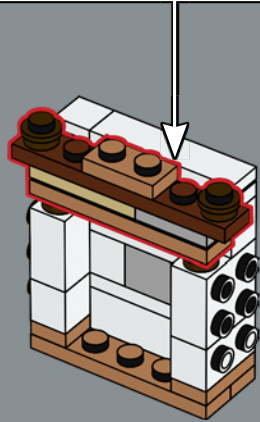
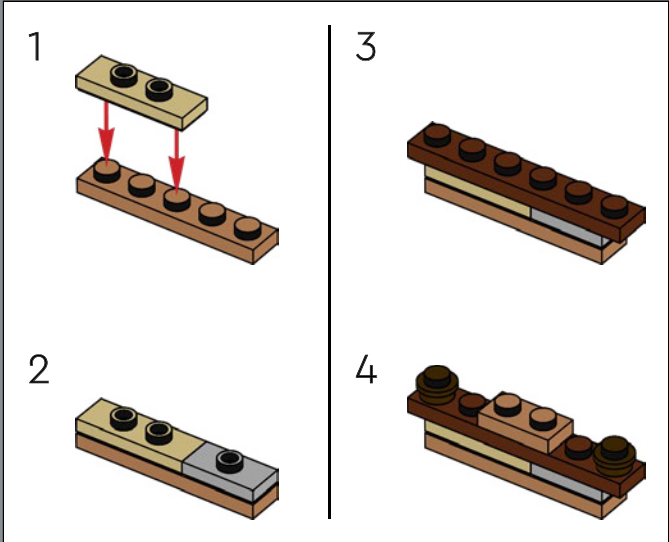

216

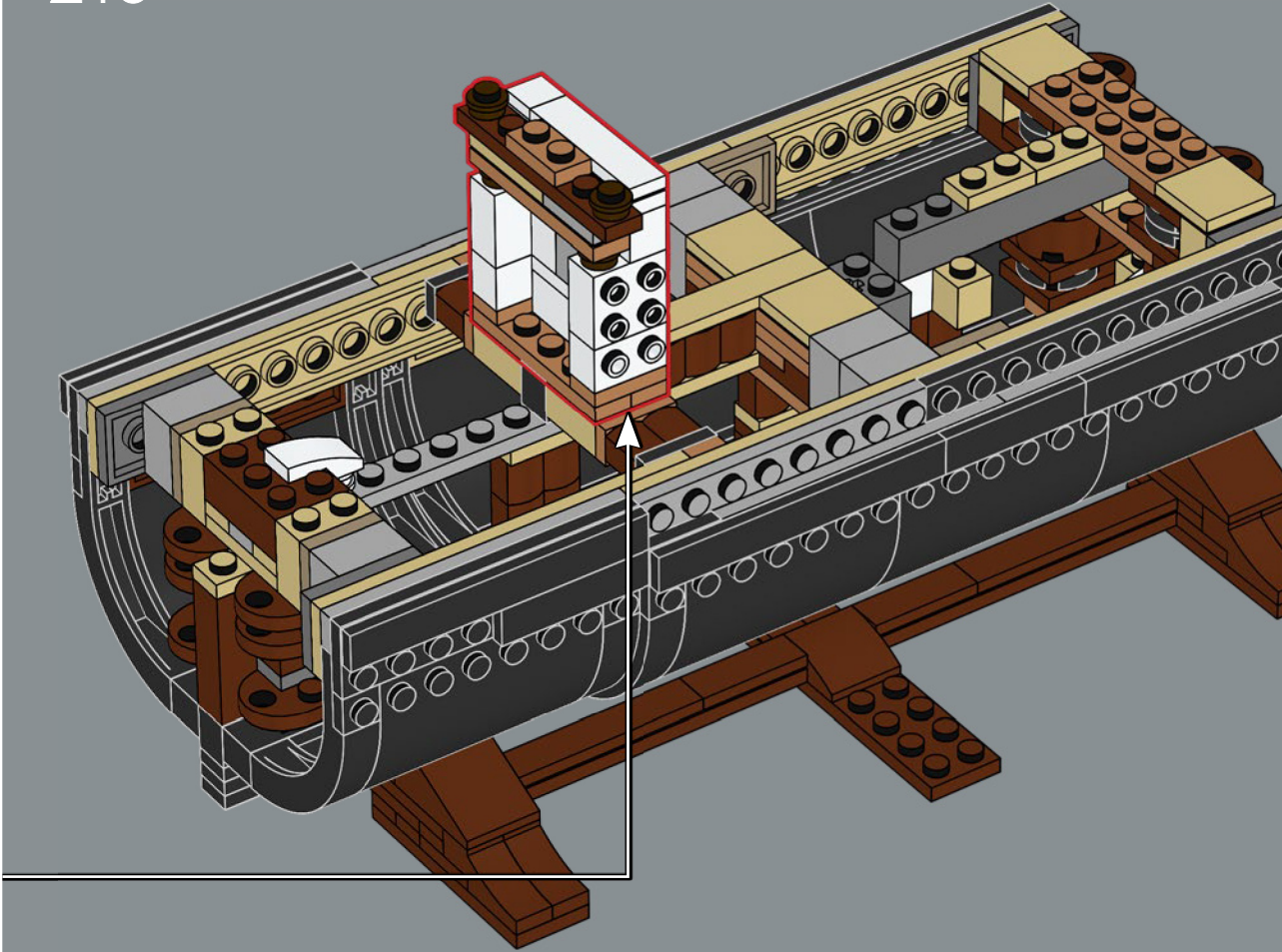

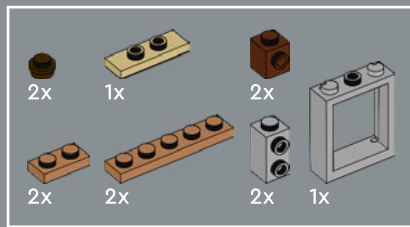

217

1

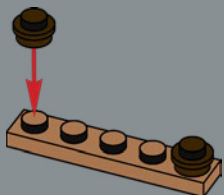

2

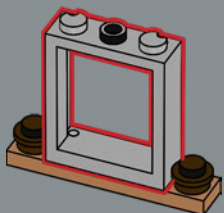

3

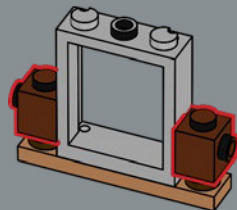

4

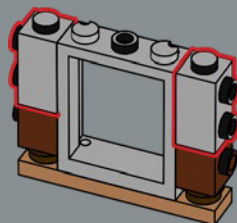

5

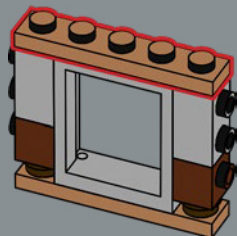

6

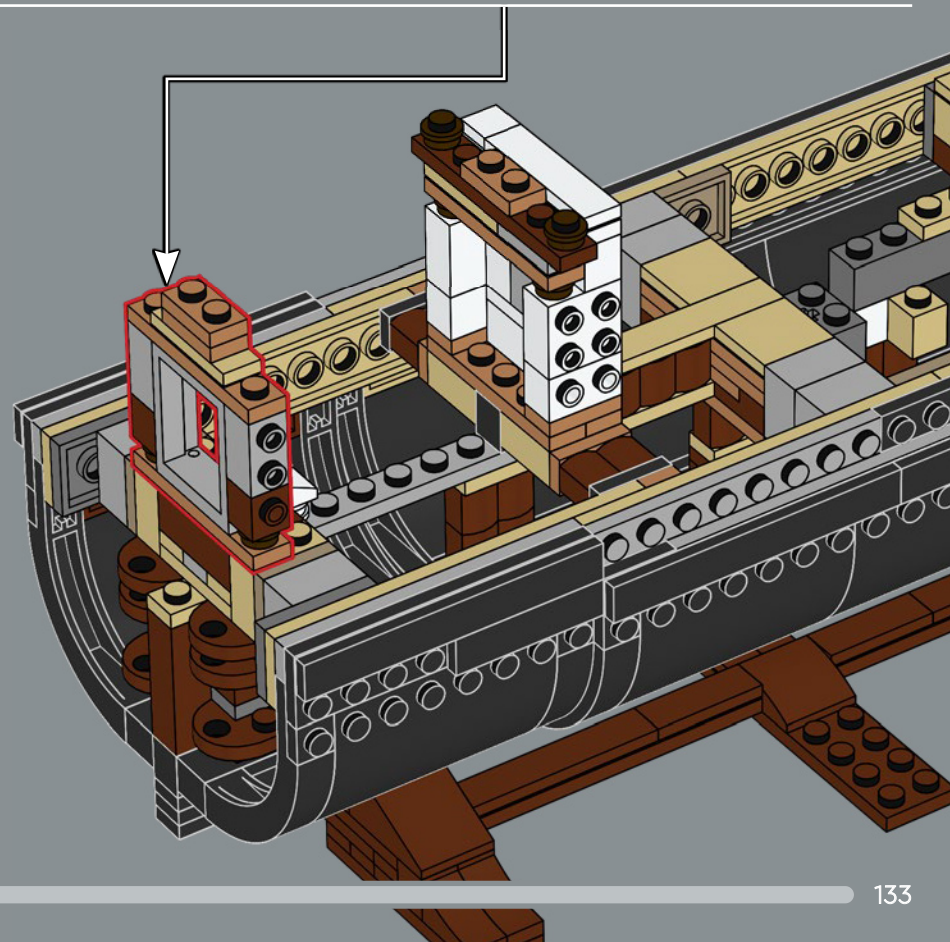
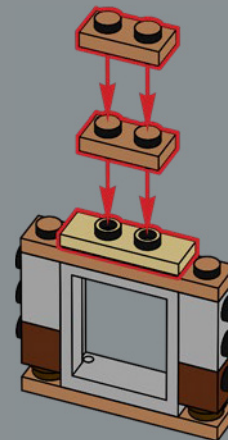

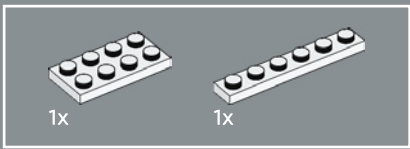

218

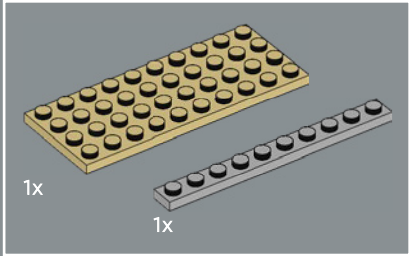
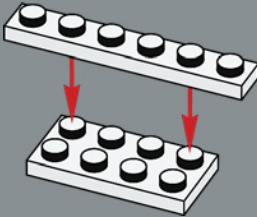

219

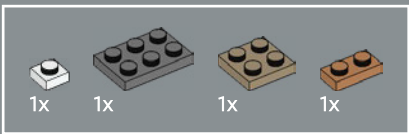
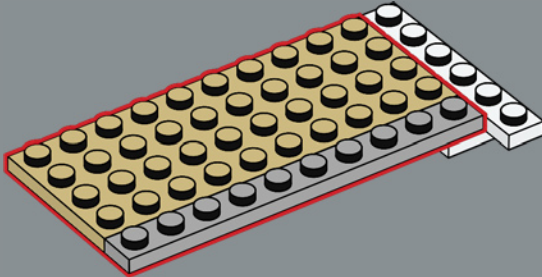

220

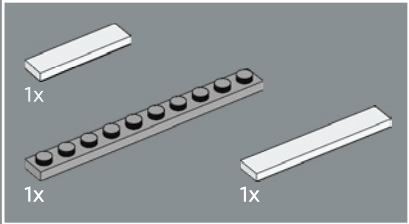
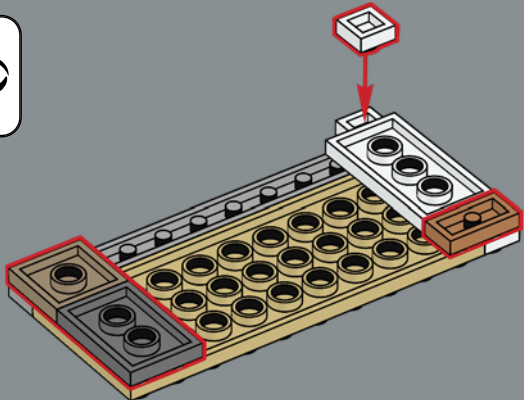

221

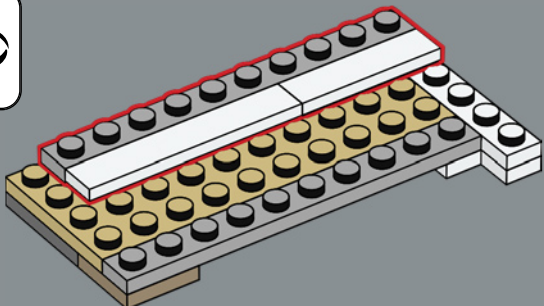

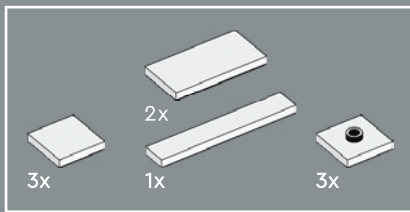

222

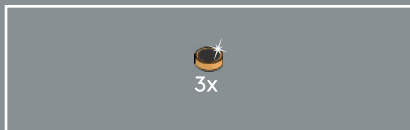
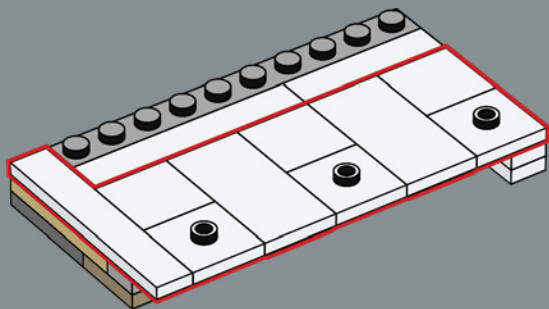

223

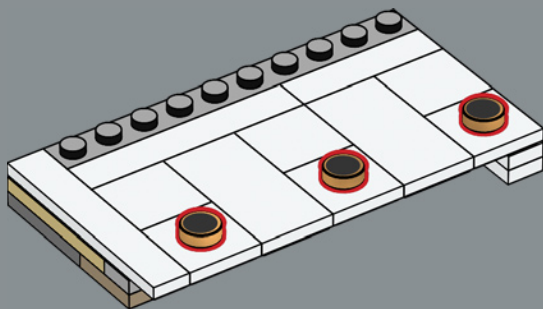

224

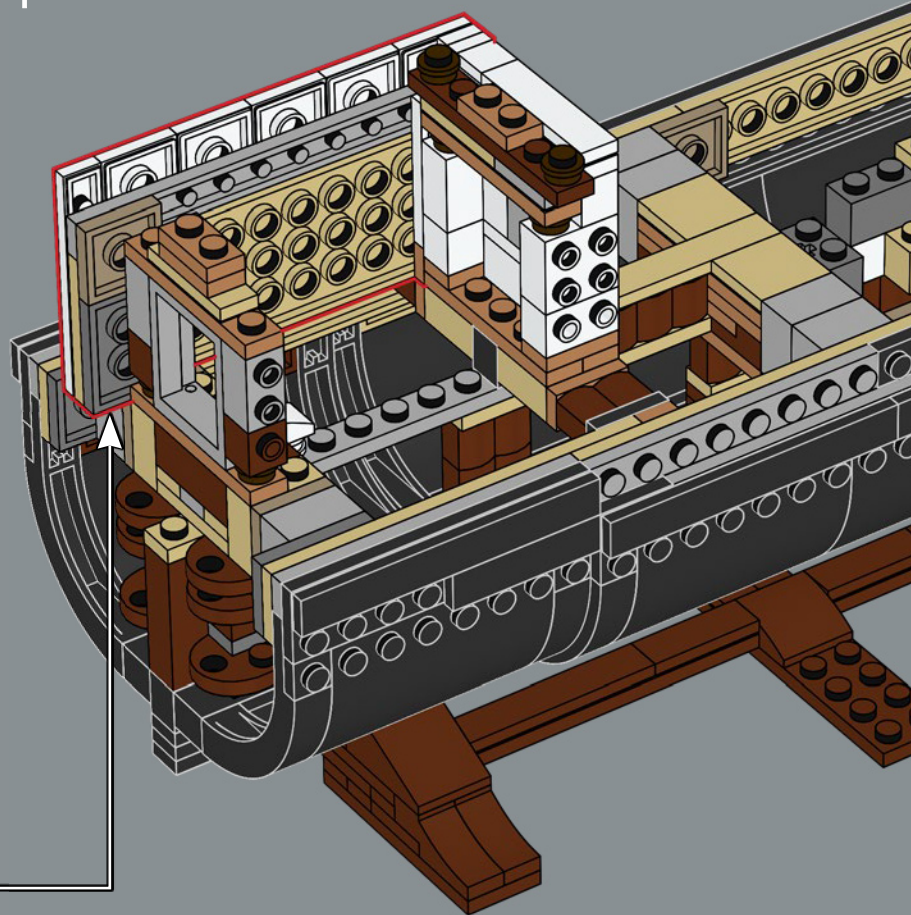

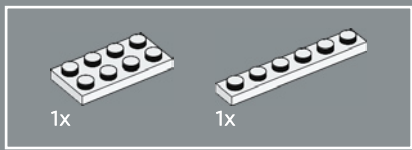

225

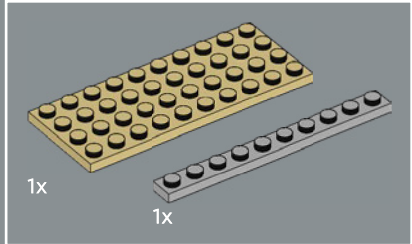
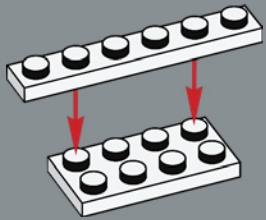

226

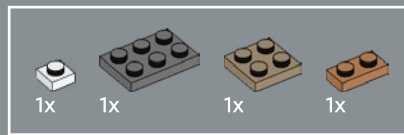
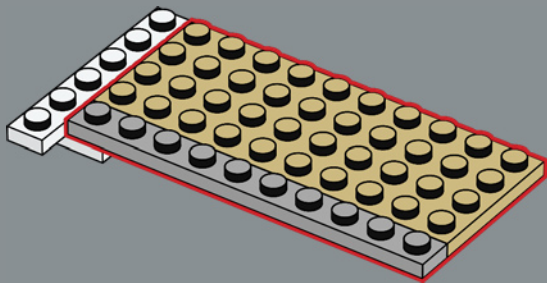

227

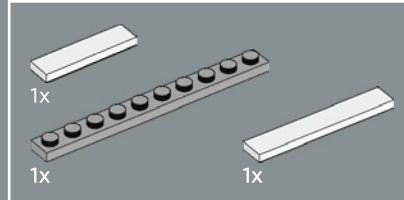
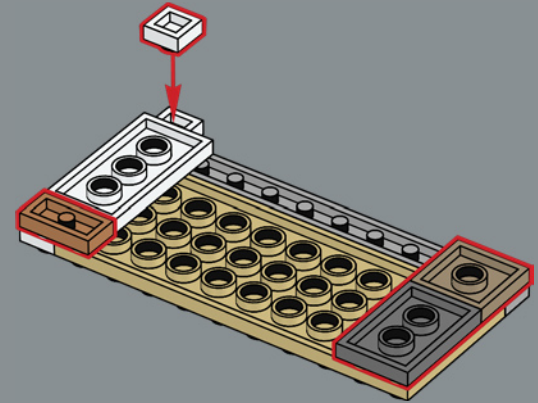

228

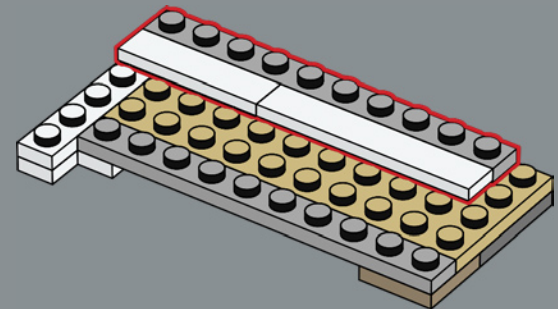

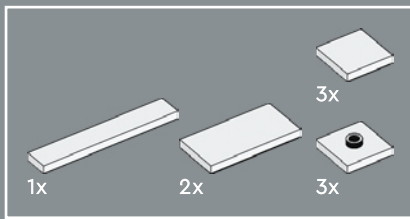

229

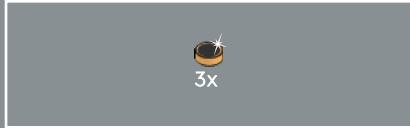
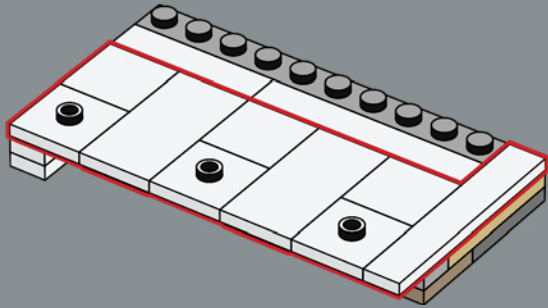

230

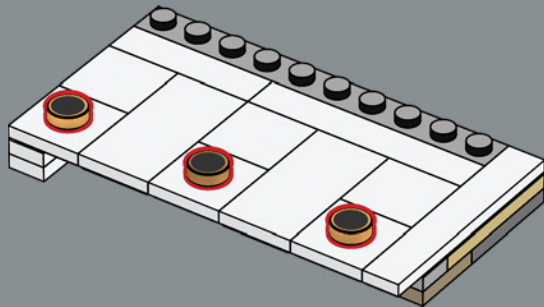

231

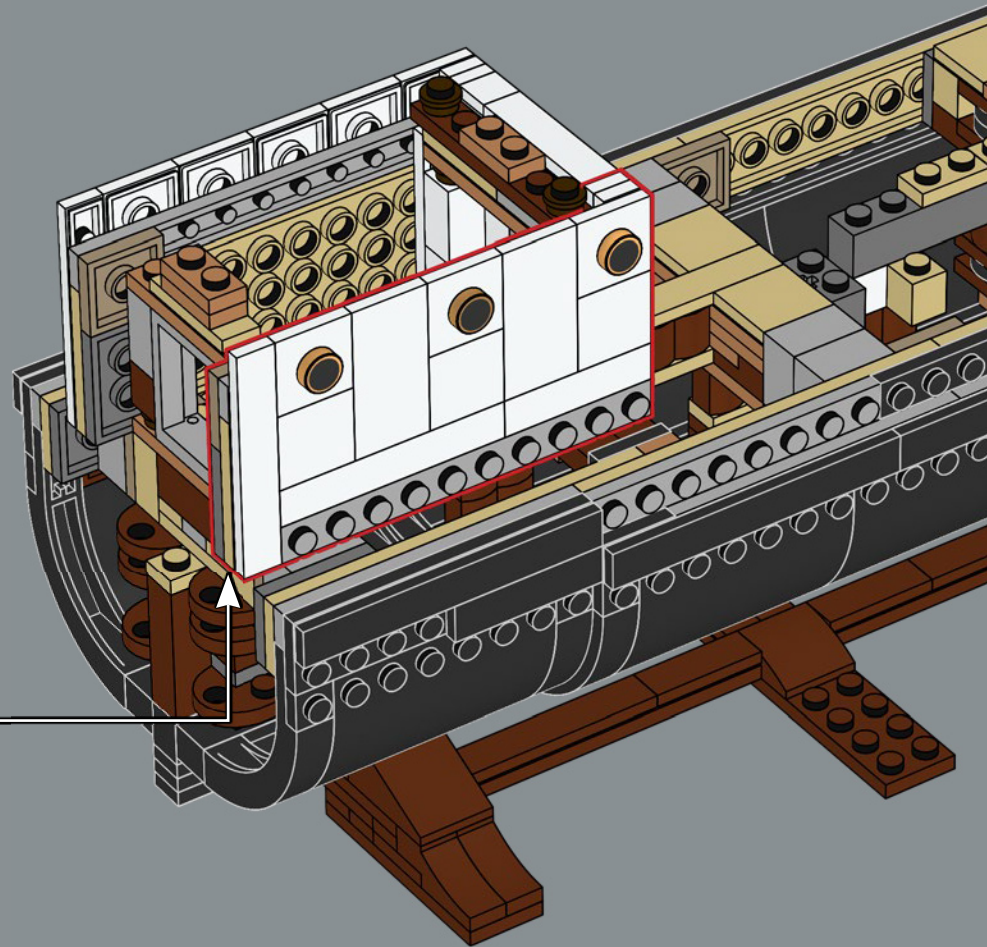



1

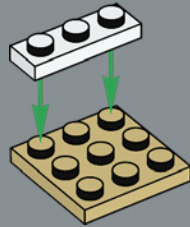

2



3

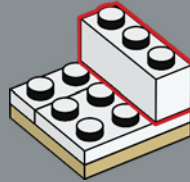

4

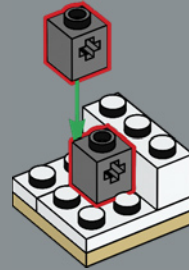

5

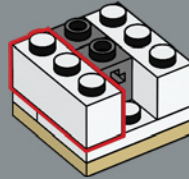

6

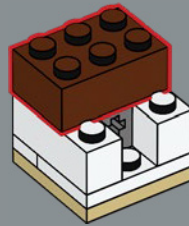

7

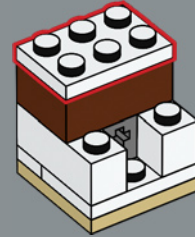

8

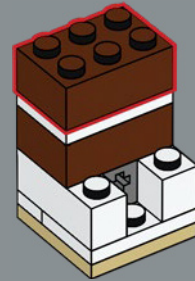

9

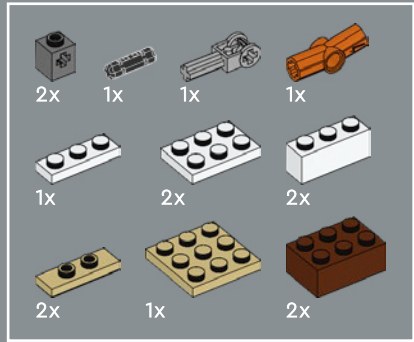
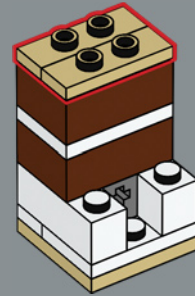

232

10

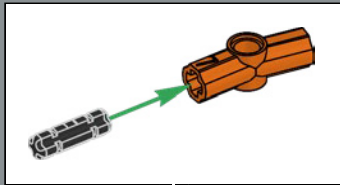
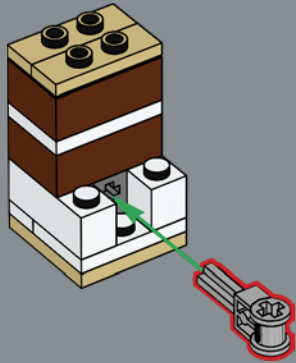

11

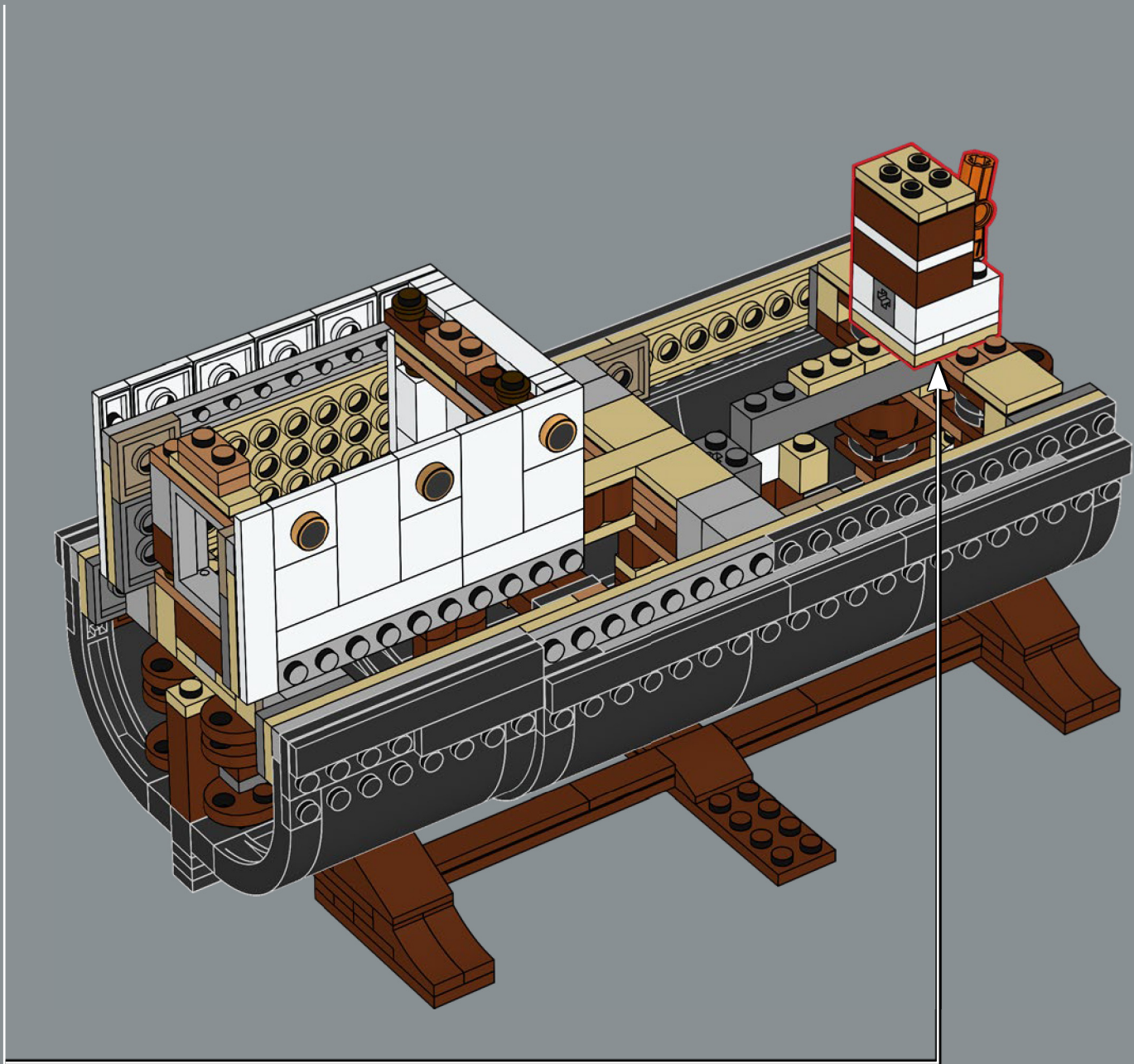
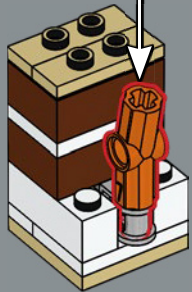

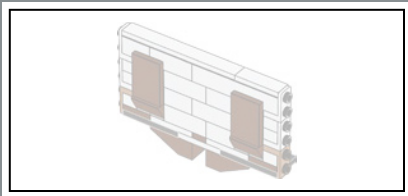

233

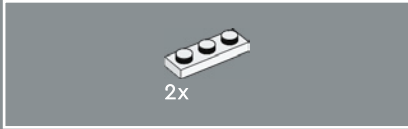
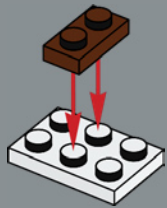

234

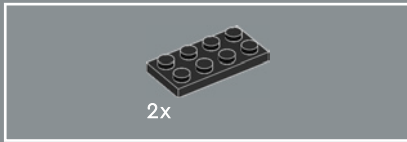
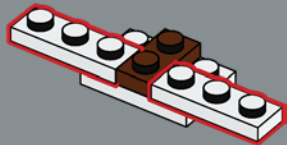

235

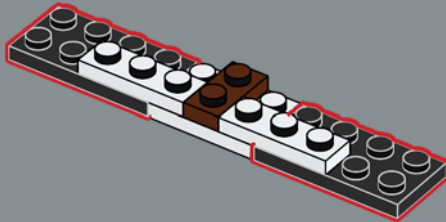

236

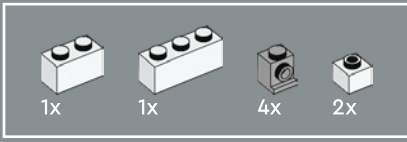
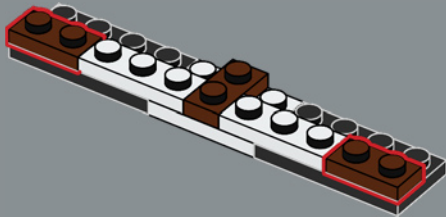

237

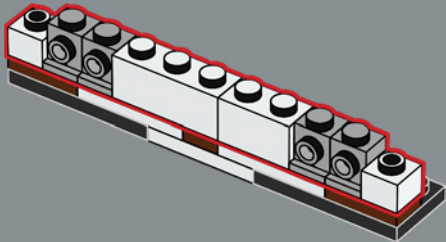

238

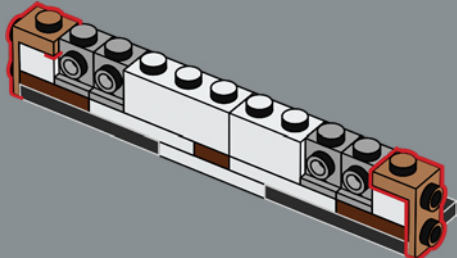

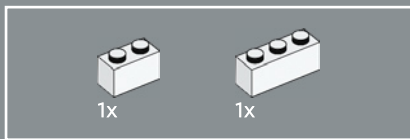

239

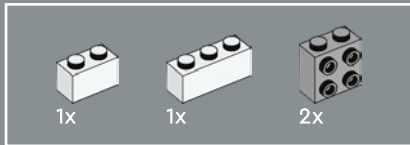
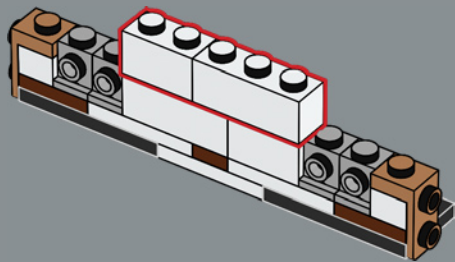

240

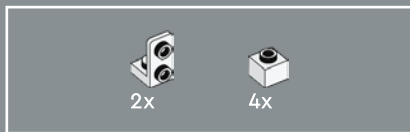
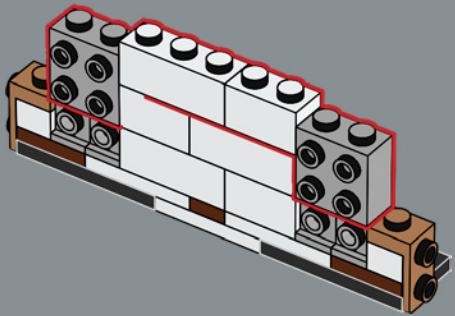

241

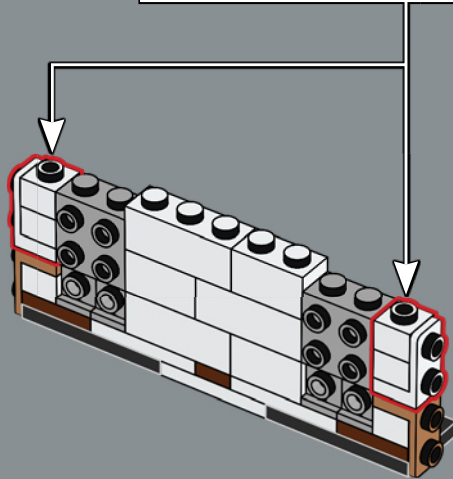
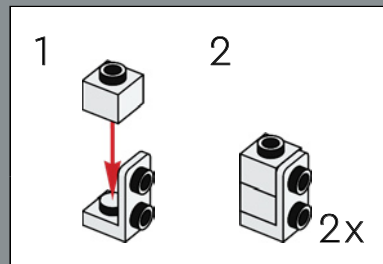

242

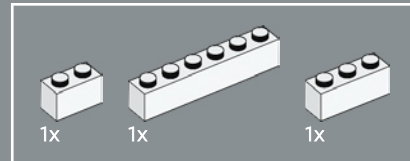
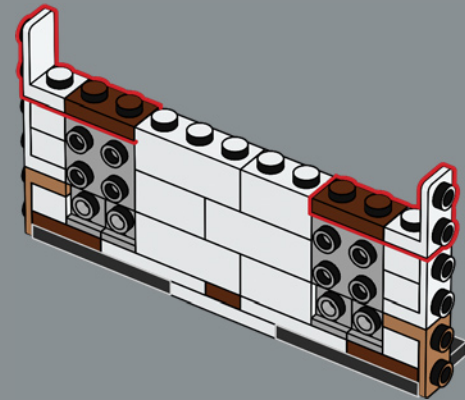

243

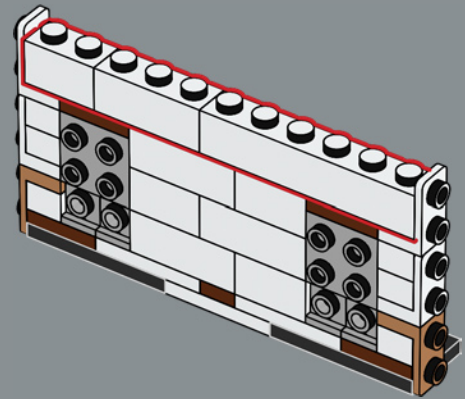

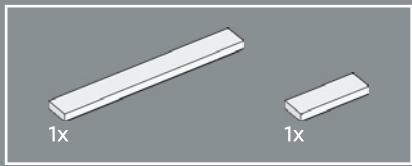

244

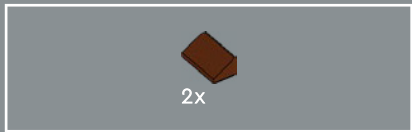
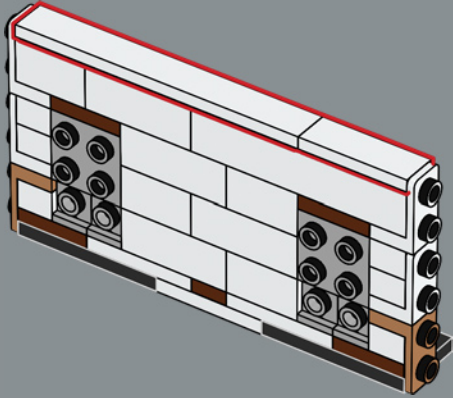

245

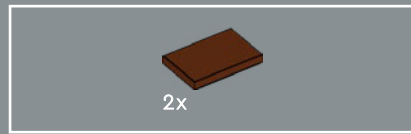
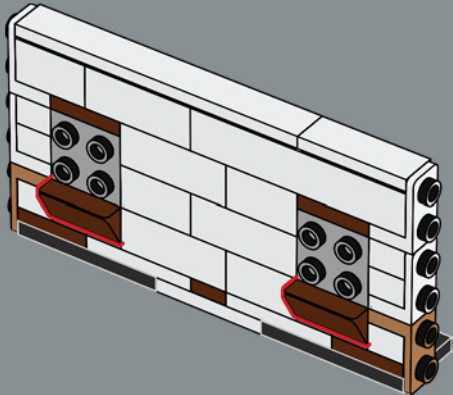

246

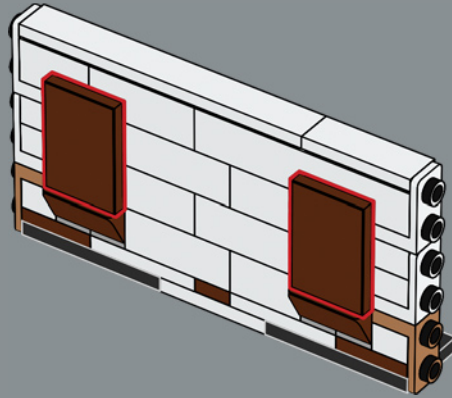

247

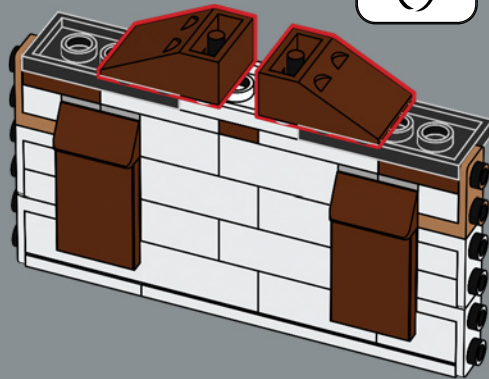

248

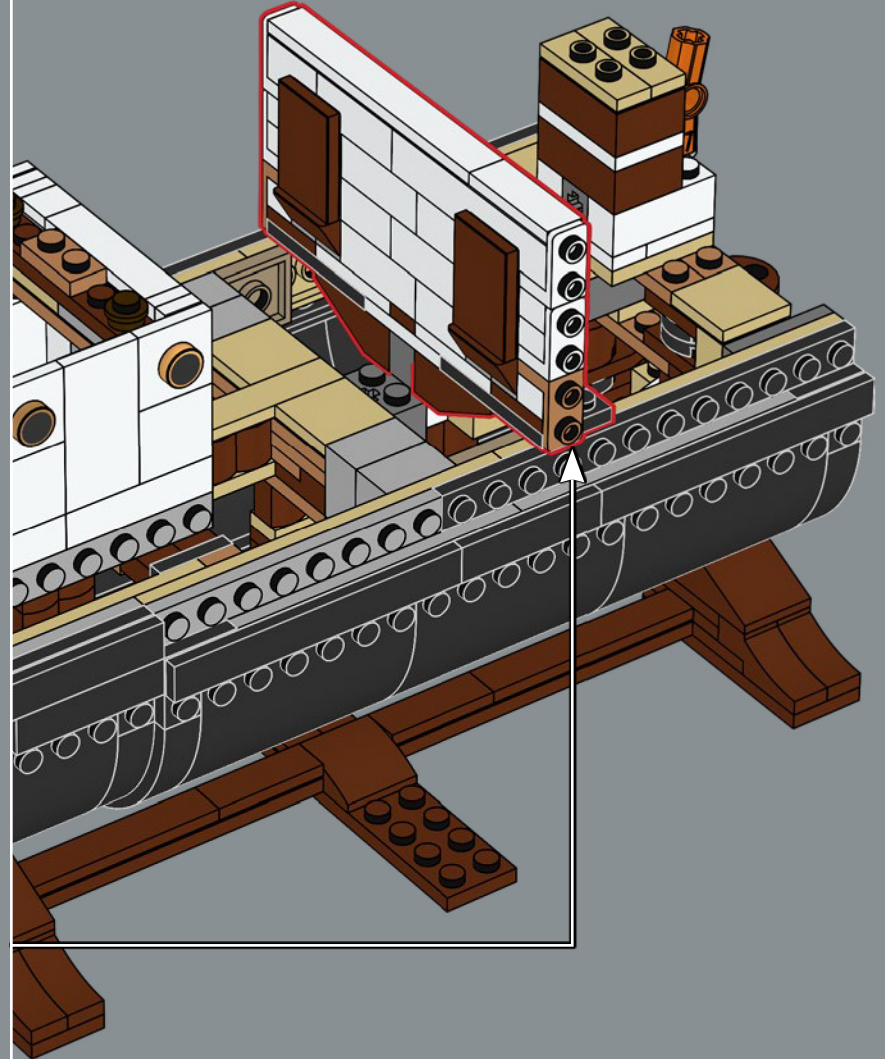

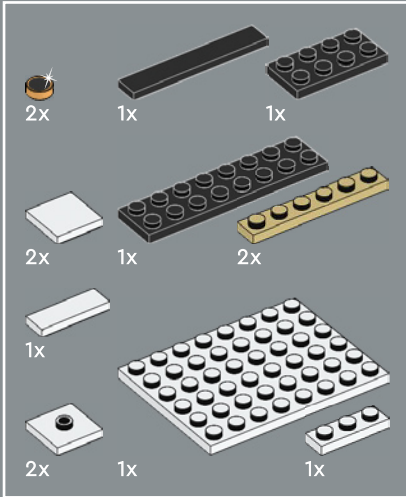
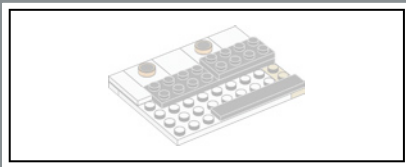

249

1

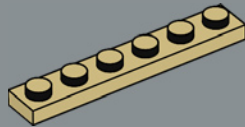

2

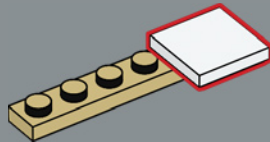

3

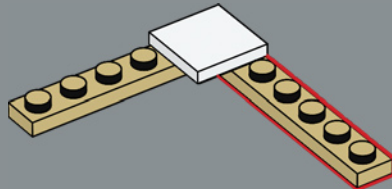

4

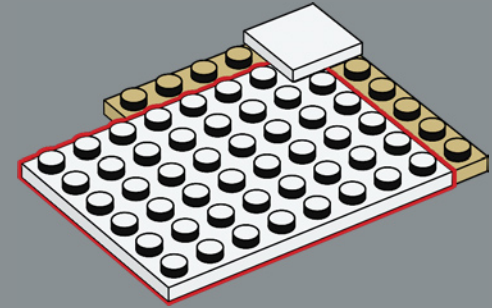

5

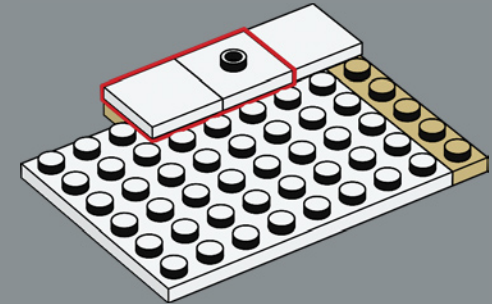

6

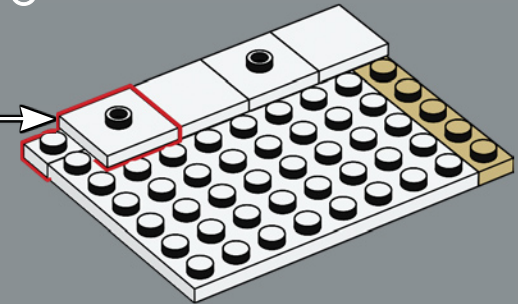
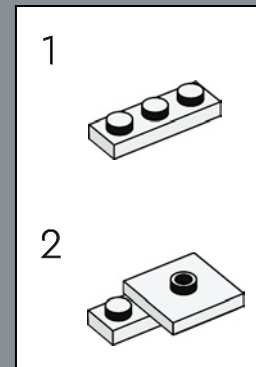

7

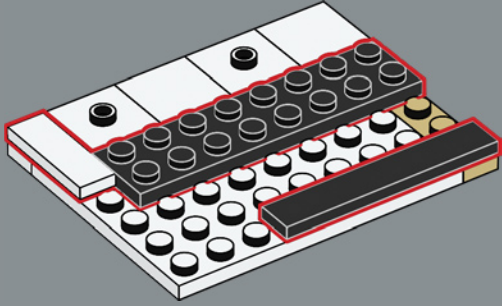

8

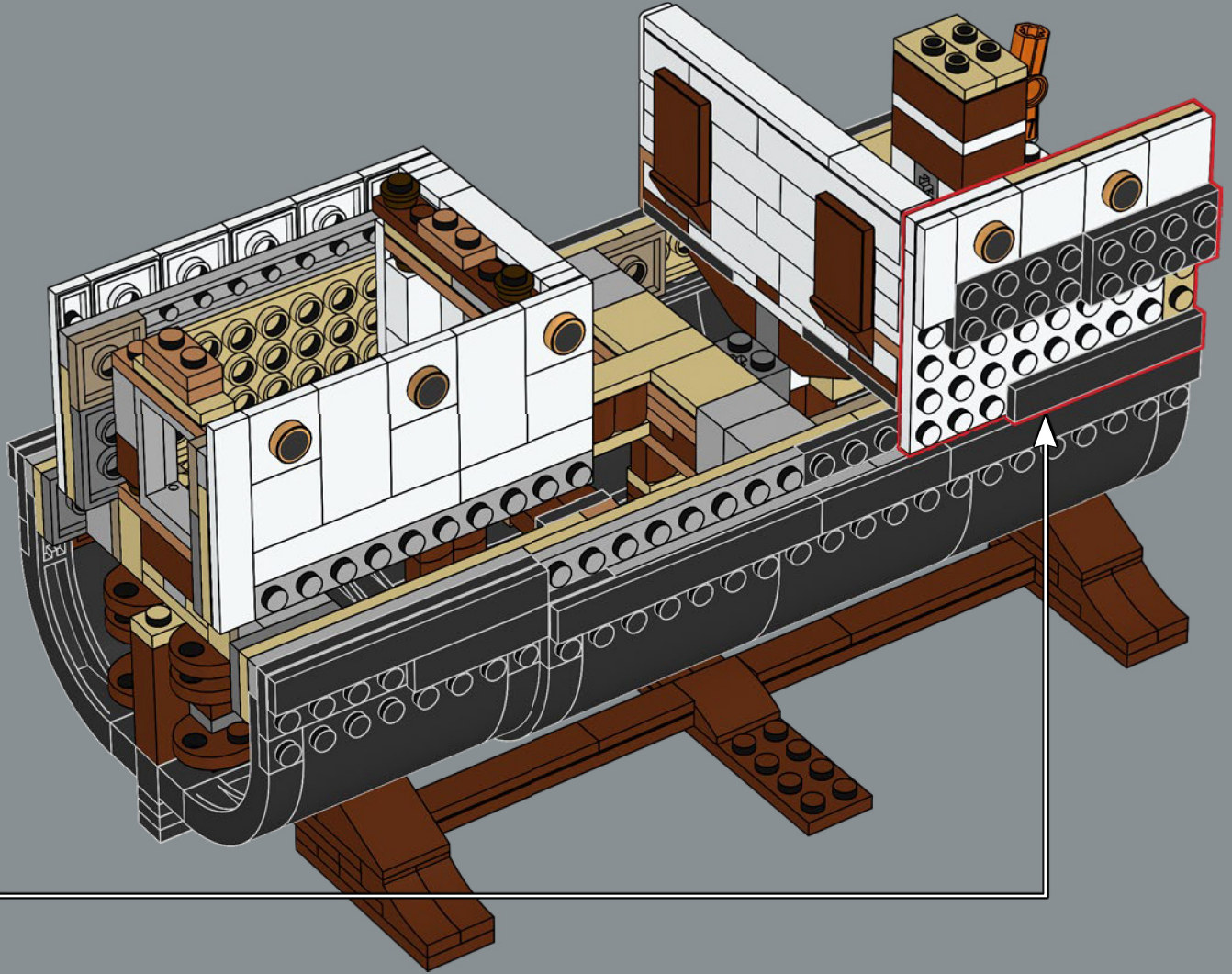
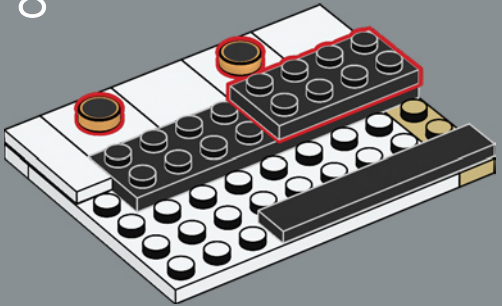

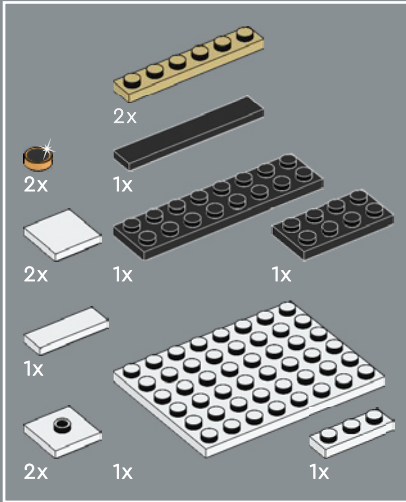
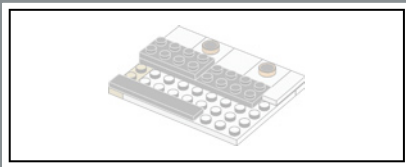

250

1

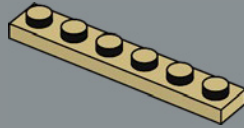

2

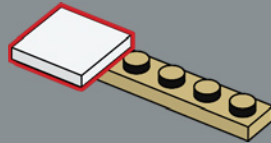

3

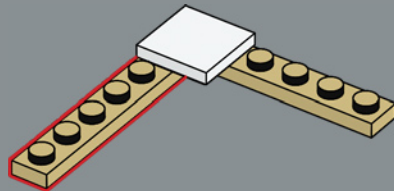

4

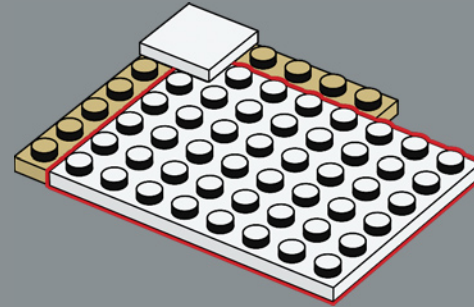

5

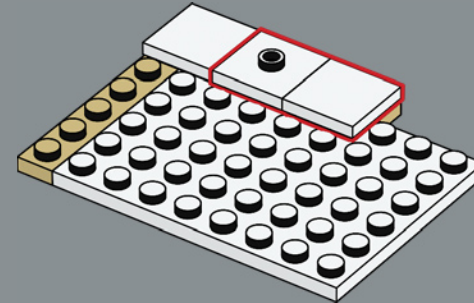

6

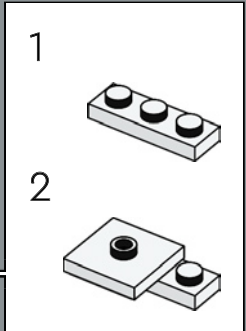
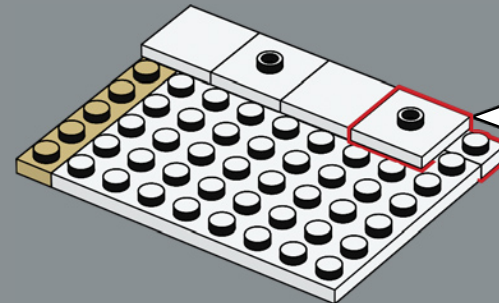

7

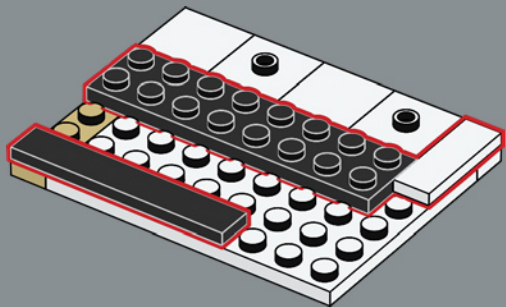

8

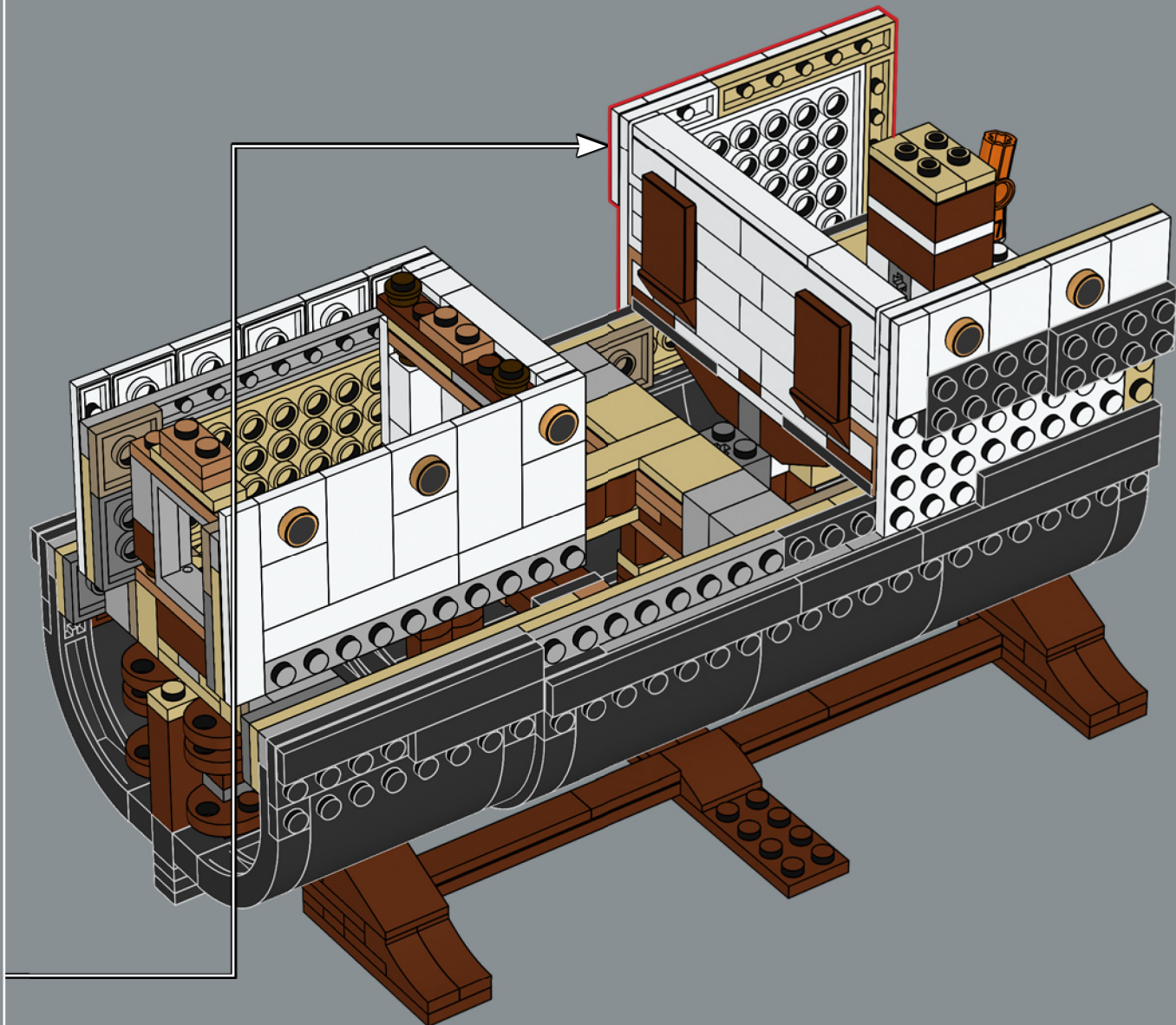
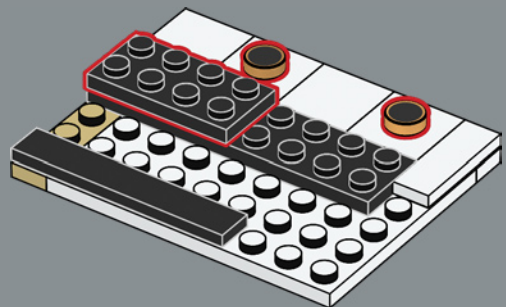

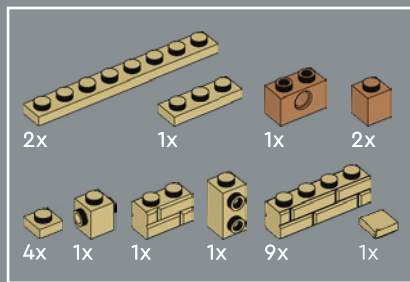
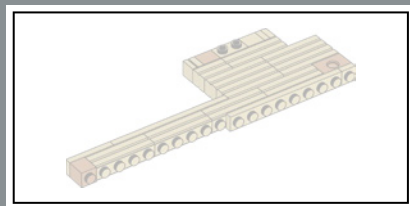

251

1

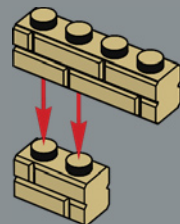

2

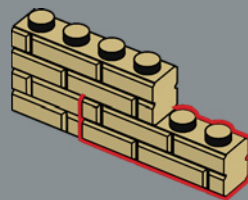

3

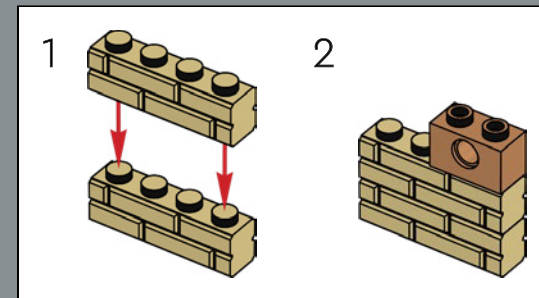
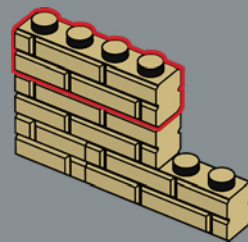

4

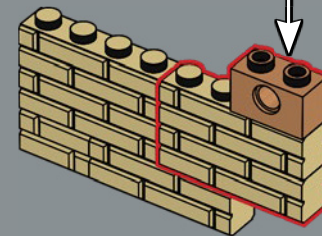

5

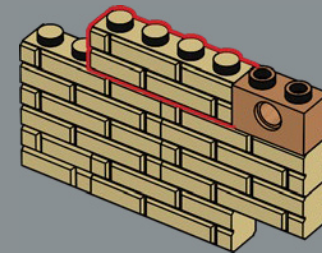

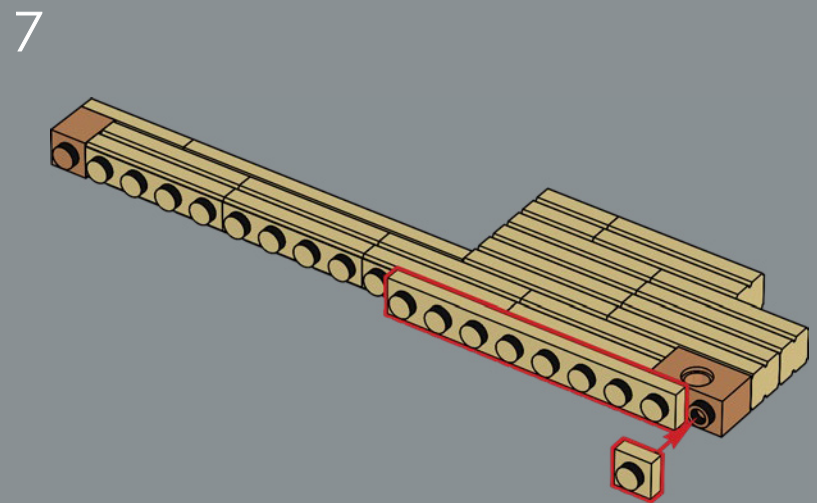
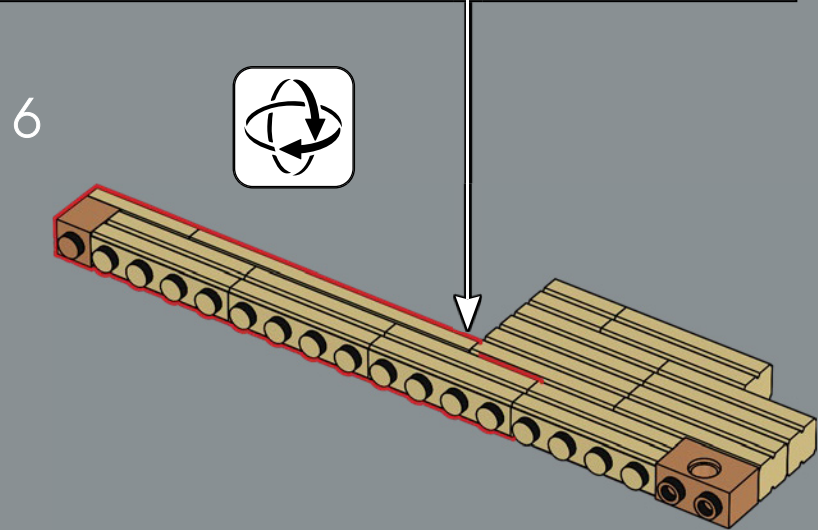
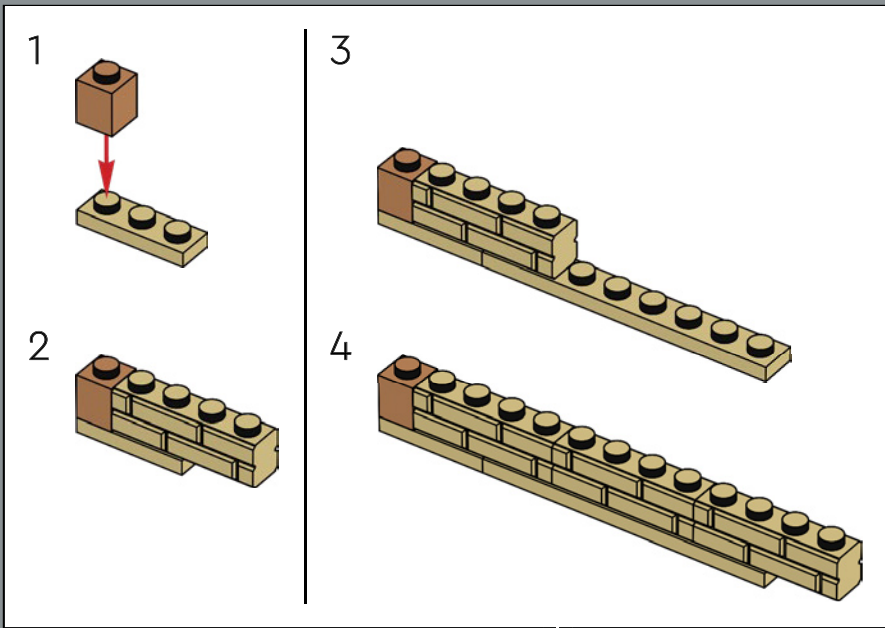

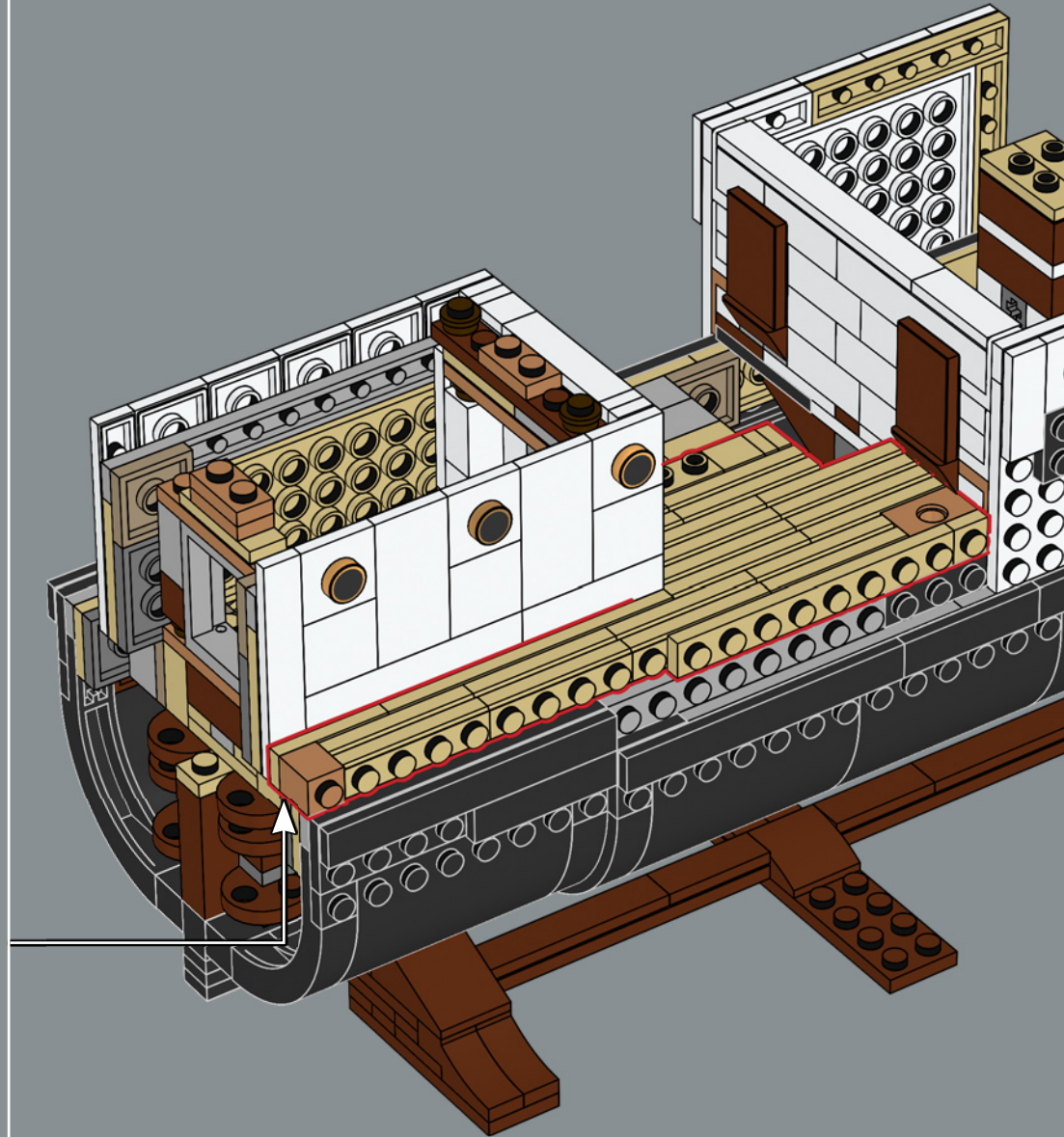
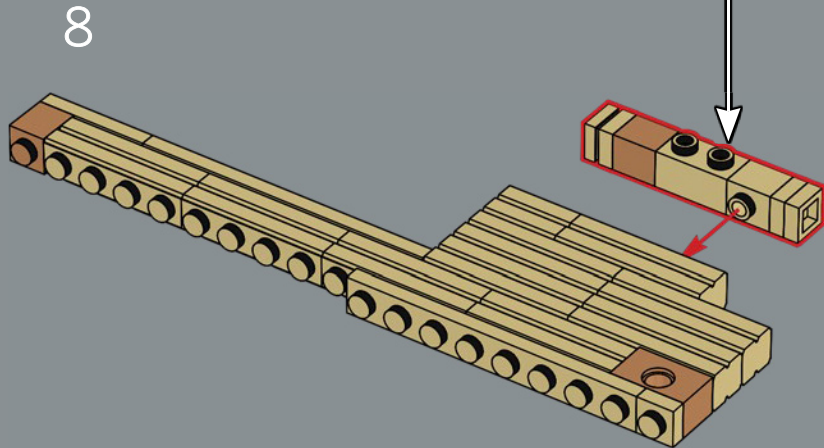
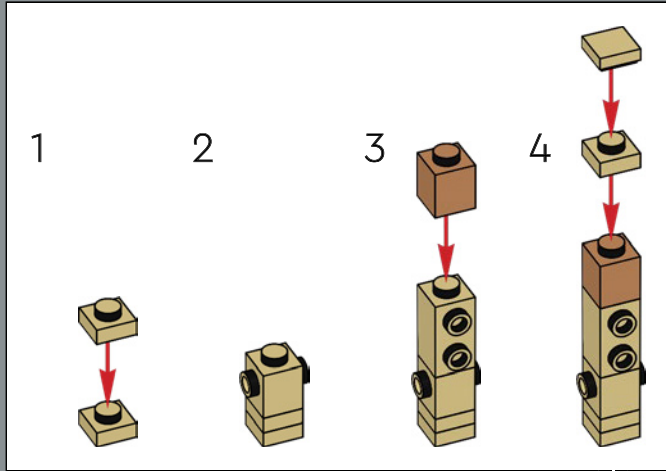

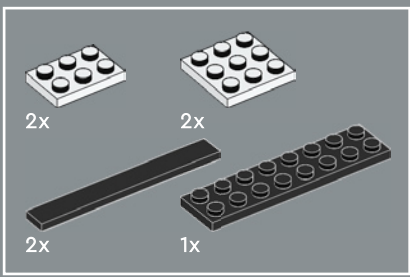

252

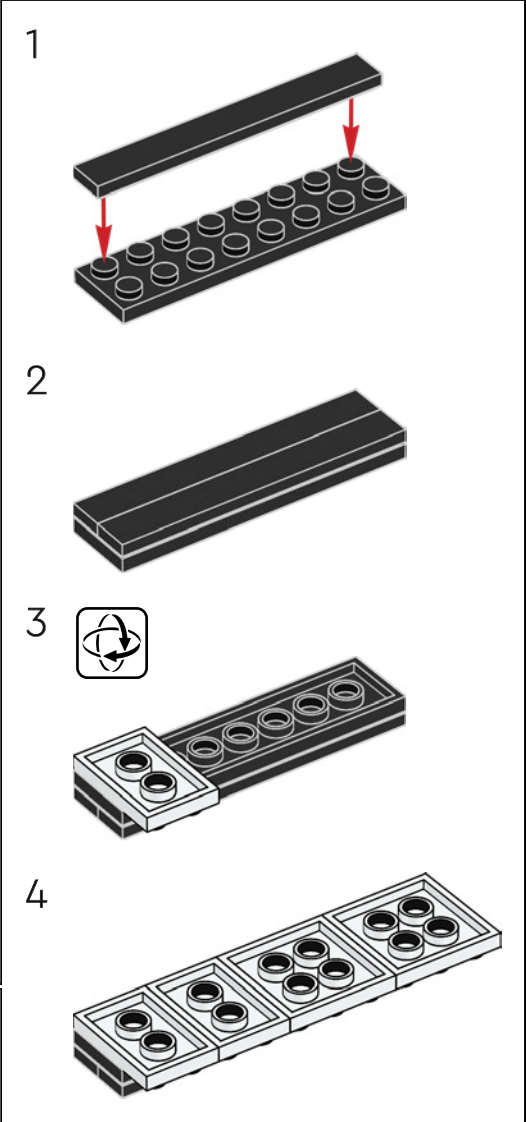
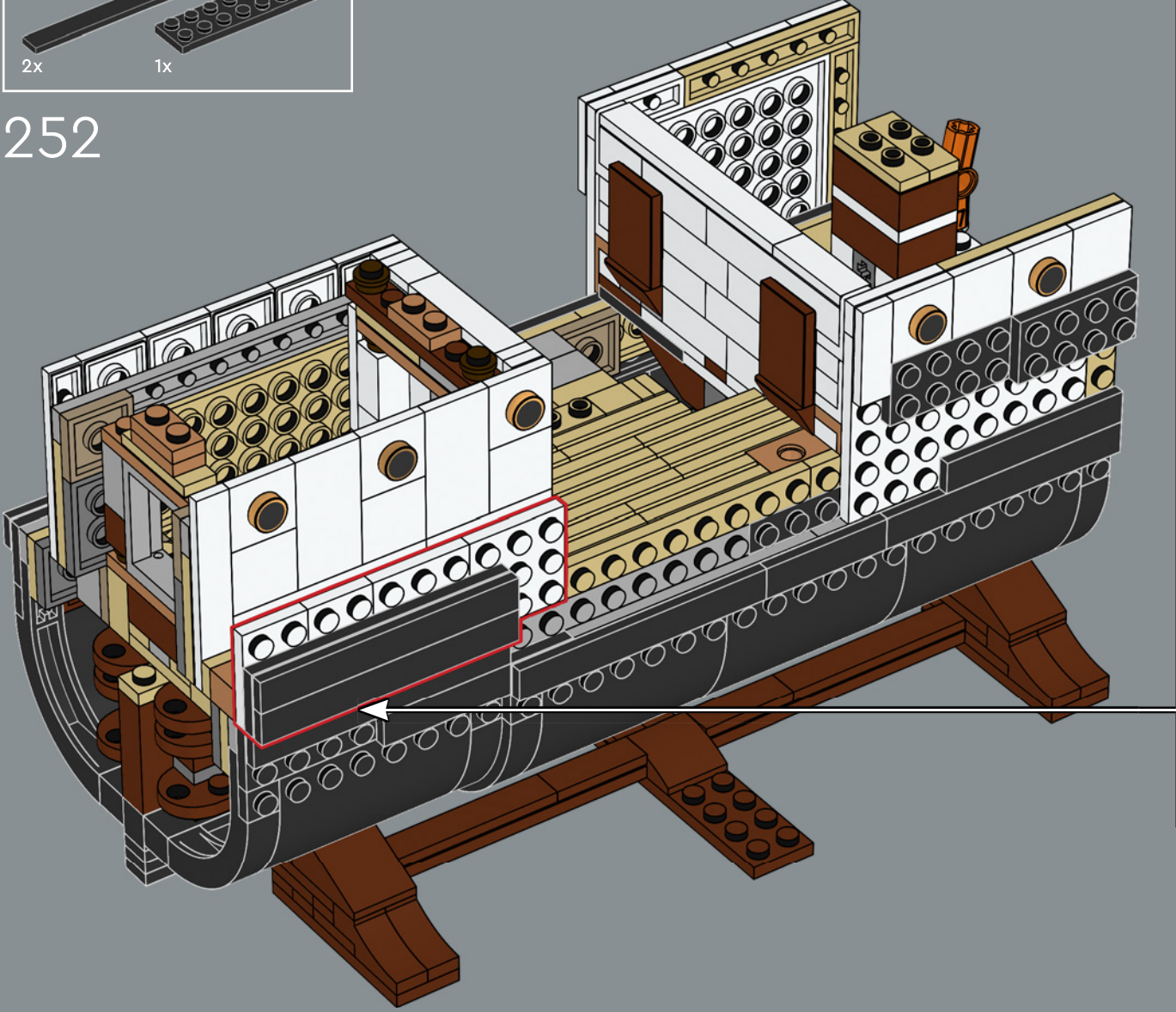

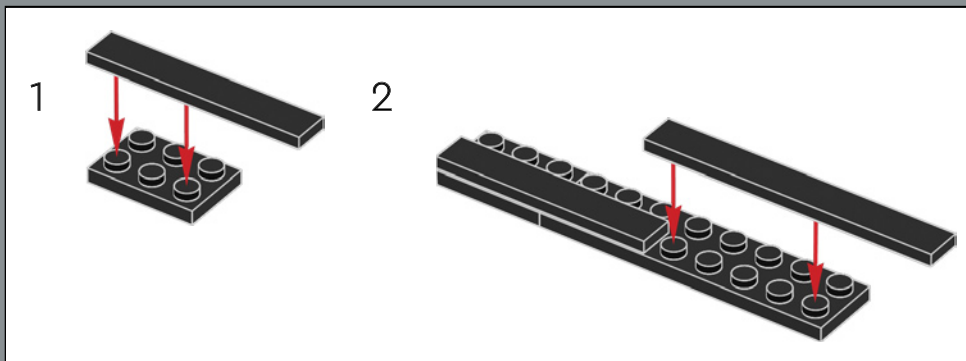
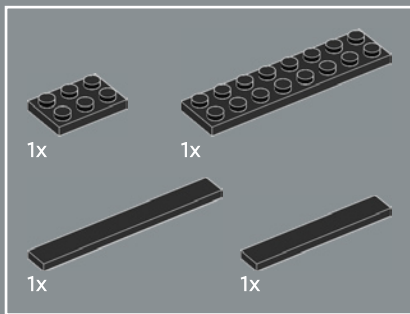

253

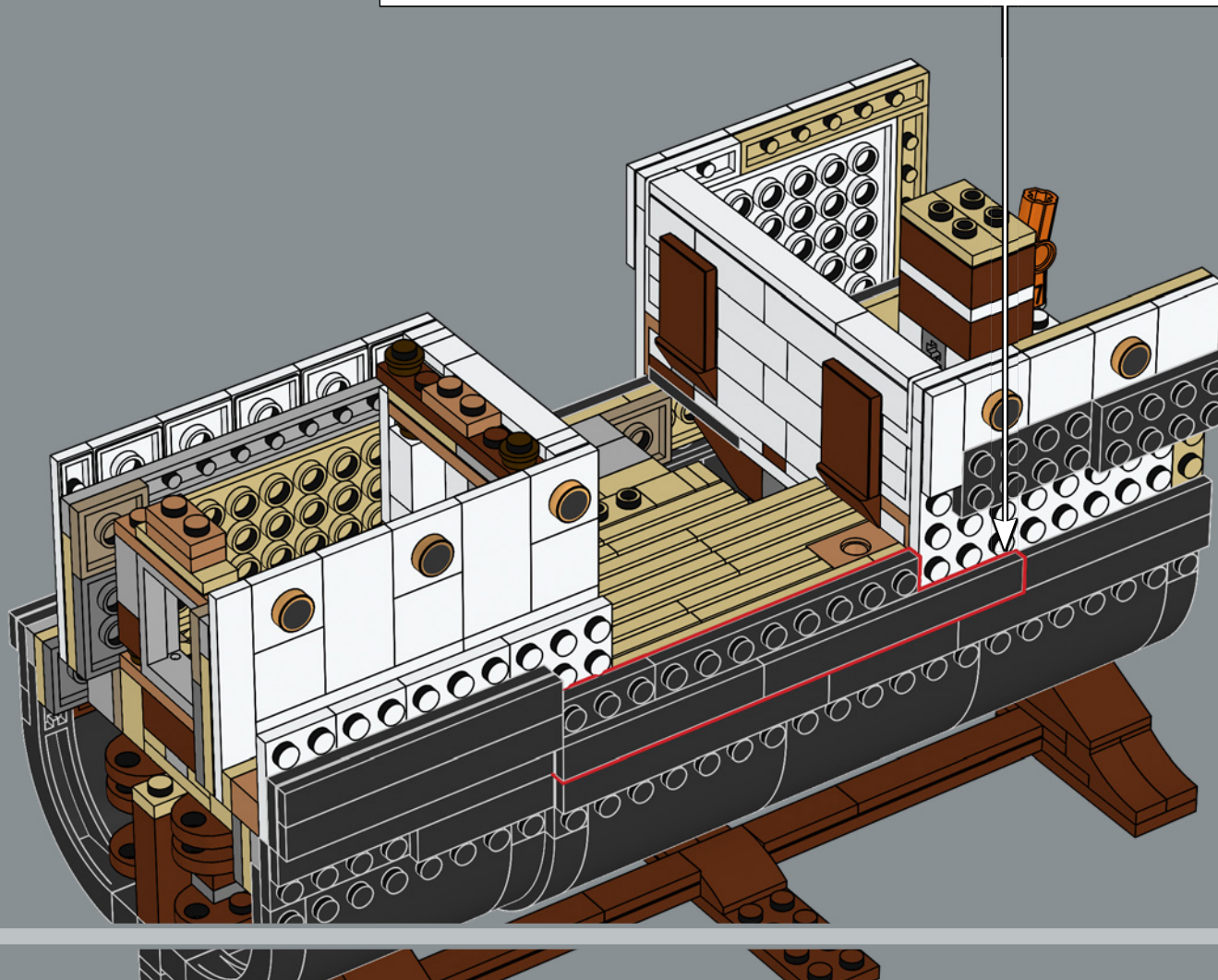

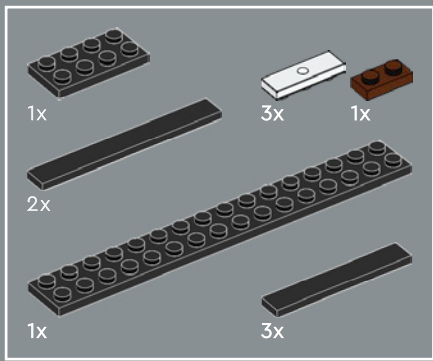

254

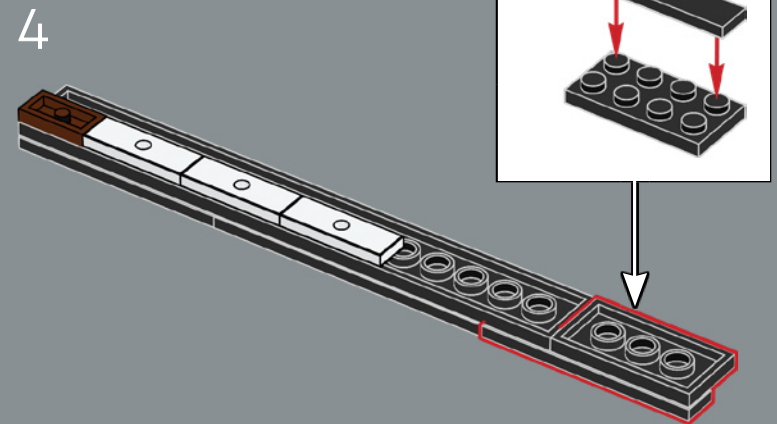
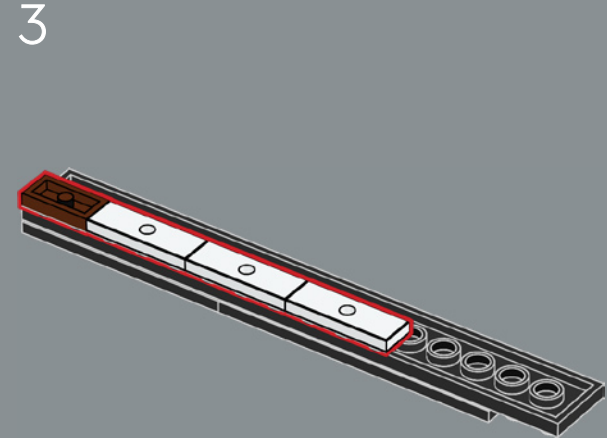
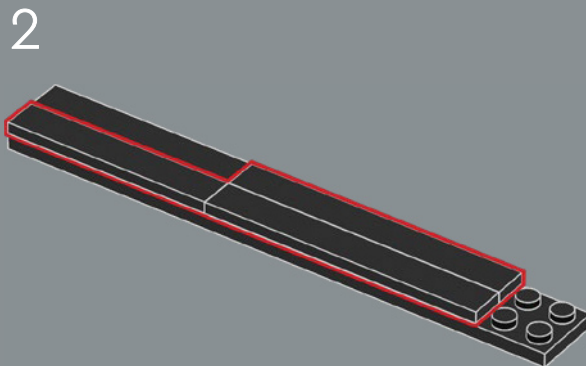
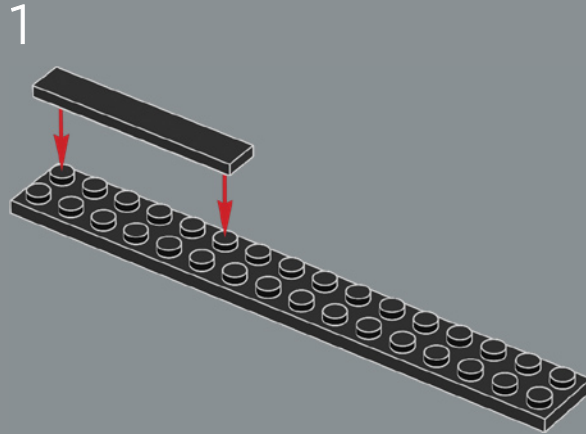

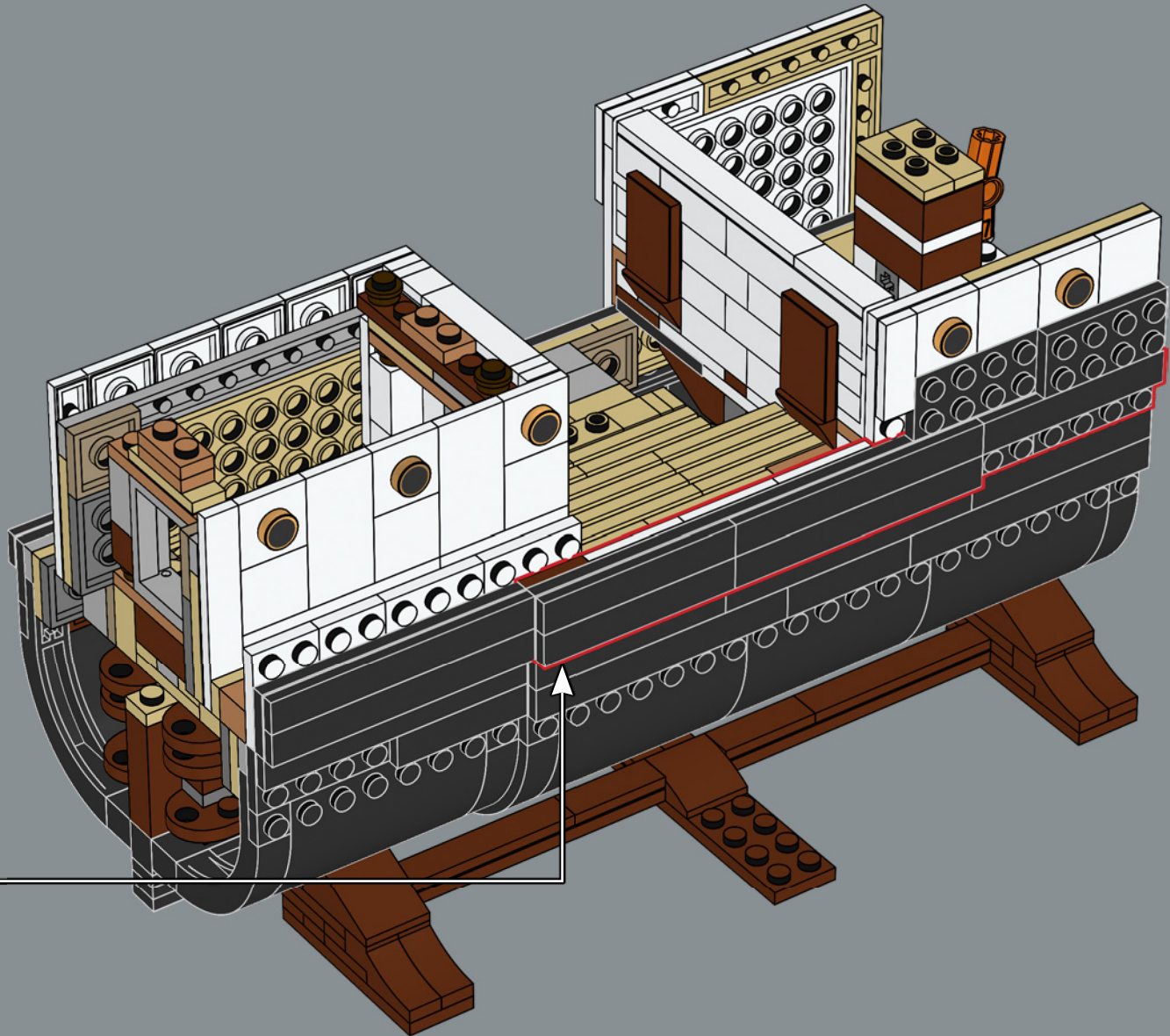

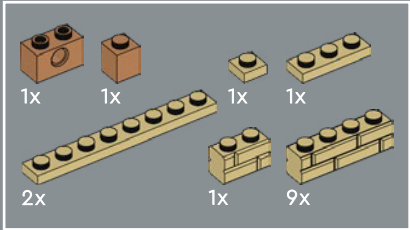
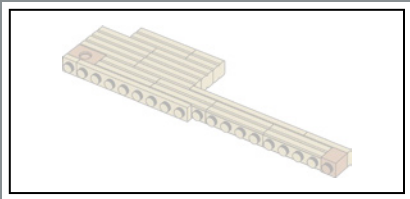

255

1

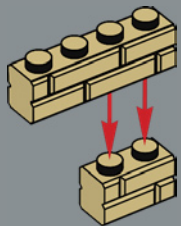

2

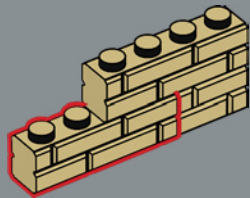

3

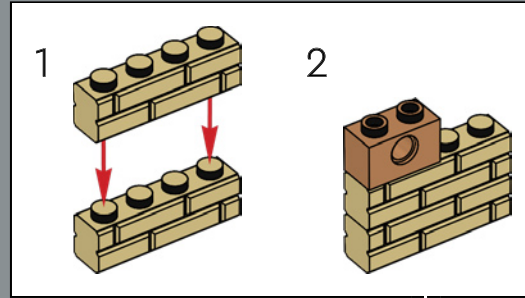
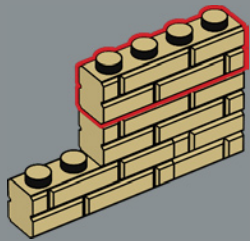

4

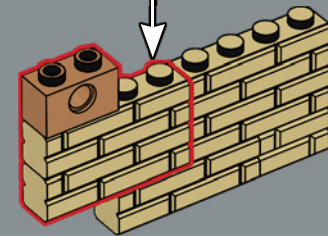

5

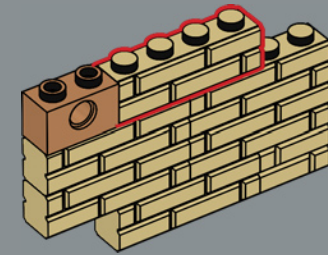

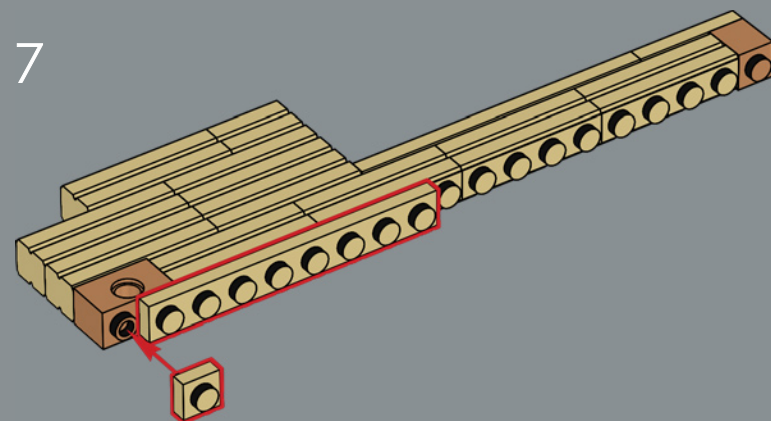
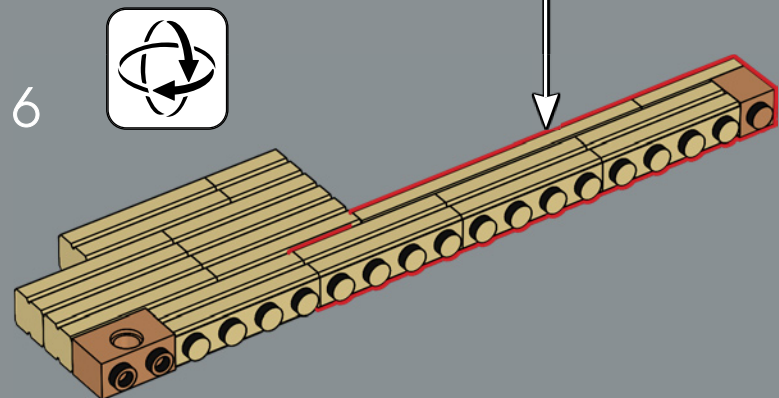
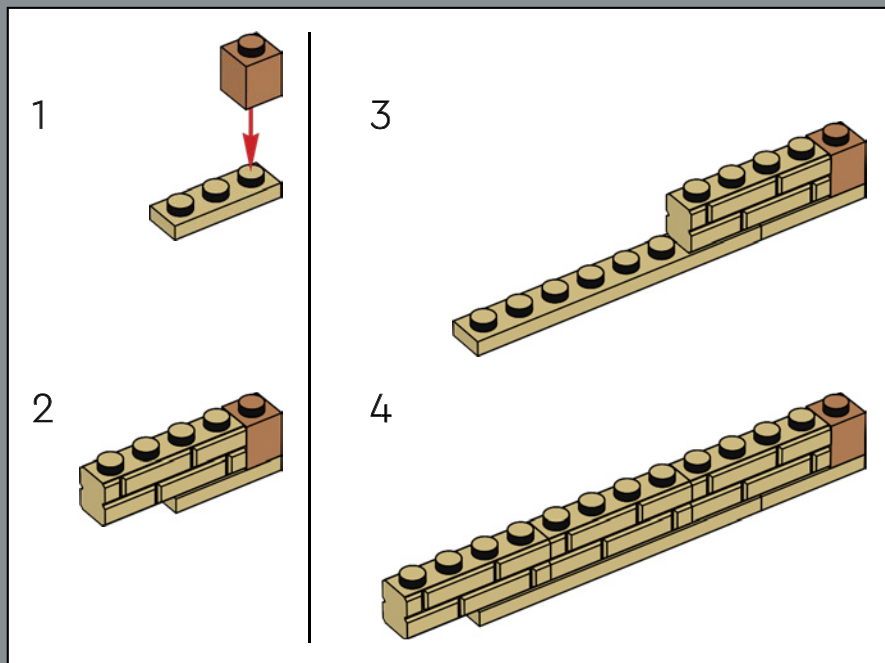

Para dar a la cubierta inferior la apariencia de estar hecha de tabloncillos de madera, se utilizaron ladrillos LEGO® comúnmente usados para representar paredes de ladrillo con la cara posterior visible.

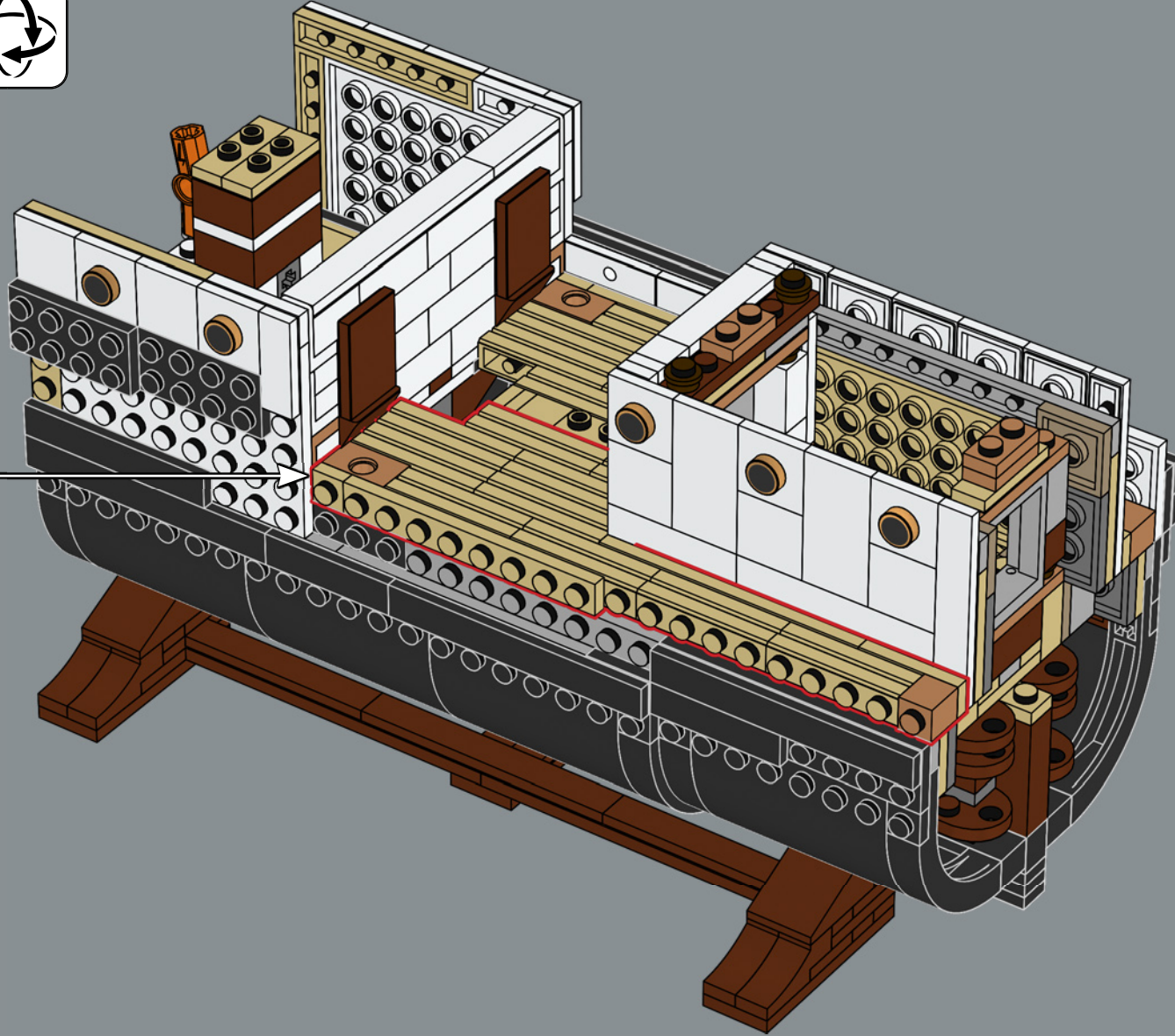

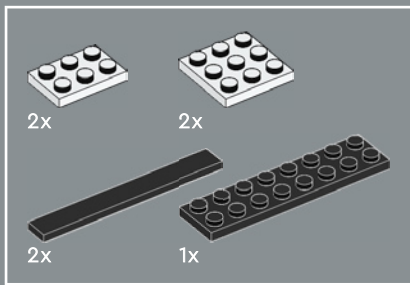

256

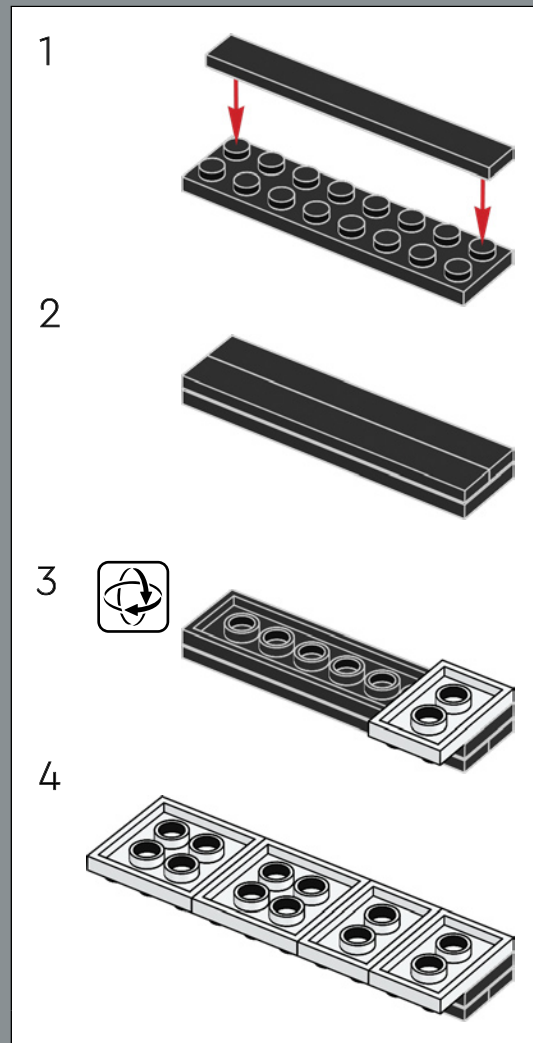
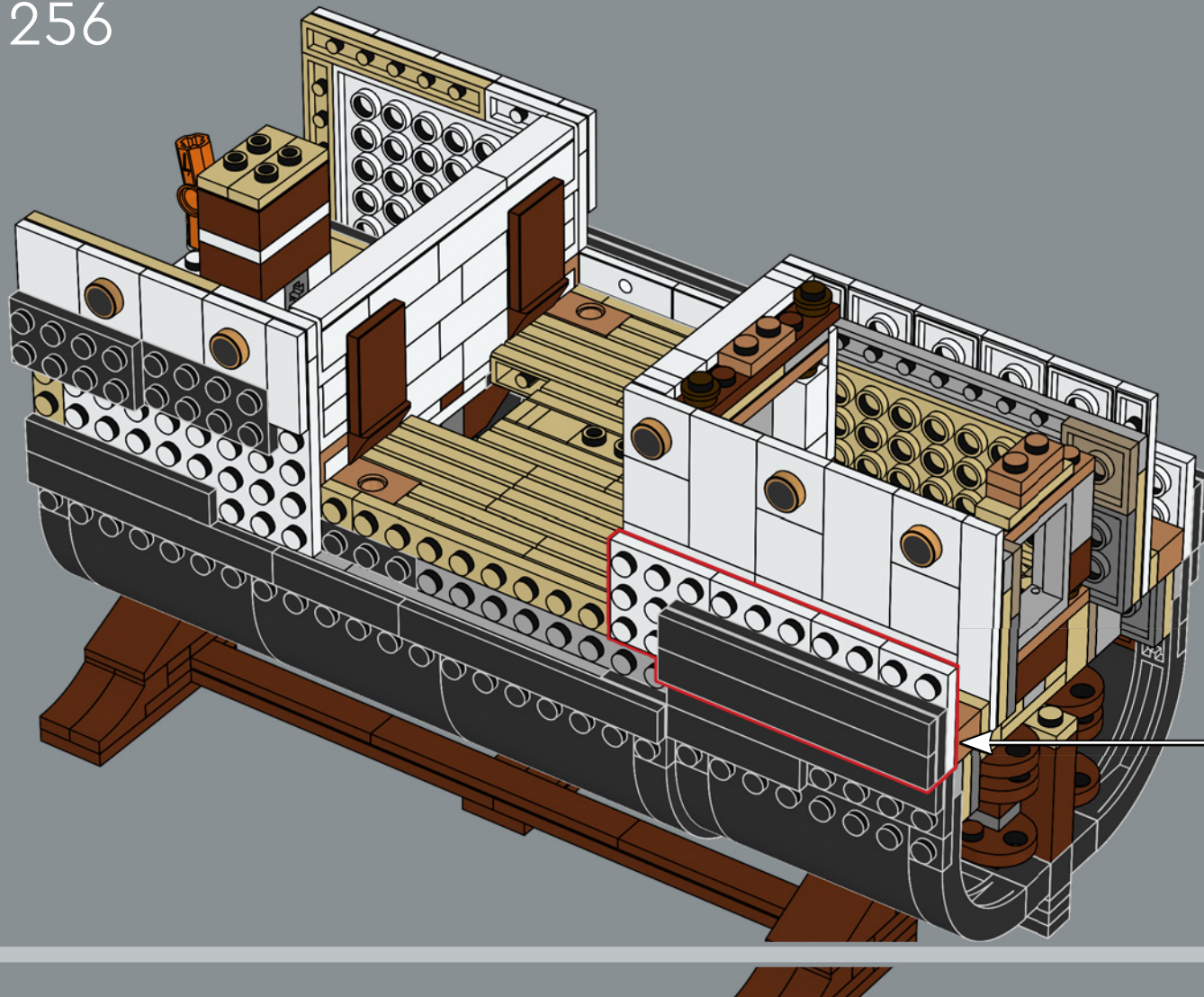

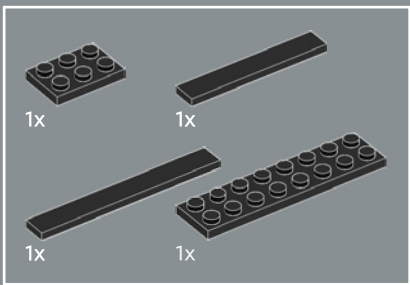

257

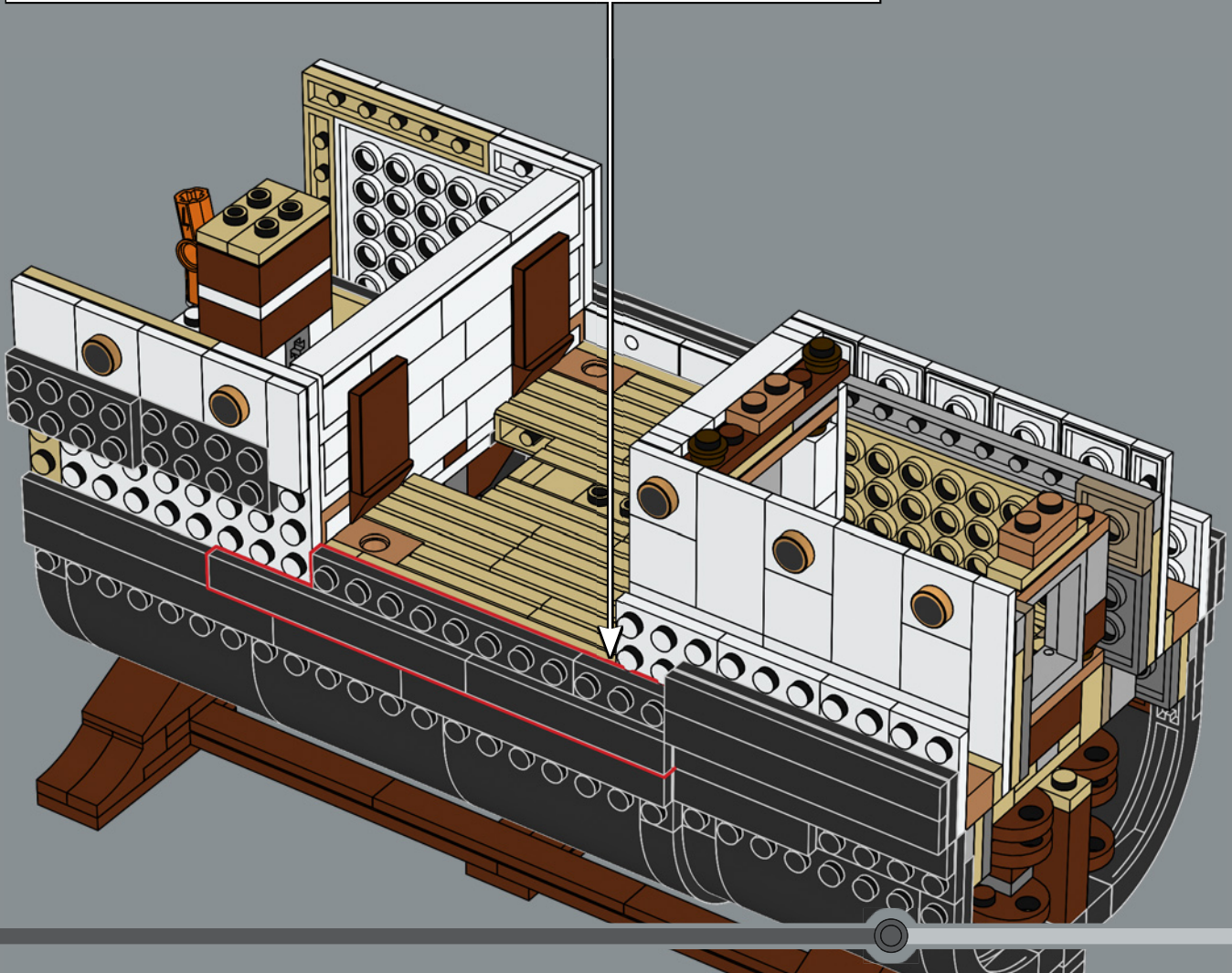
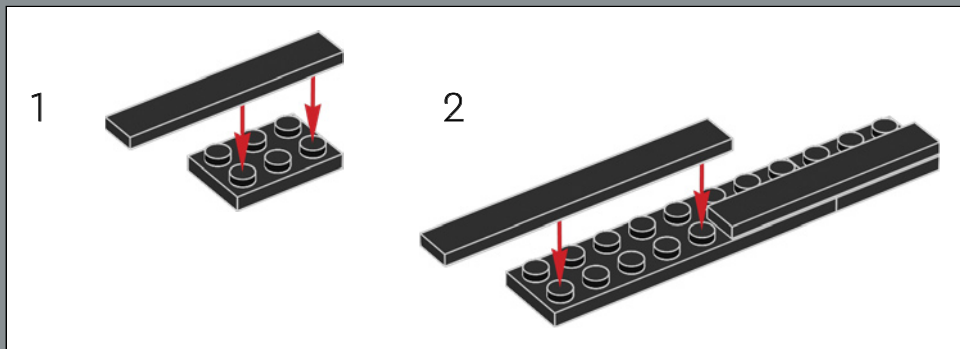

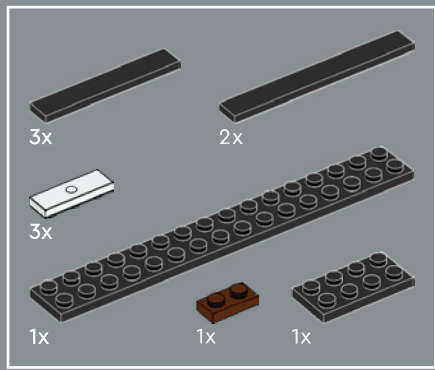

258

1

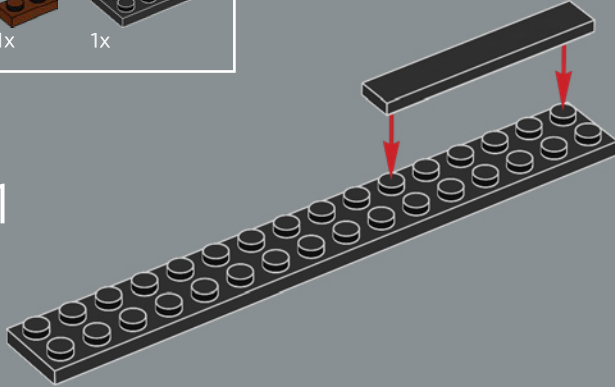

2

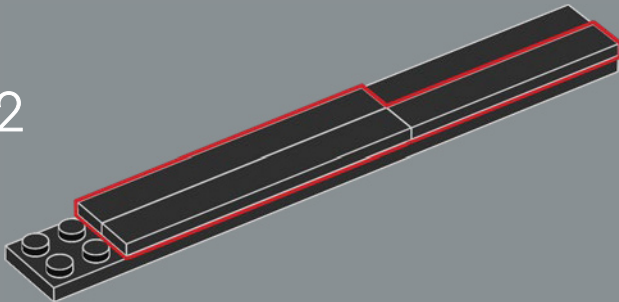

3

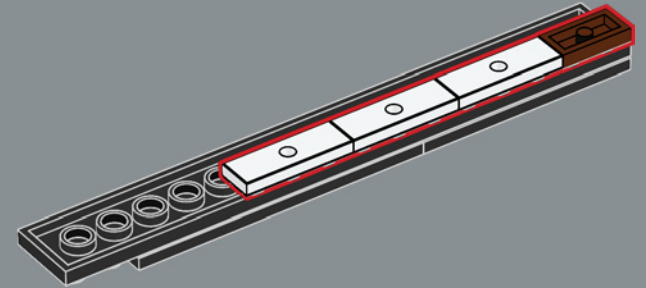

4

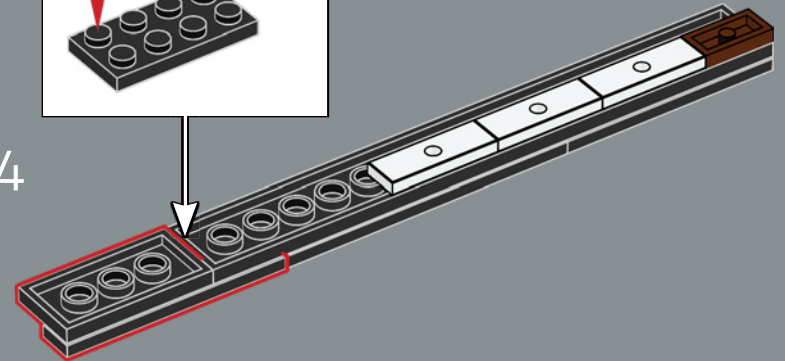
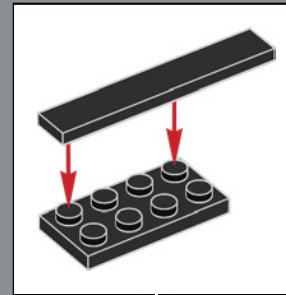

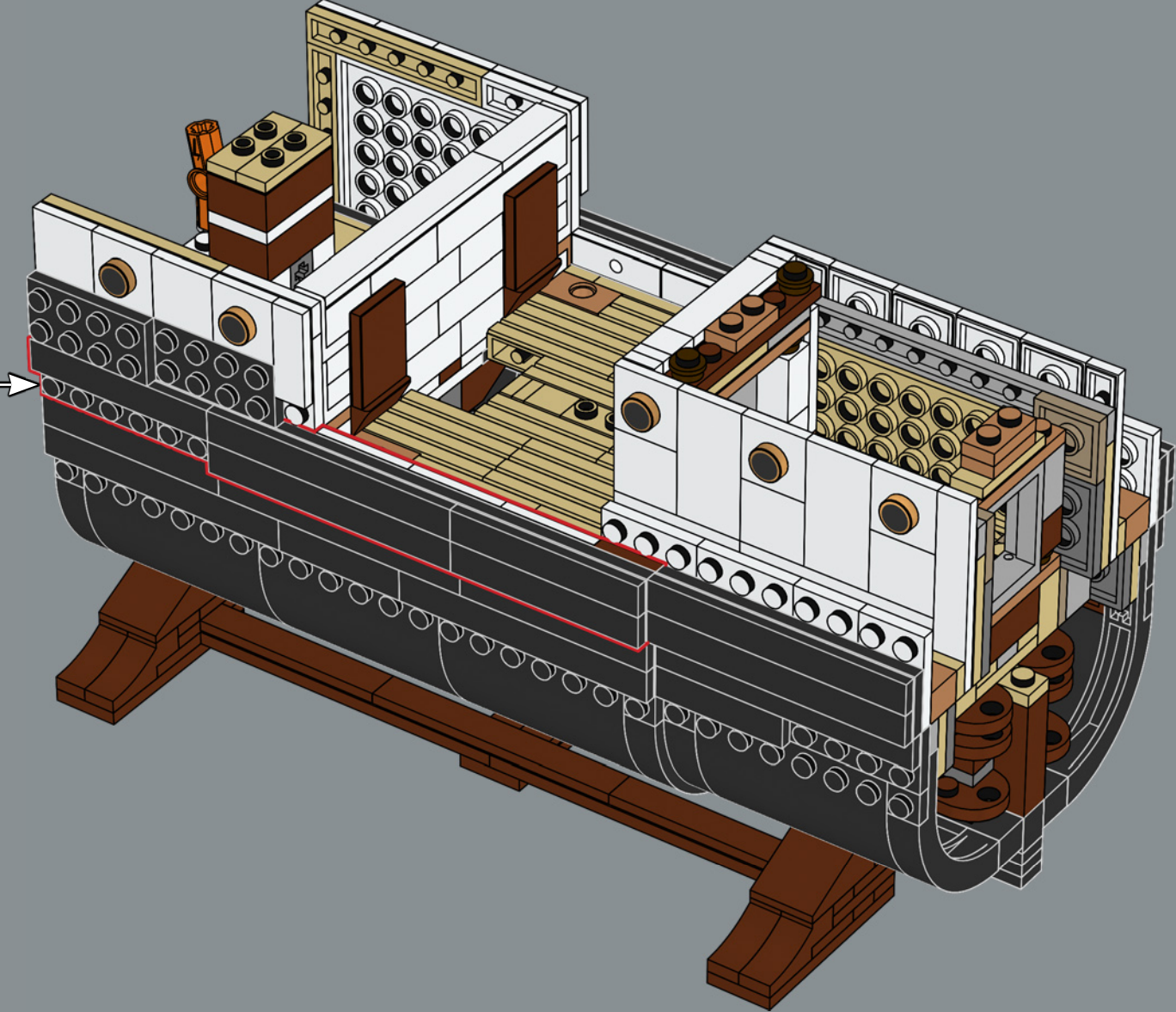

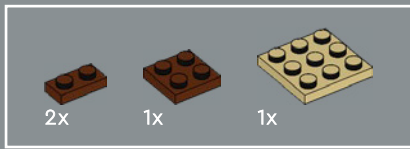

259

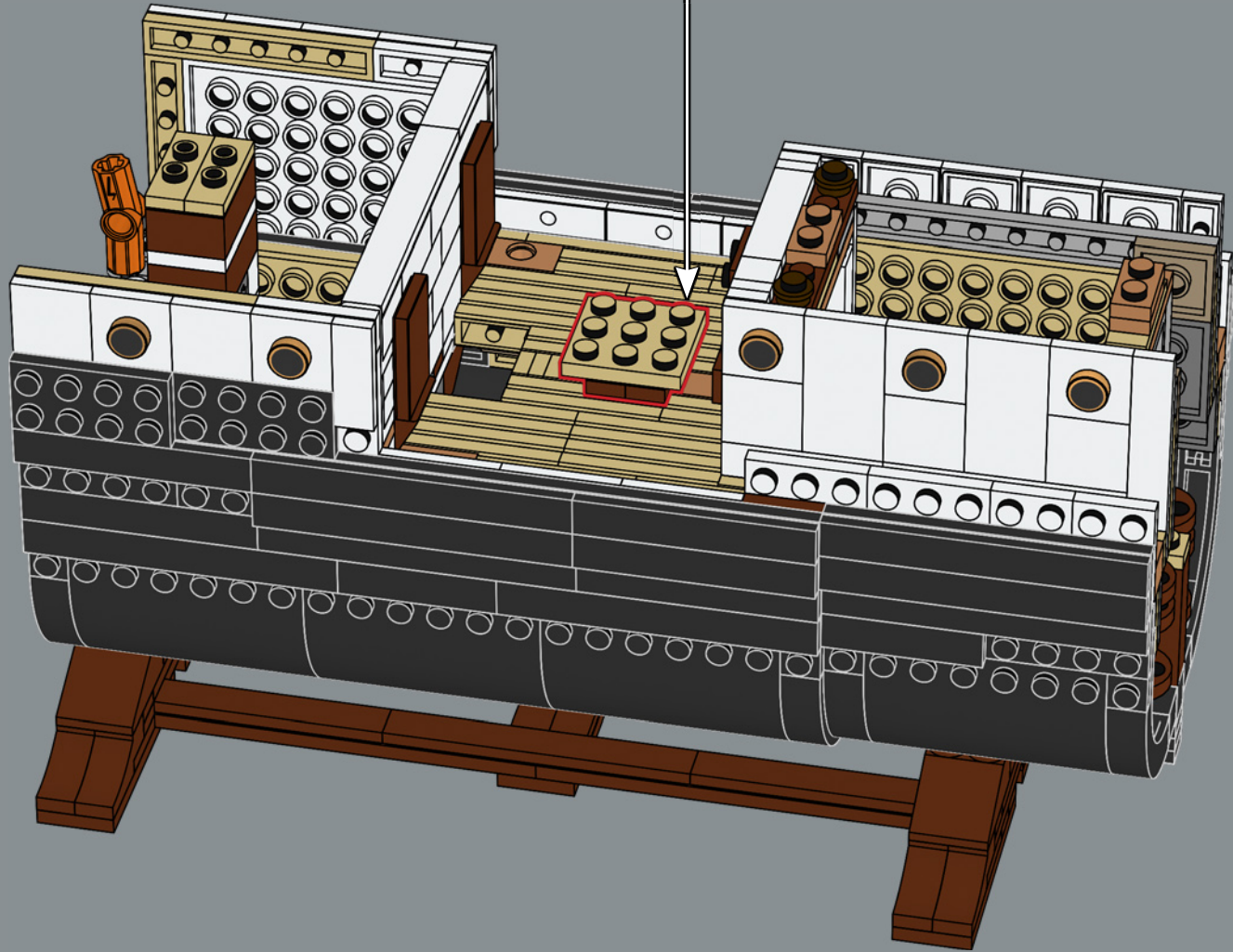
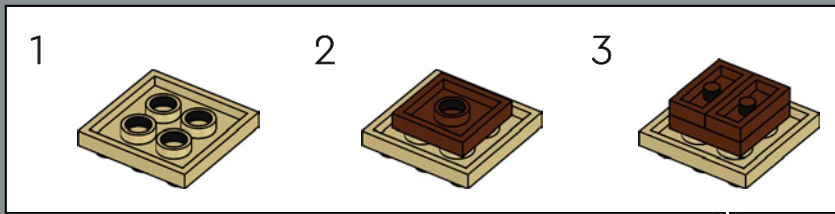

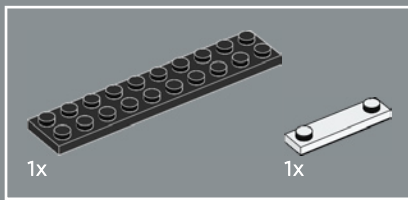
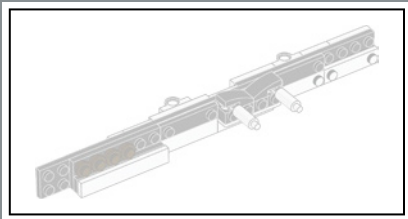

260

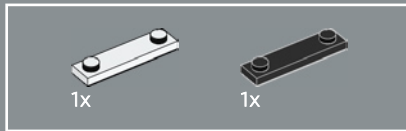
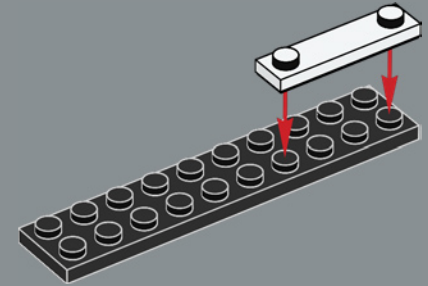

261

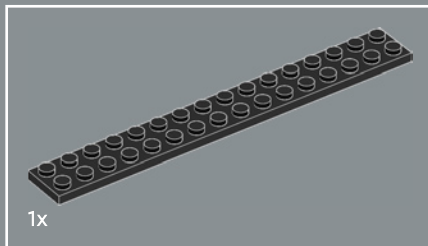
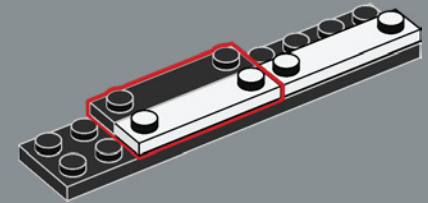

262

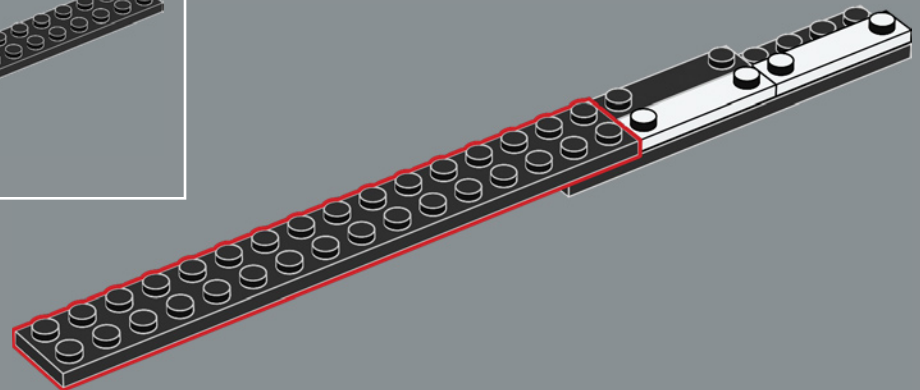

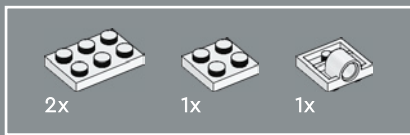

263

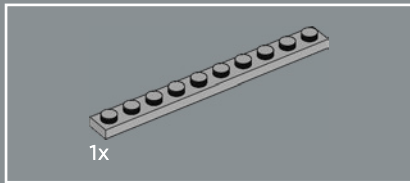
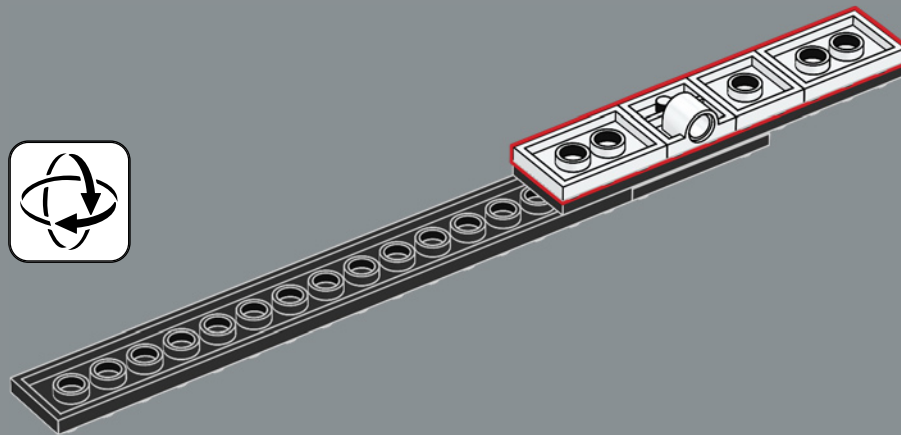

264

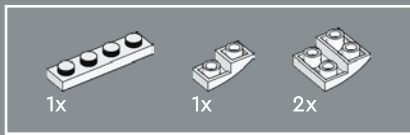
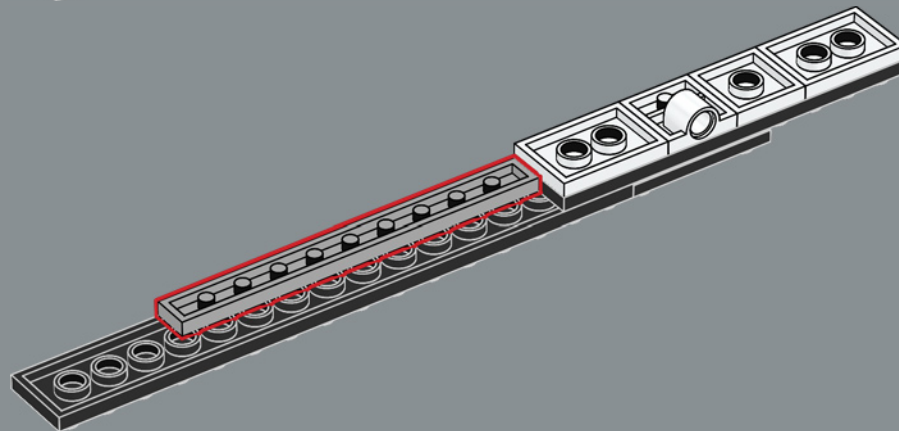

265

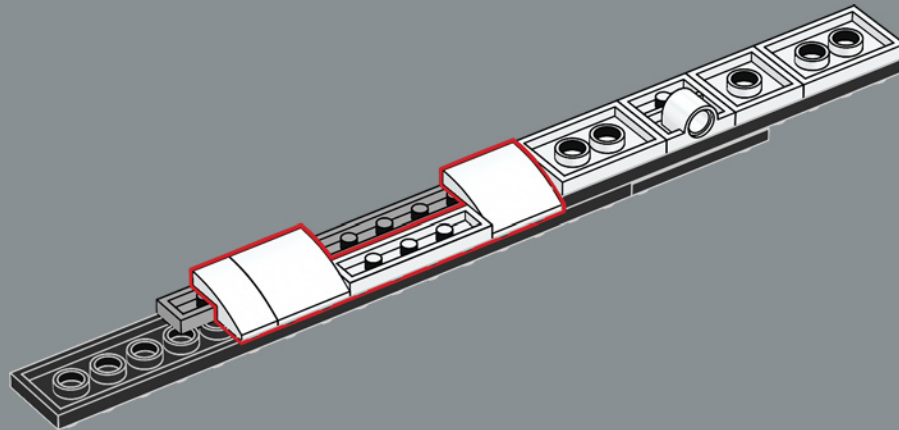



266

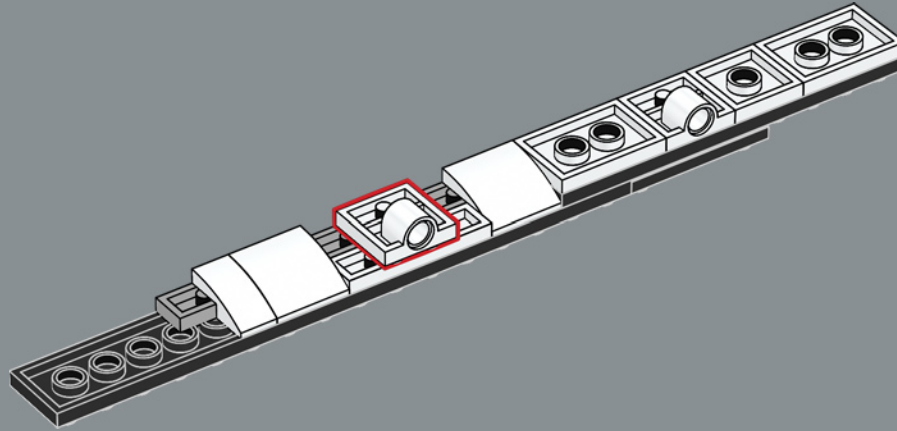

267

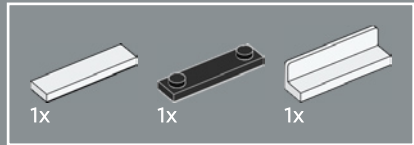
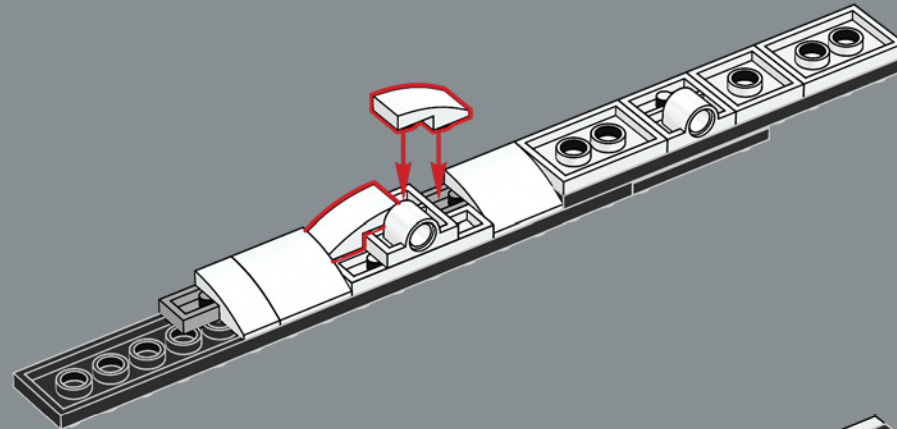

268

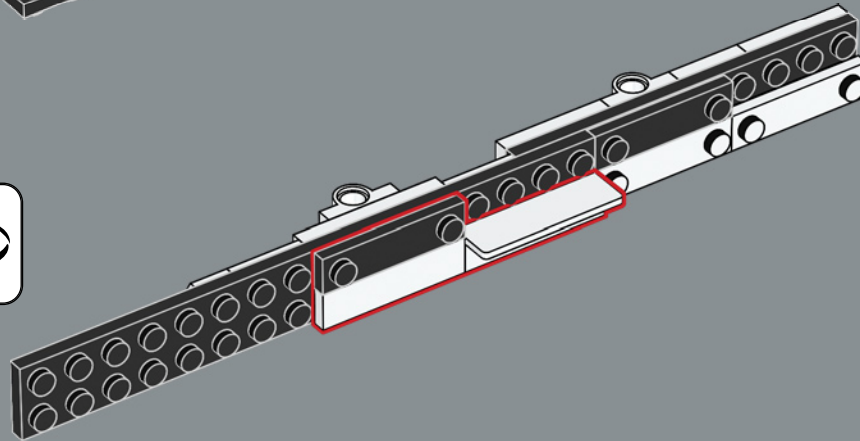

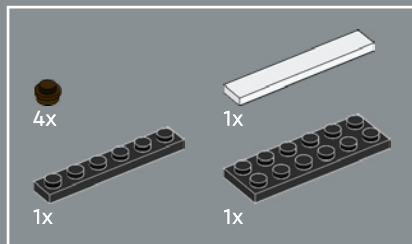

269

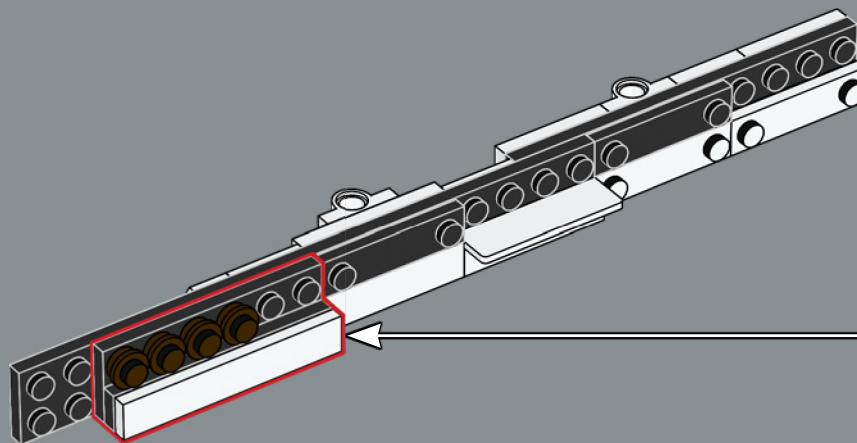
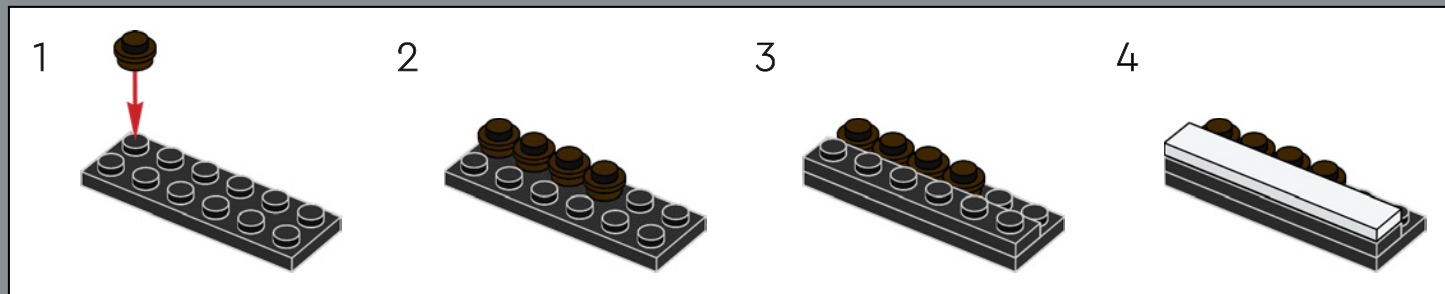



4x

270

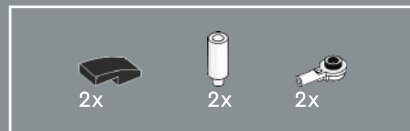
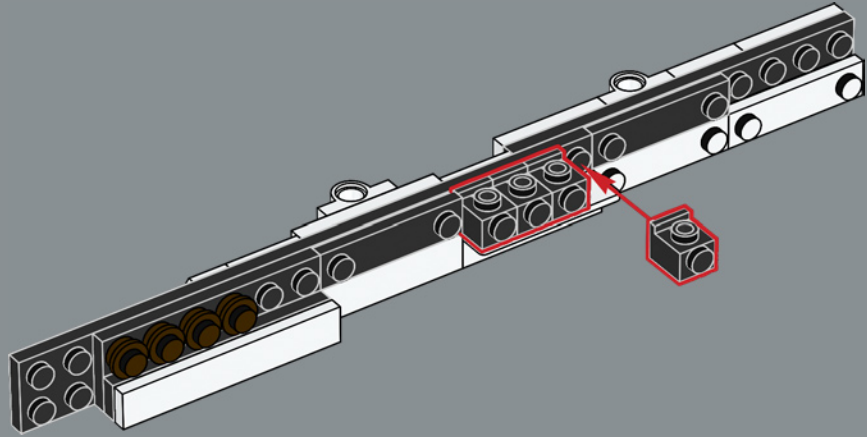

271

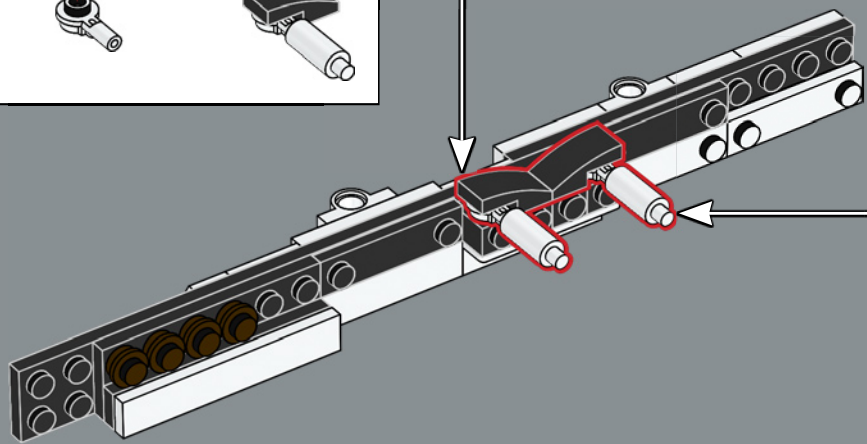
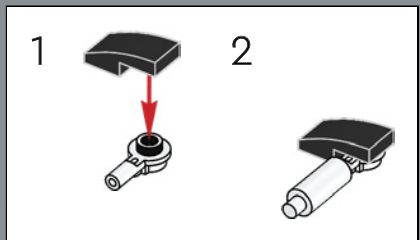
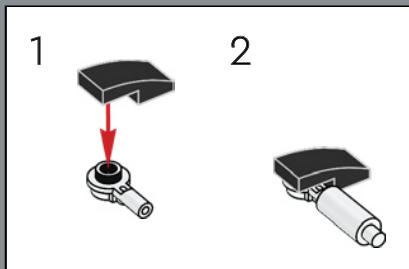

272

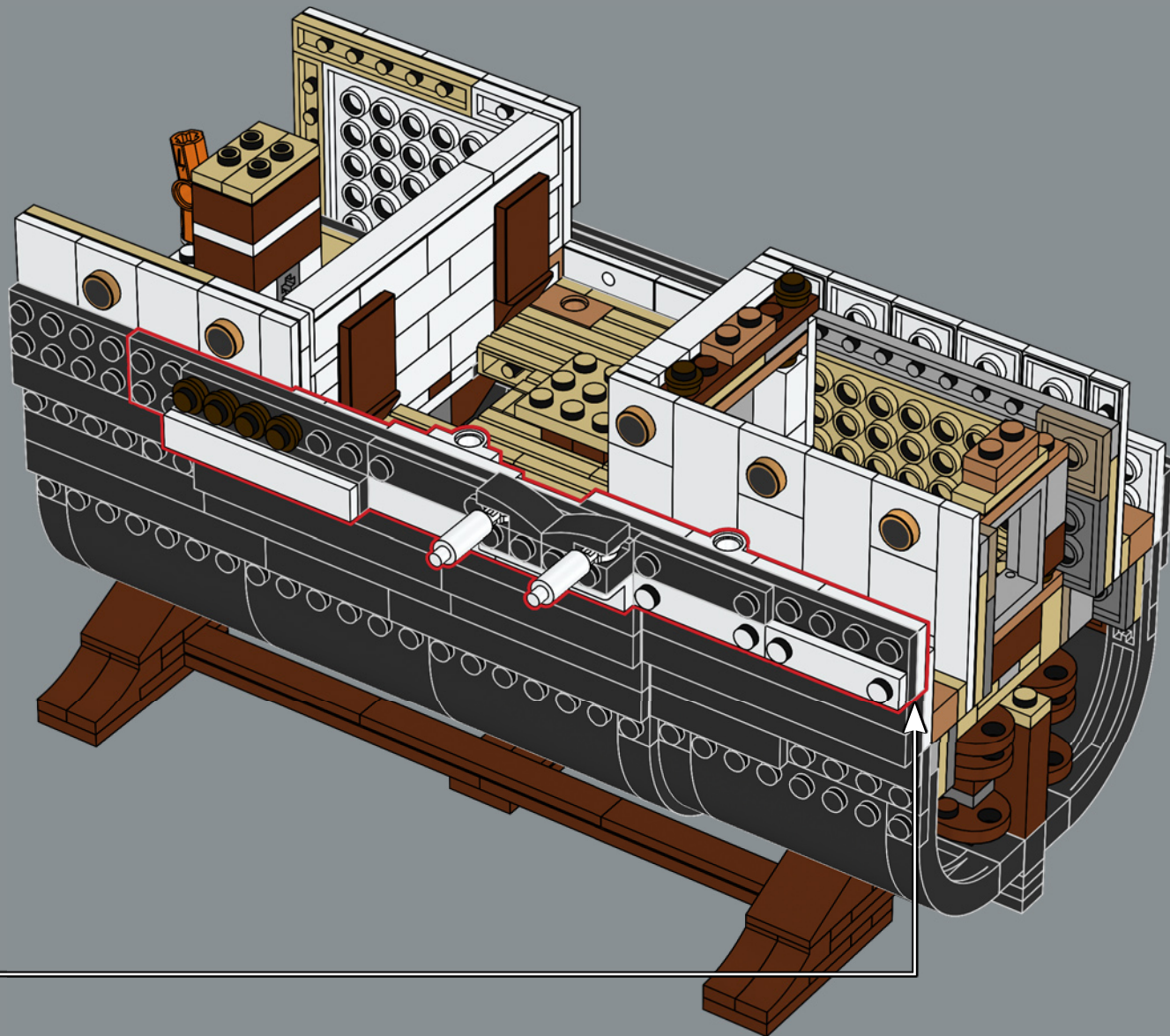

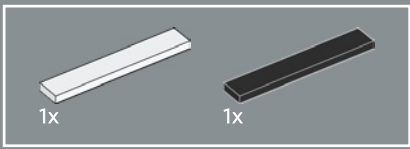

273

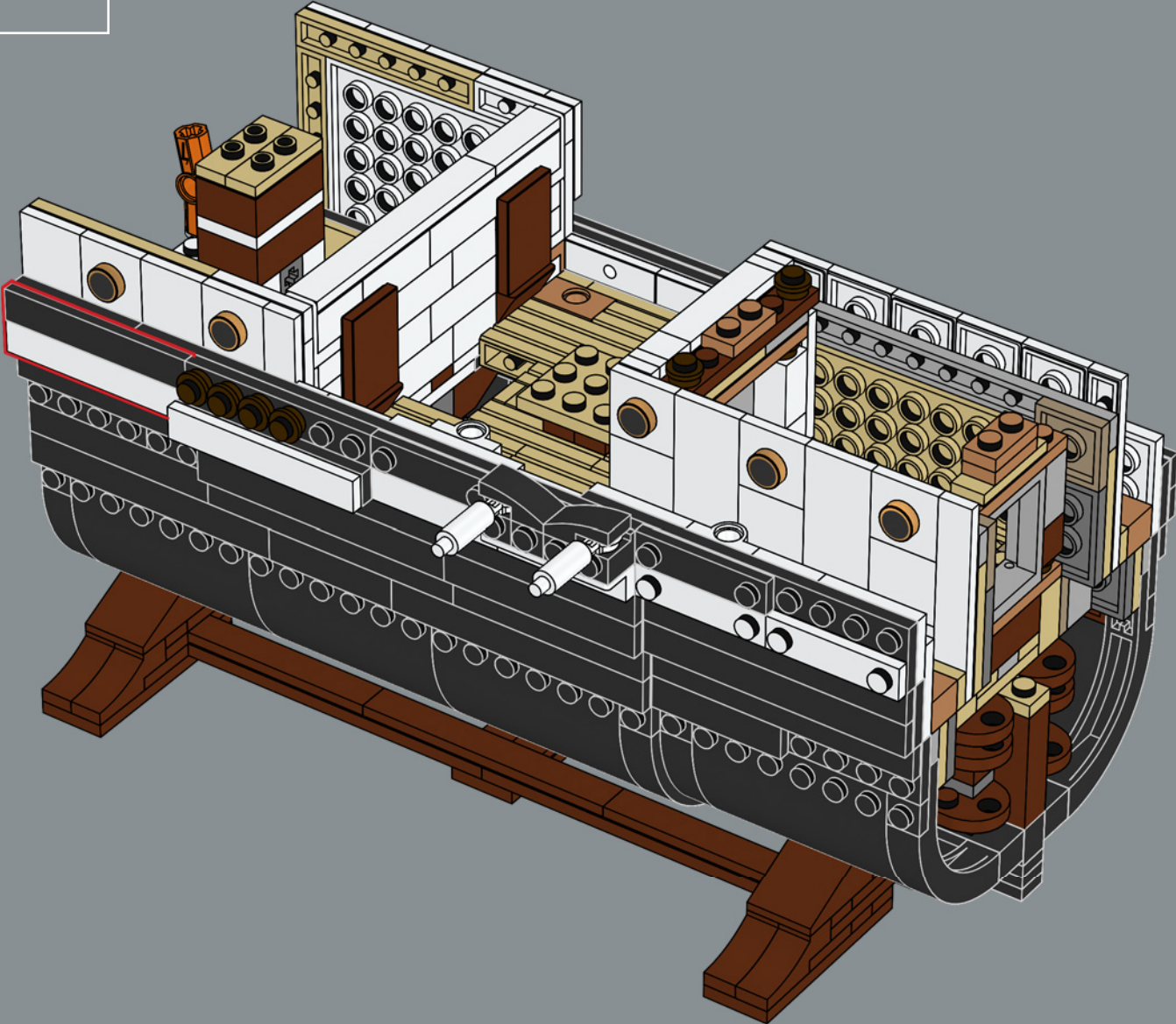

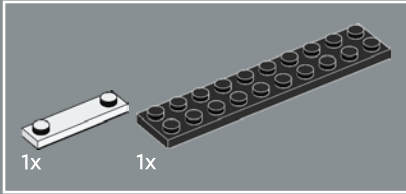
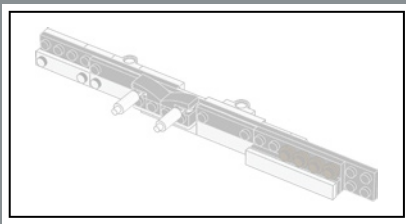

274

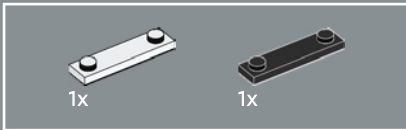
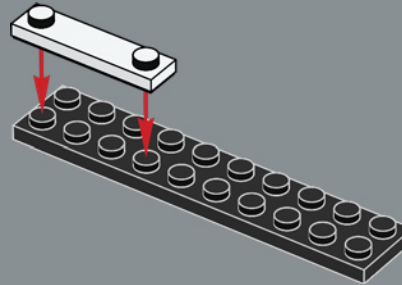

275

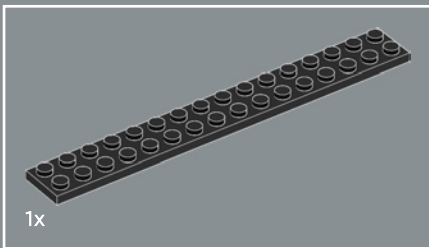
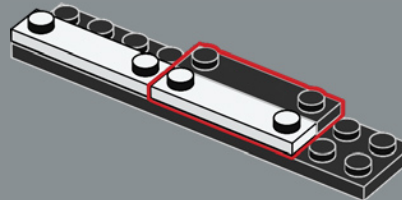

276

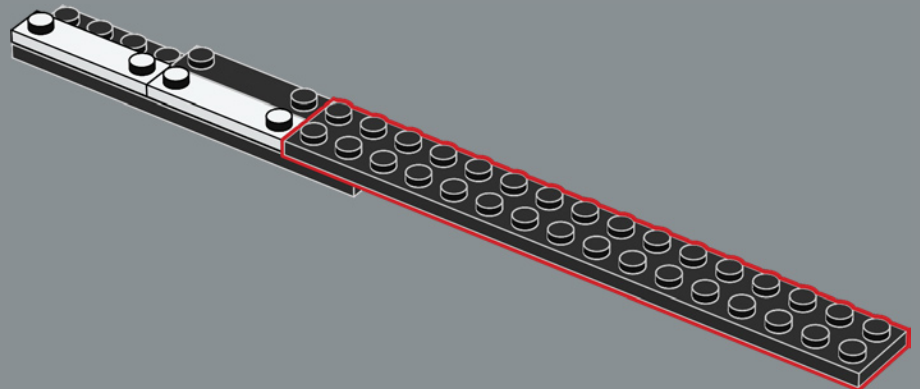

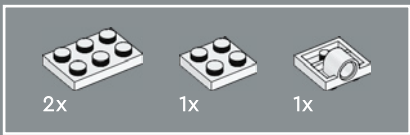

277

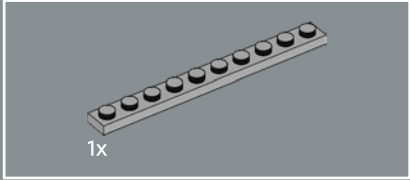
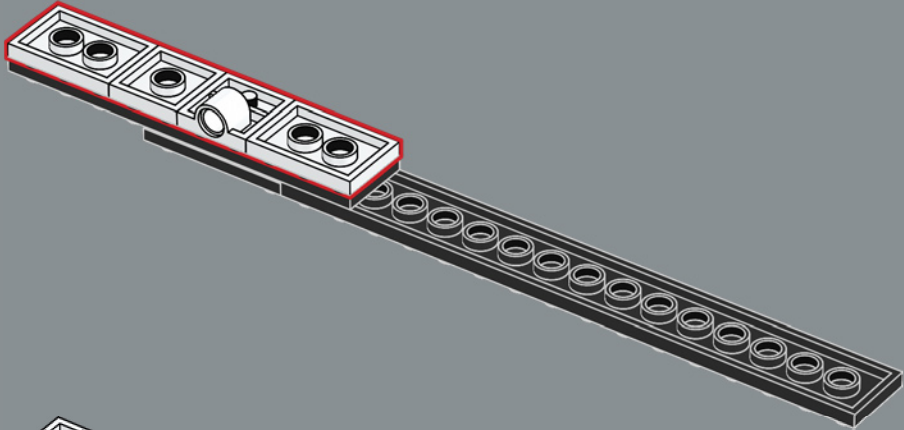

278

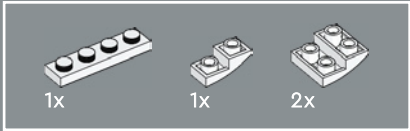
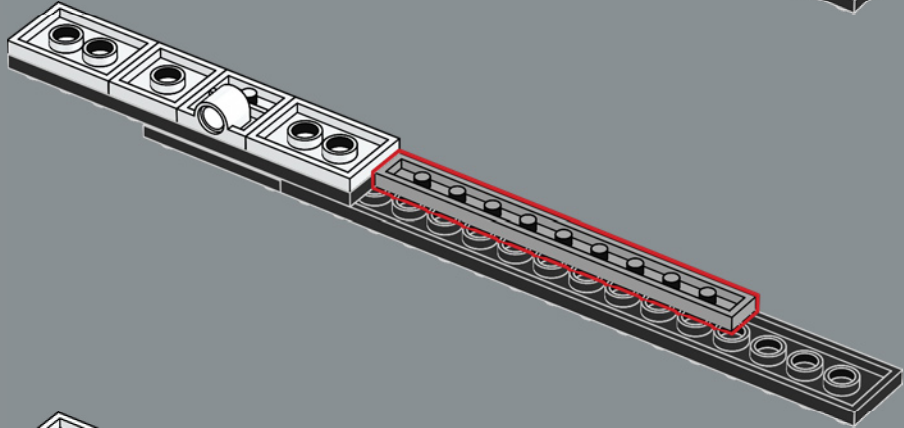

279

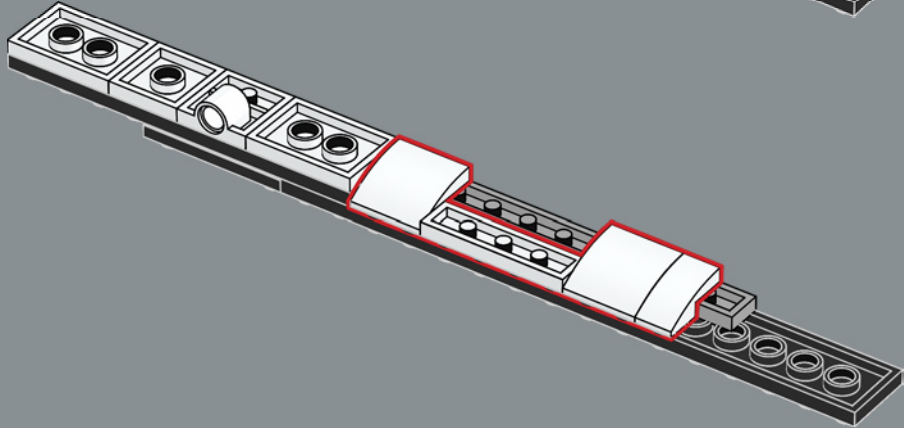



280



281

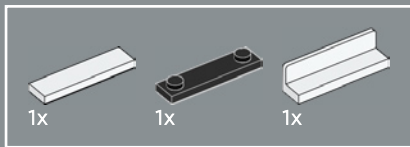

282

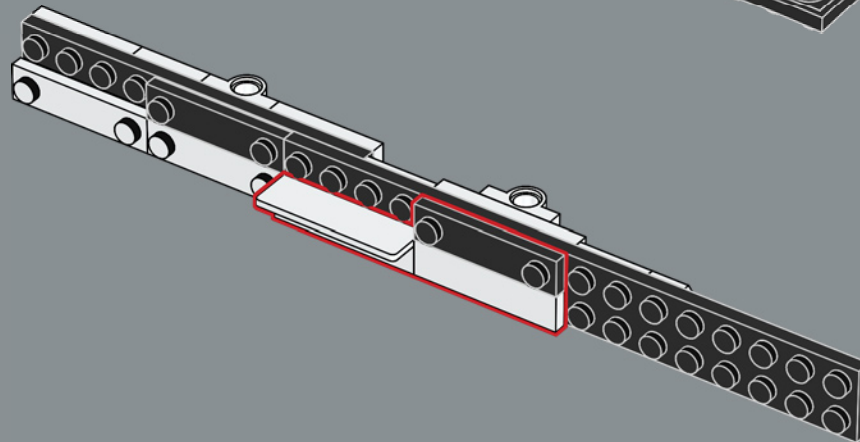
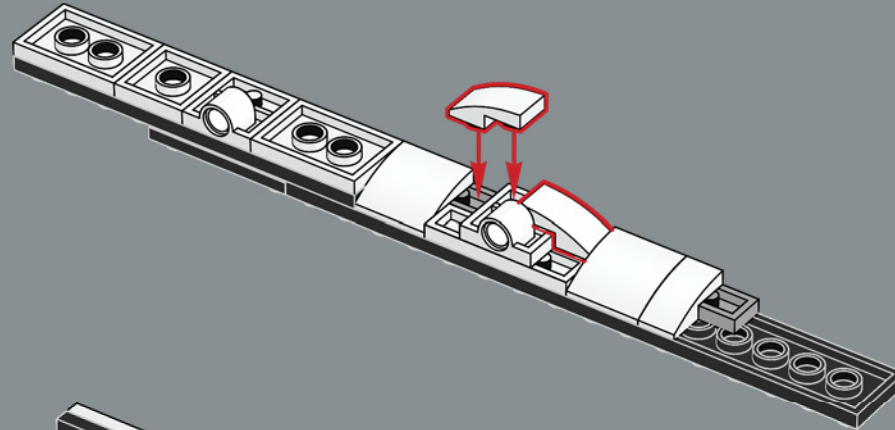
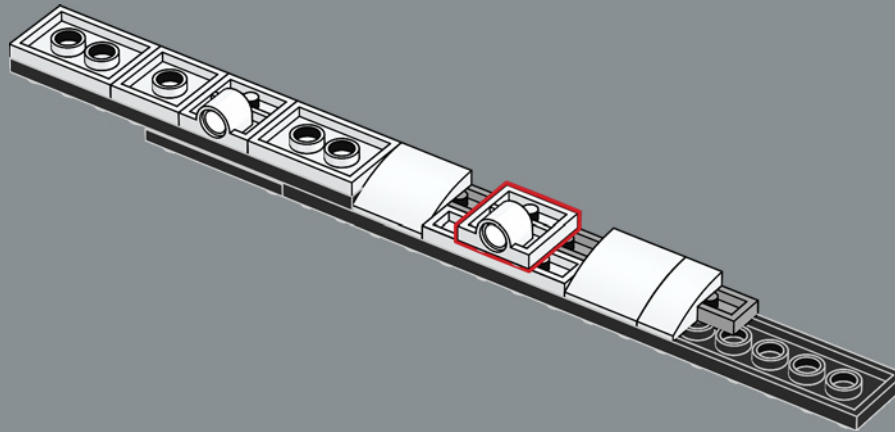

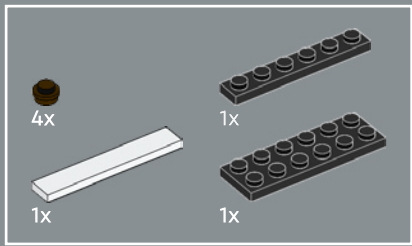

283

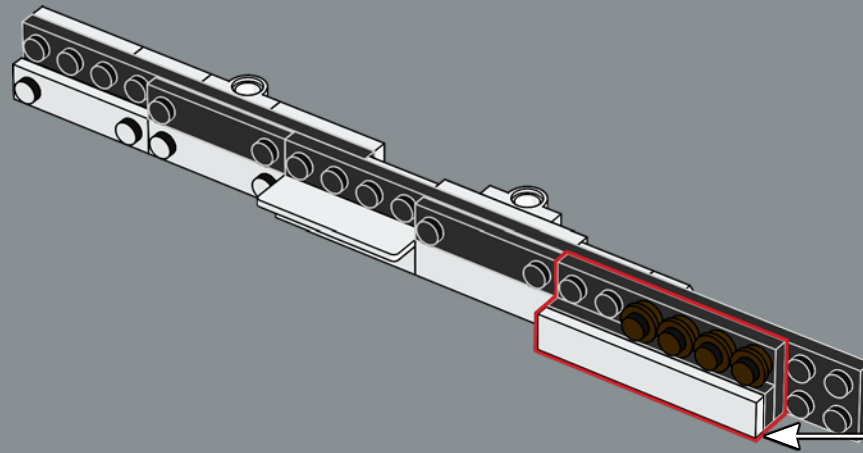
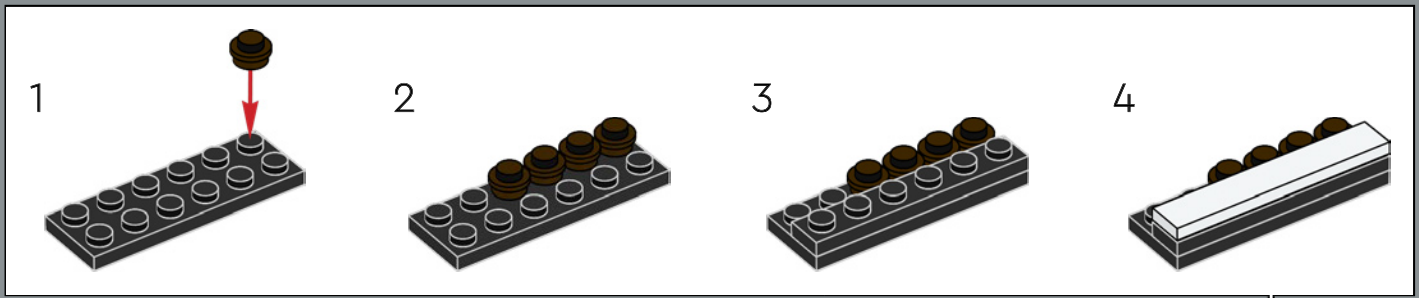



284

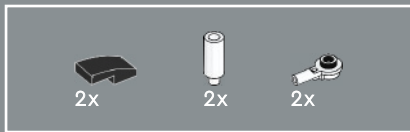
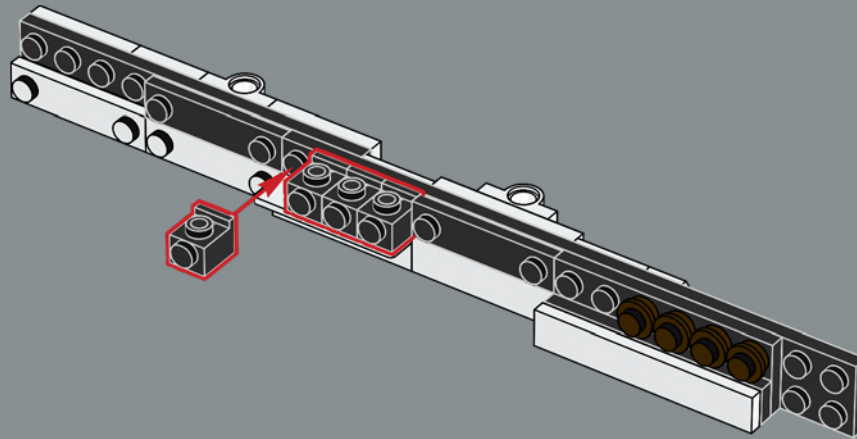

285

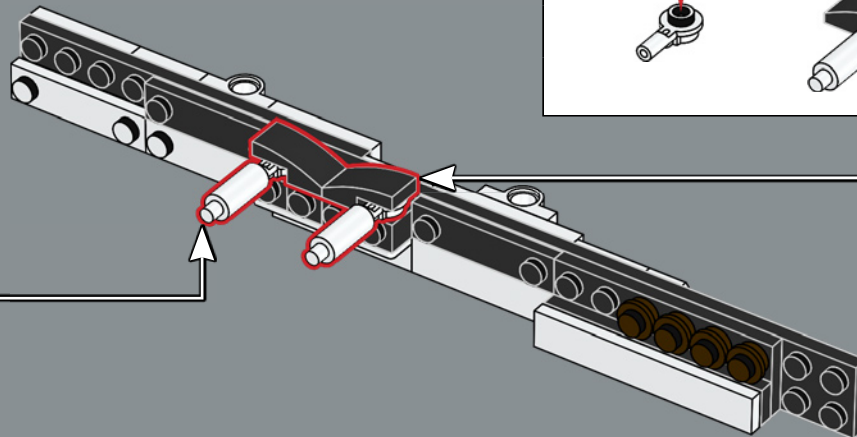
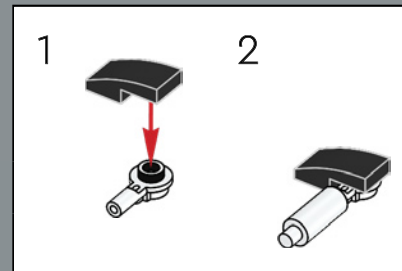
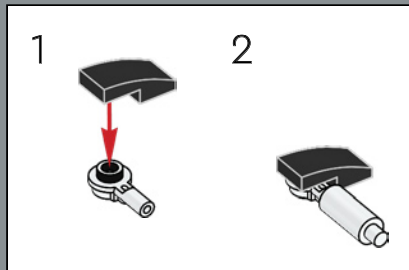

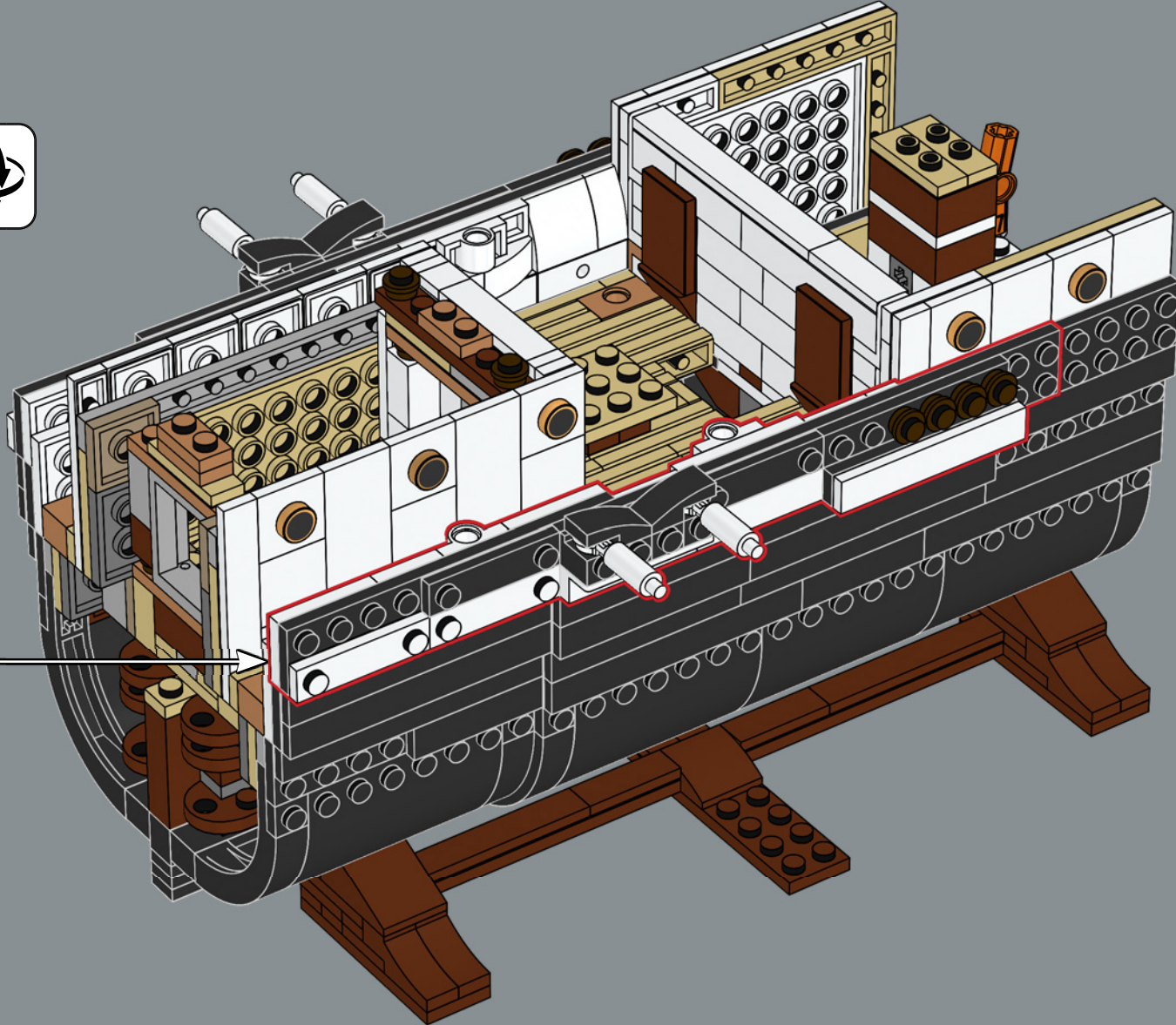

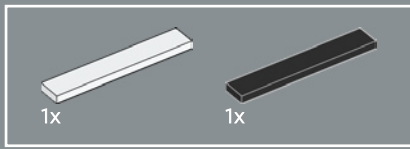

287

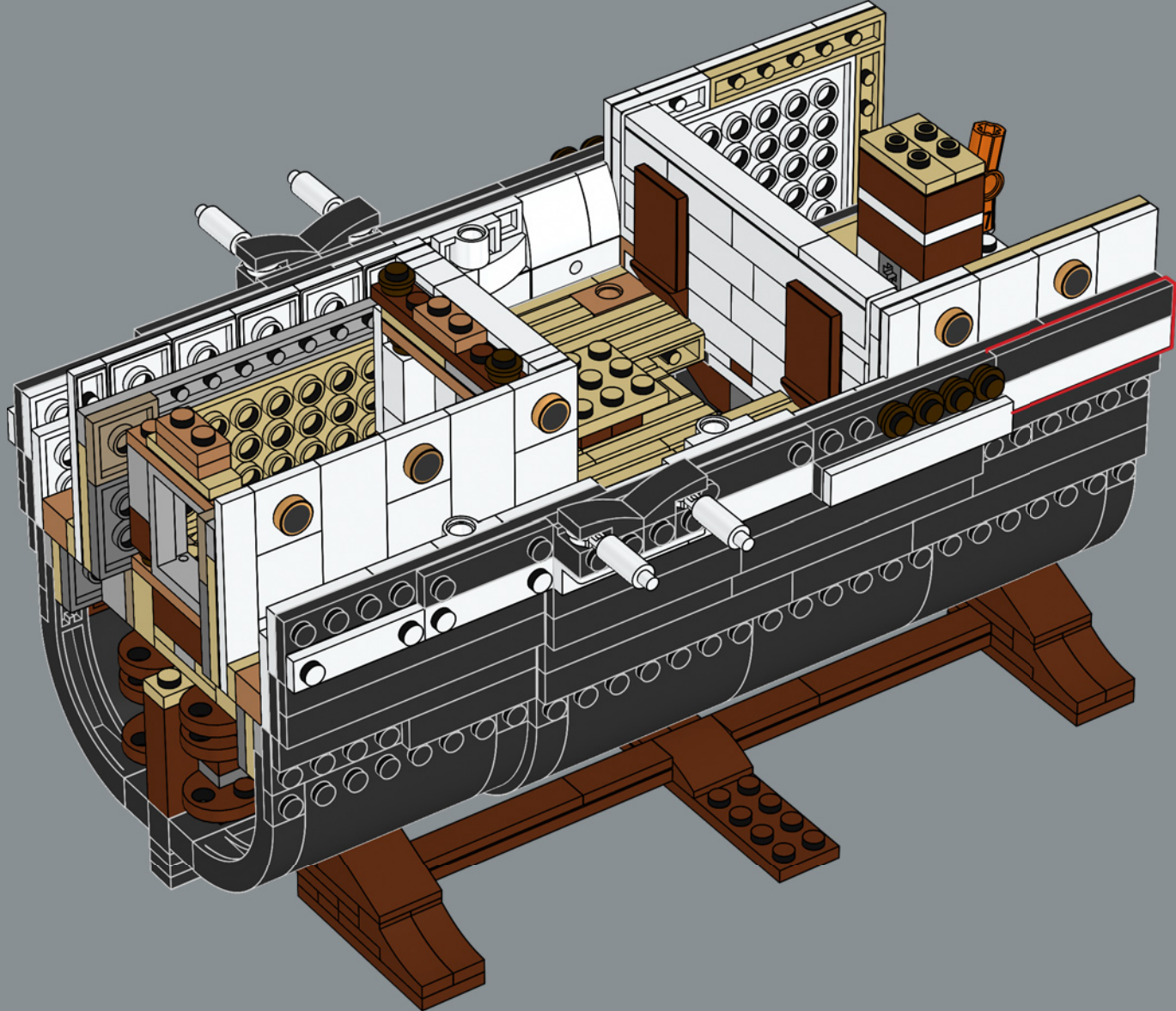

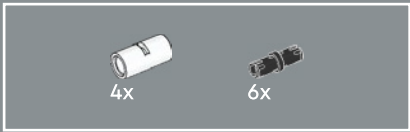

288

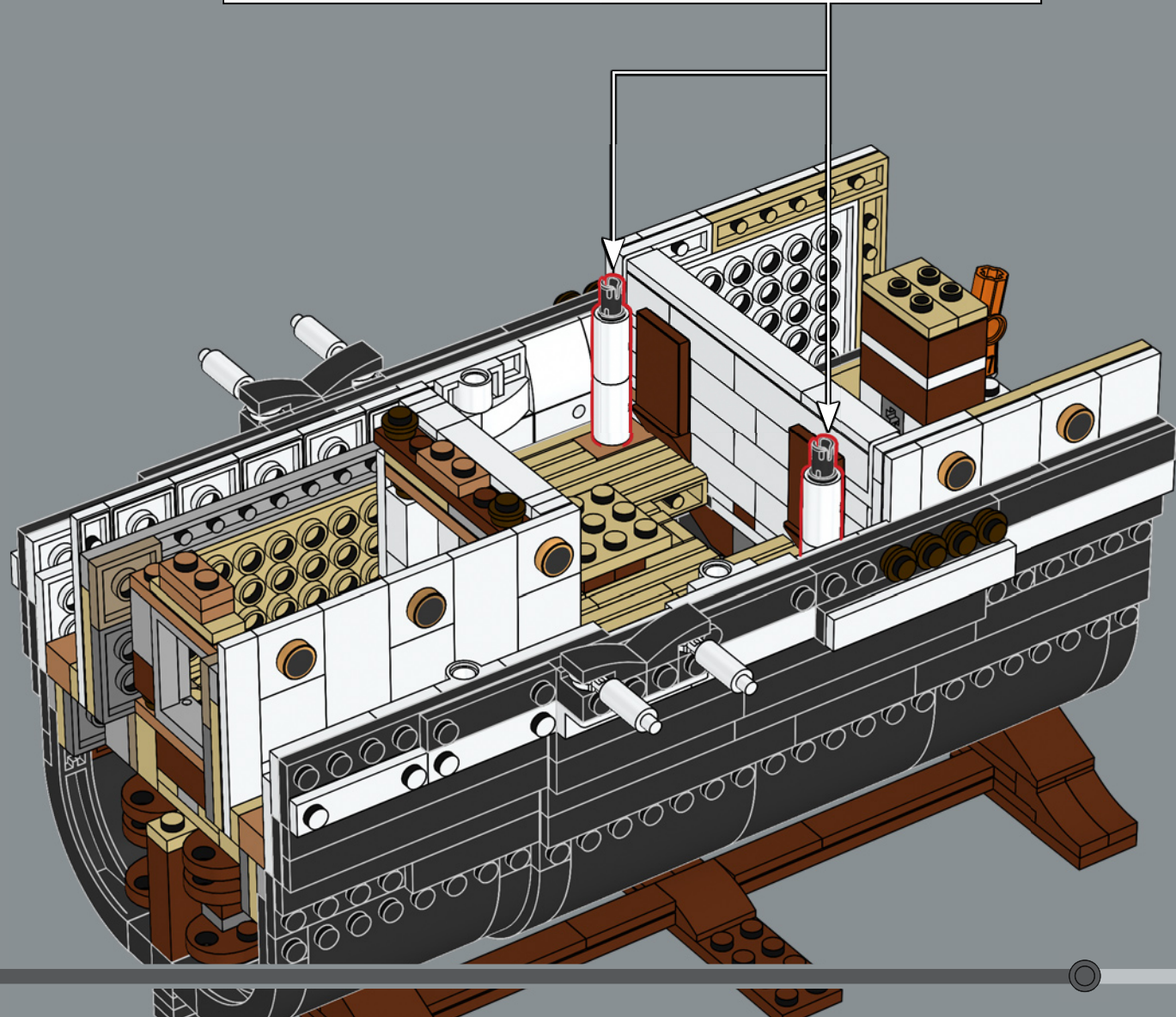
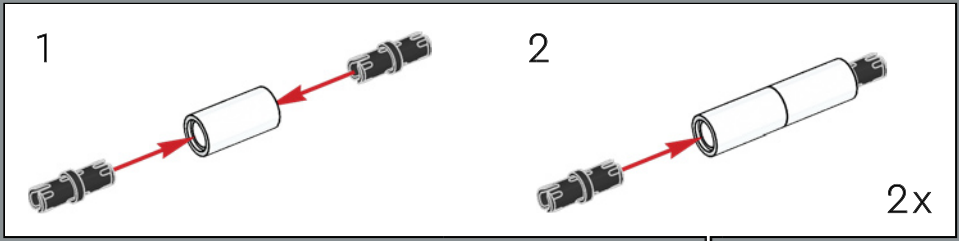

289

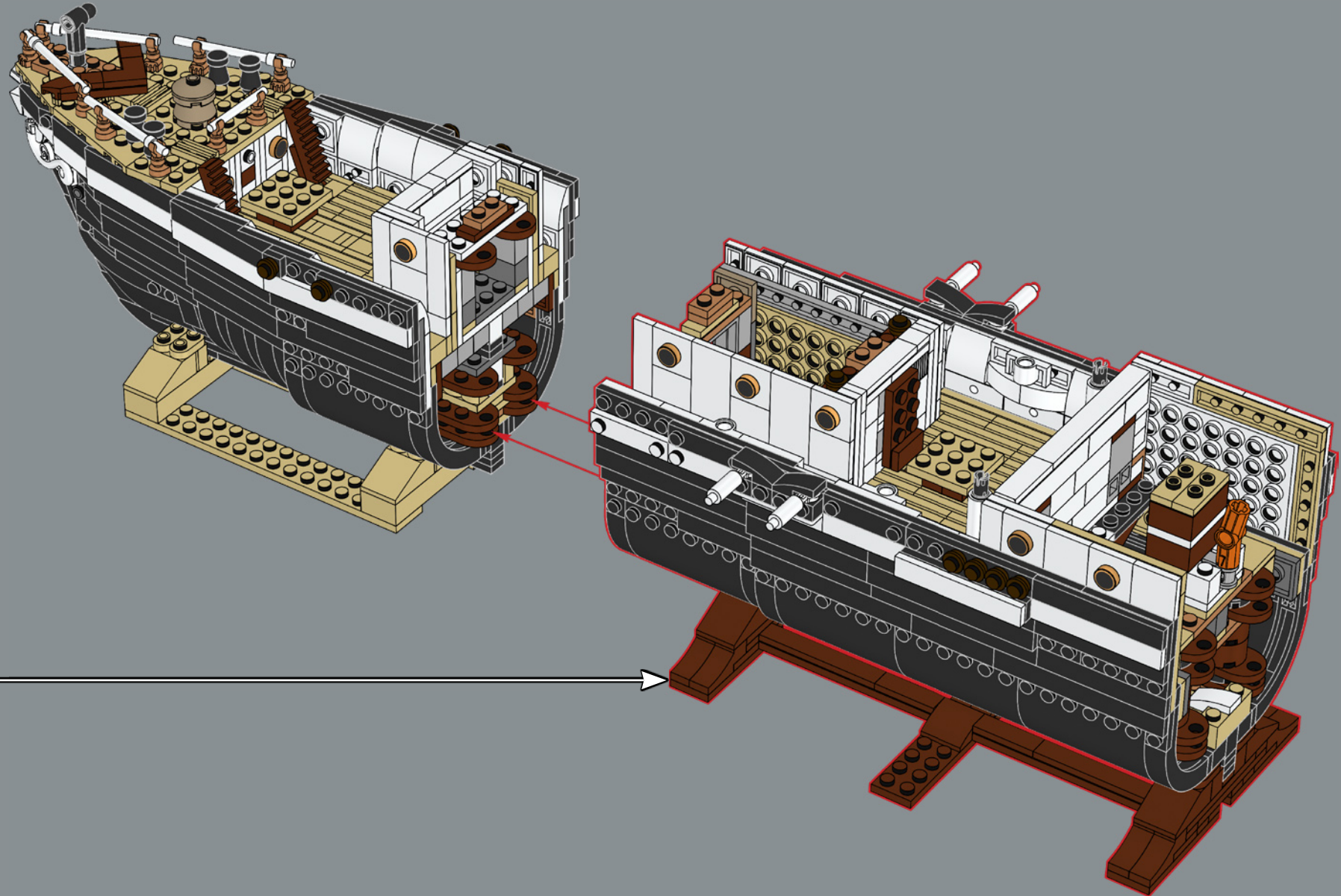

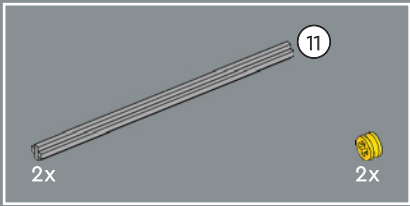

290

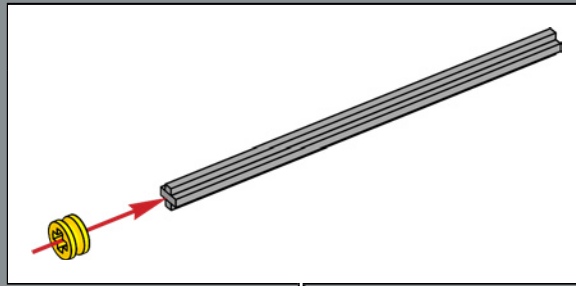

Los maestros artesanos lograron hacer del Endurance uno de los barcos de madera más resistentes jamás construidos reforzando el casco de todas las maneras posibles. En el modelo LEGO®, las tres secciones del casco están unidas por ejes LEGO Technic que las mantienen en su lugar con gran firmeza.

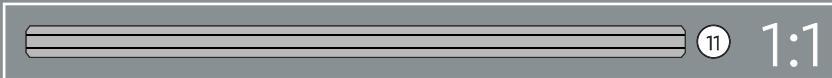
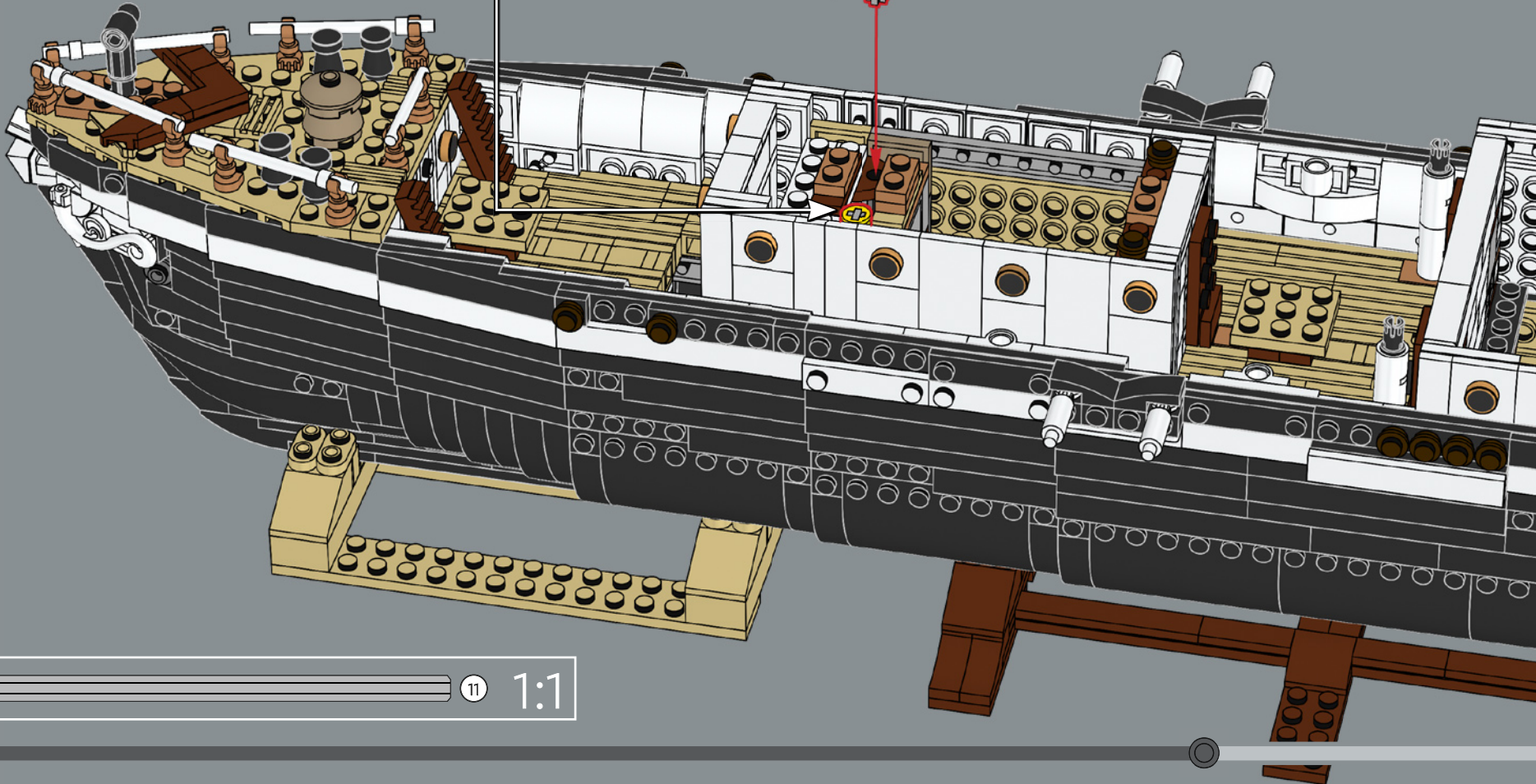

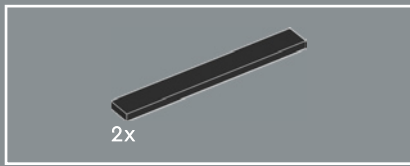

291

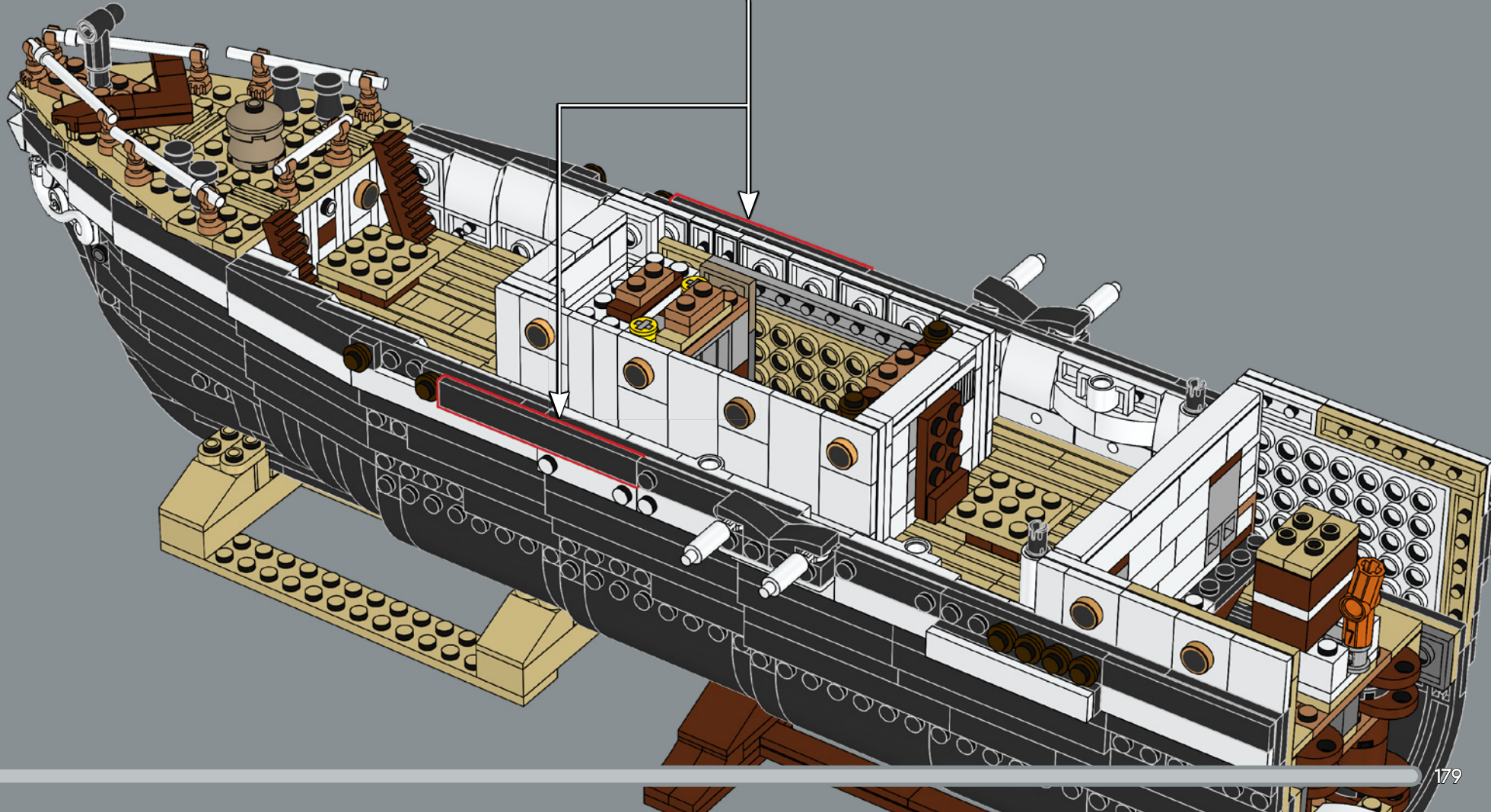
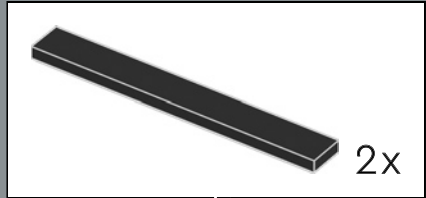

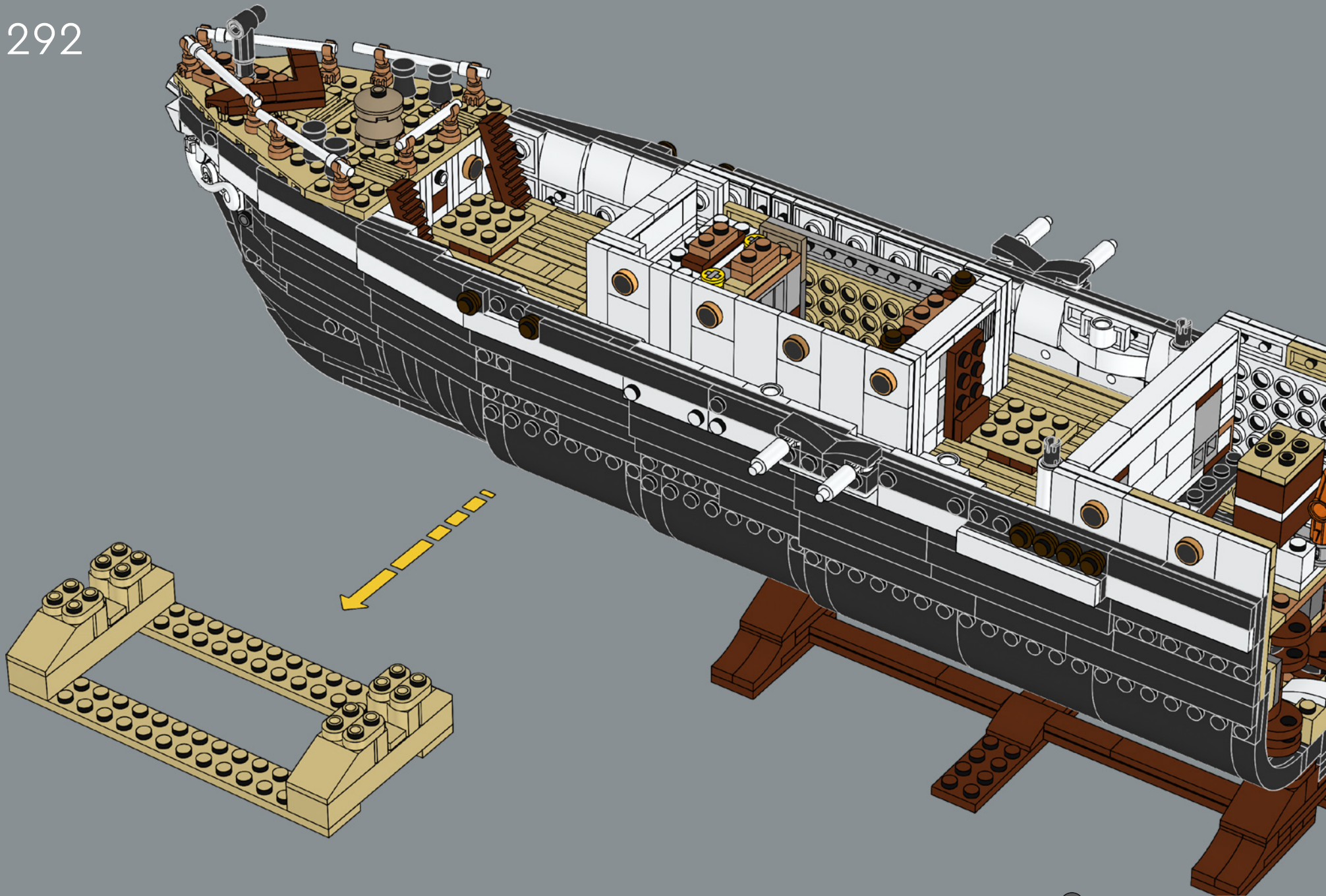

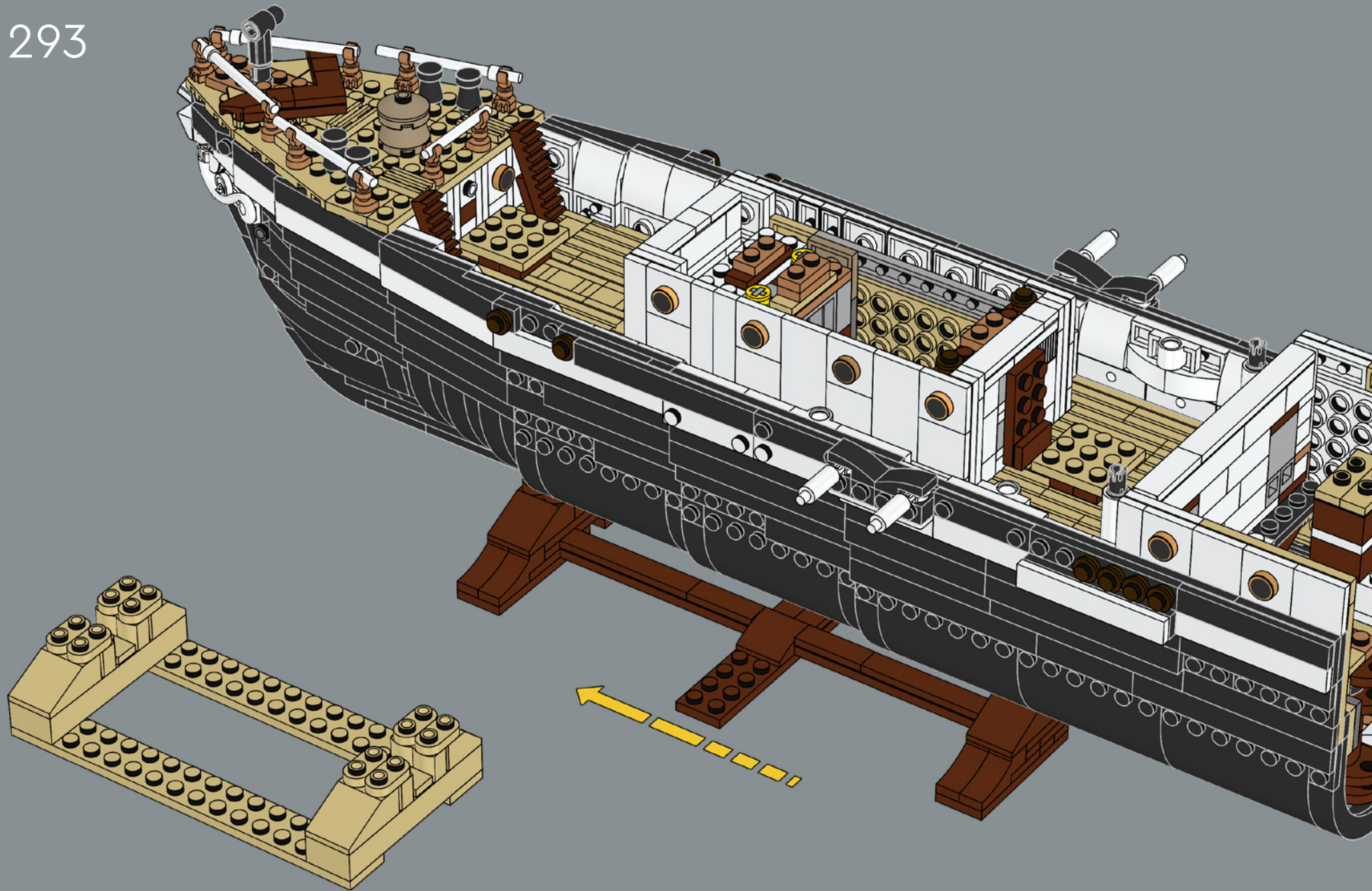

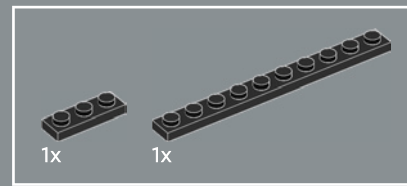
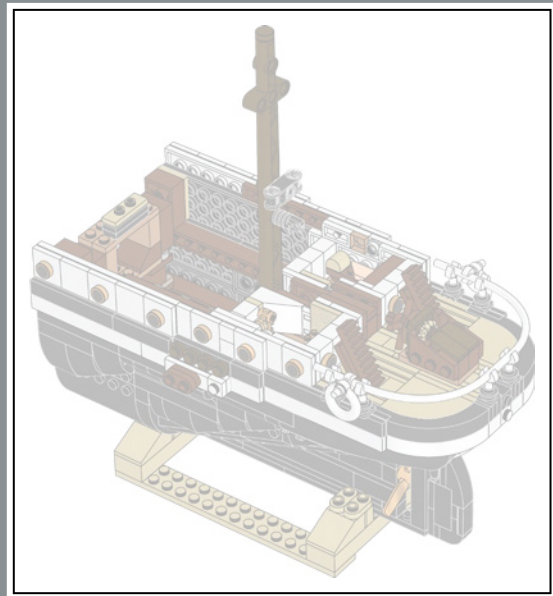
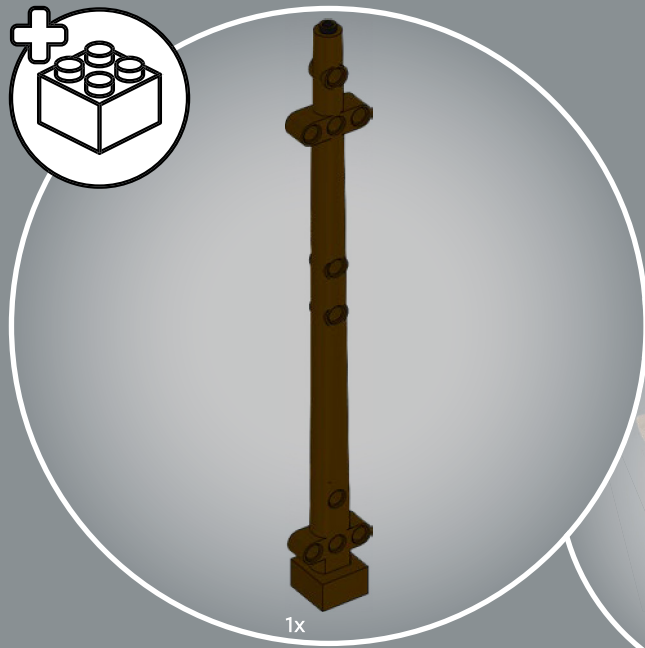
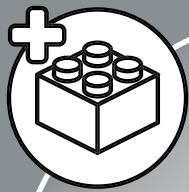

294

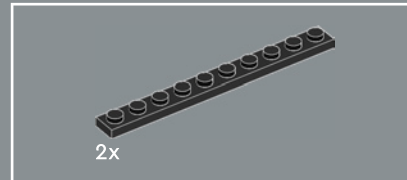
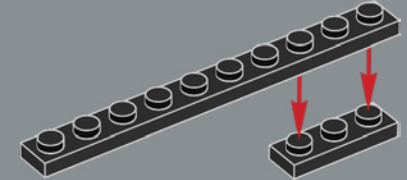

295

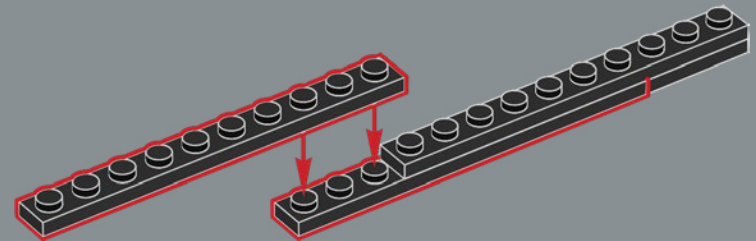

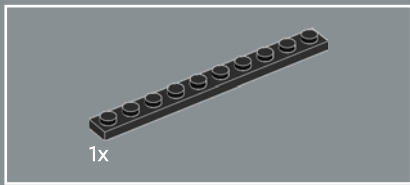

1x

296

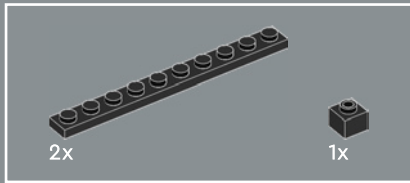
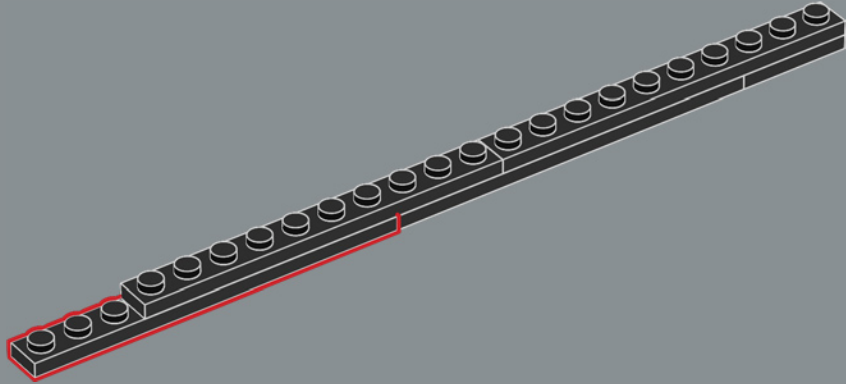

2x

1x

297

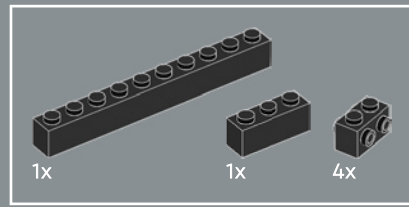
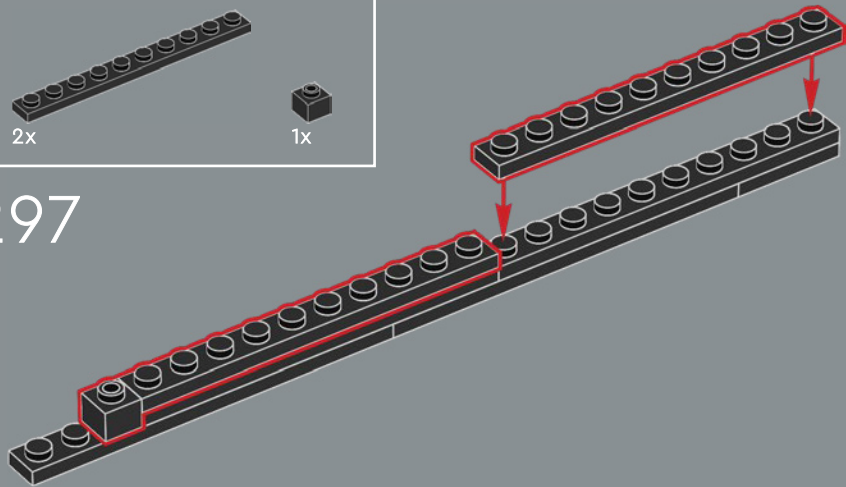

1x

1x

4x

298

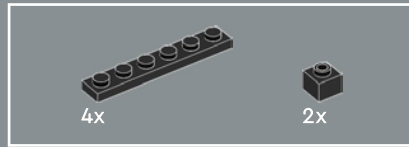
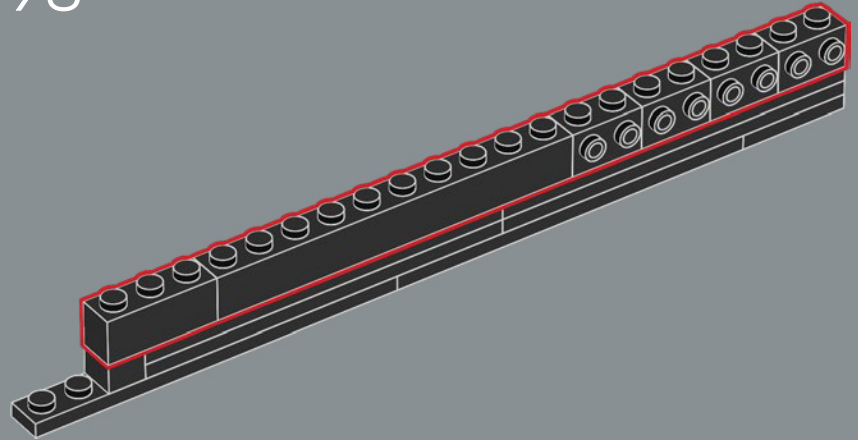

4x

2x

299

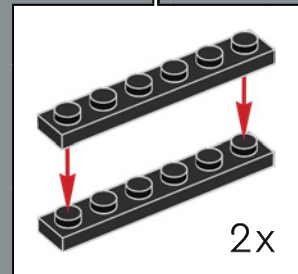
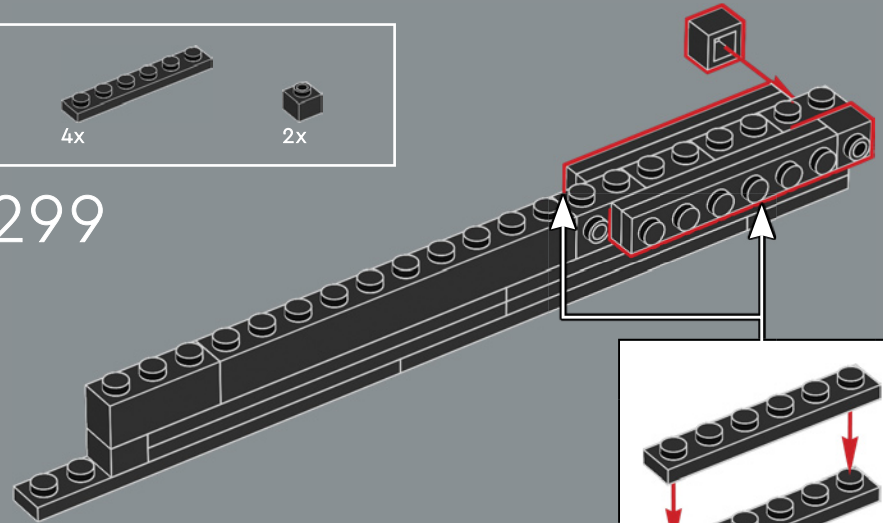

2x

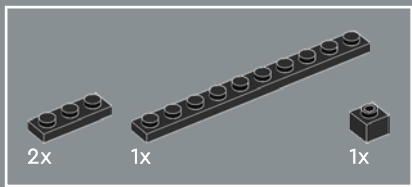

300

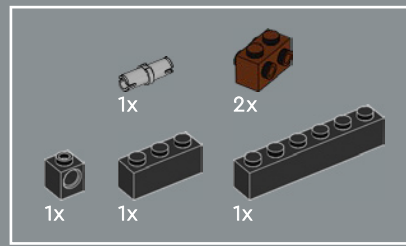
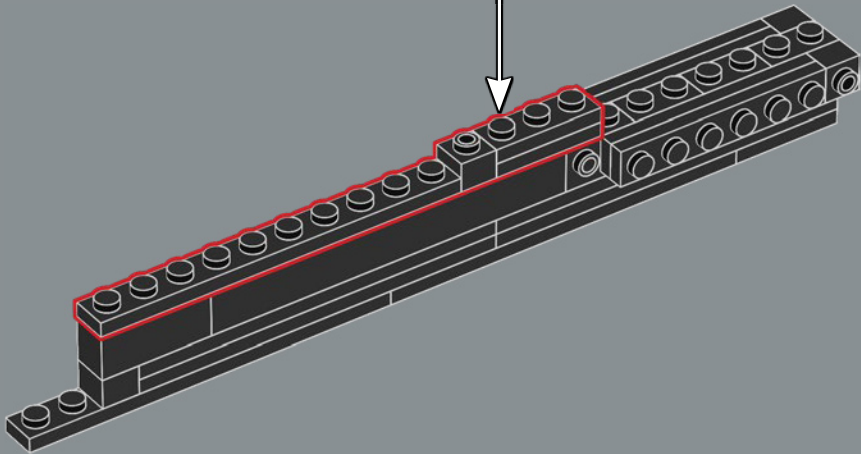
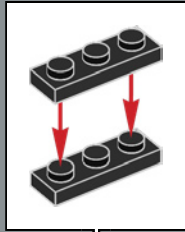

301

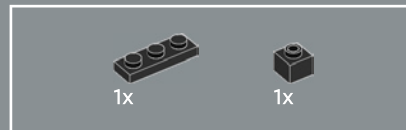
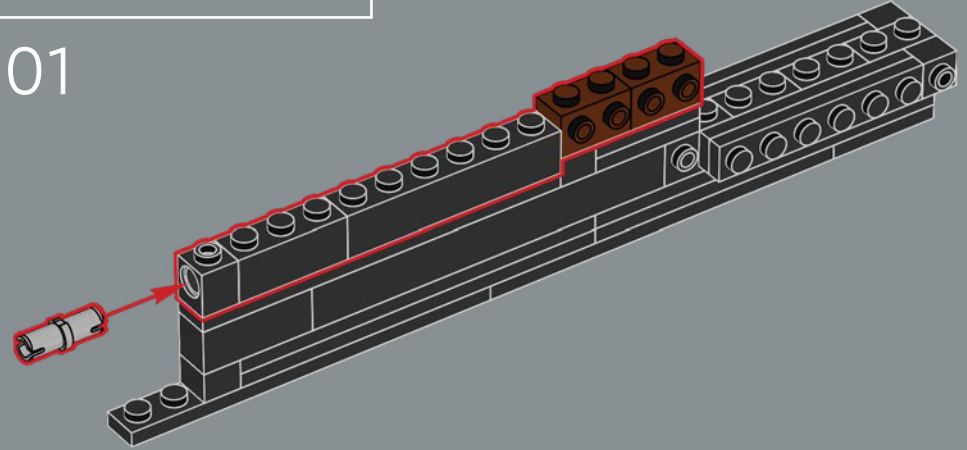

302

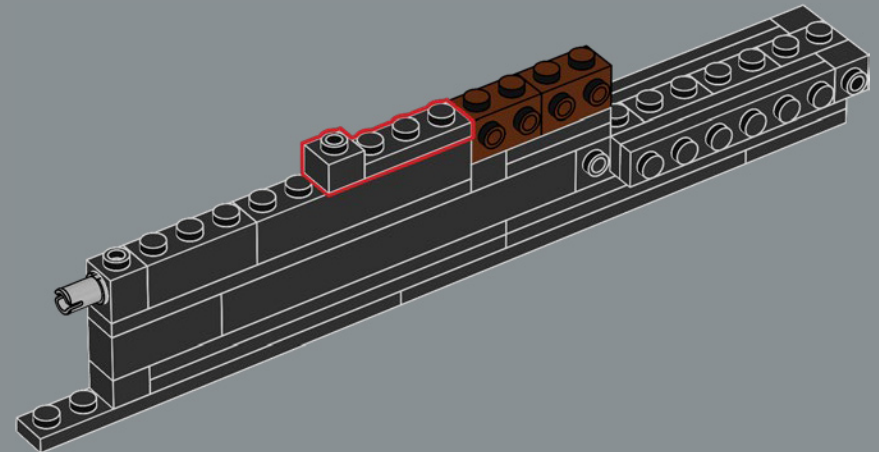

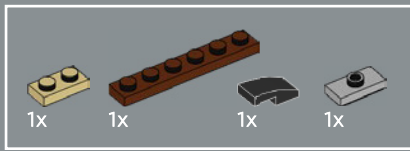

303

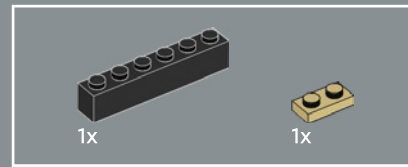
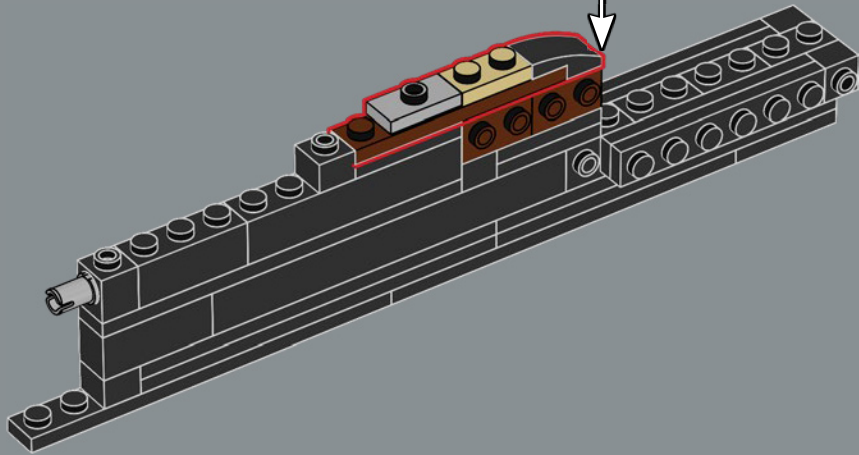
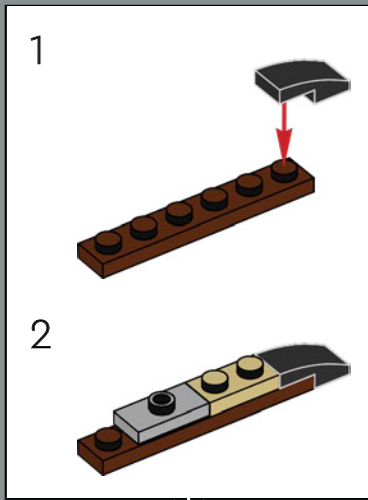

304

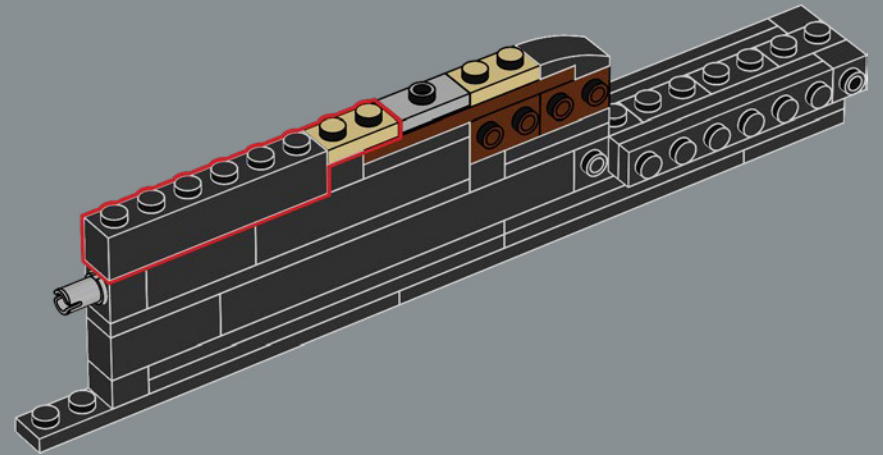



305

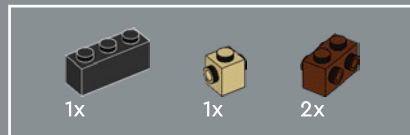
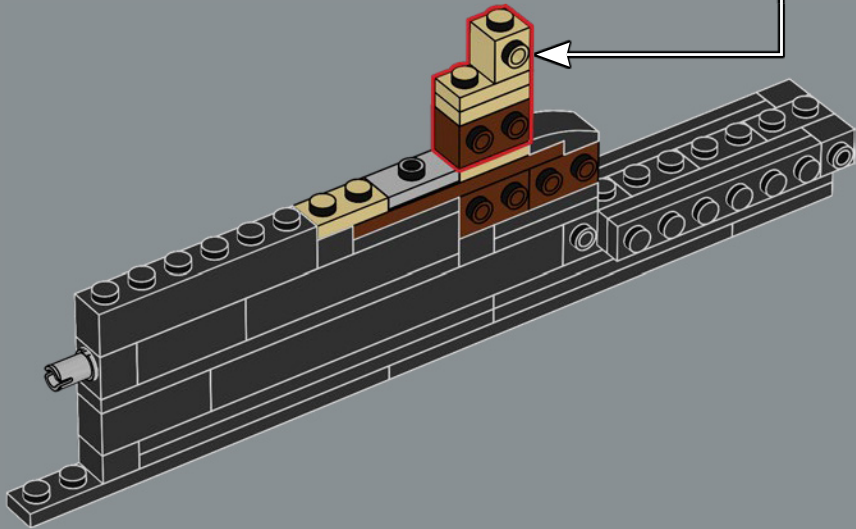
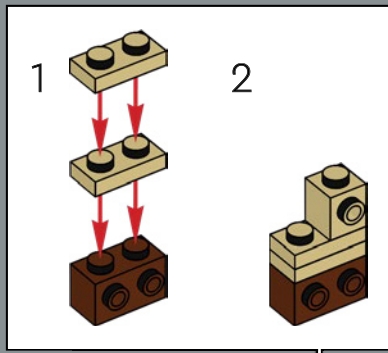

306

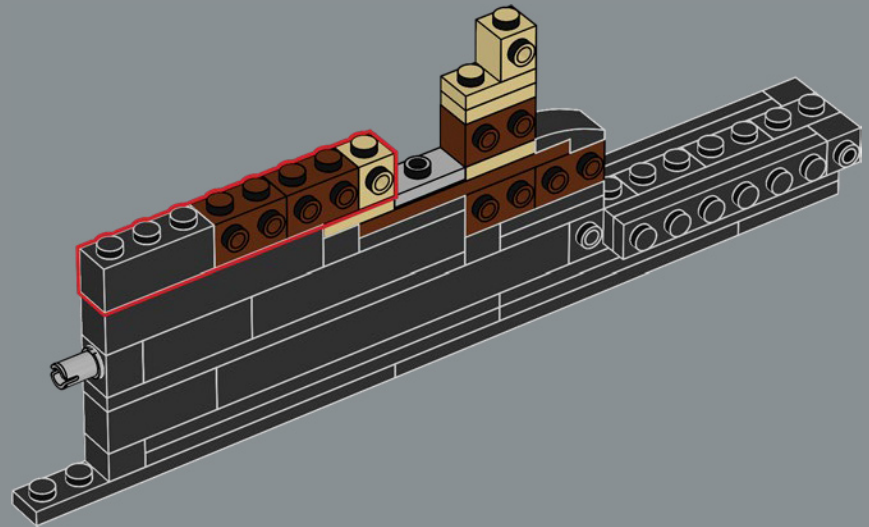

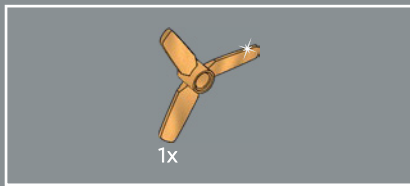

La hélice del Endurance de la vida real era negra, pero el elemento LEGO® que la recrea se fabricó en dorado para hacerla más visible y distinguirla del casco.



307

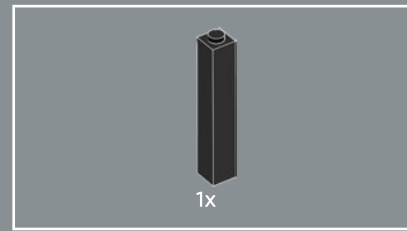
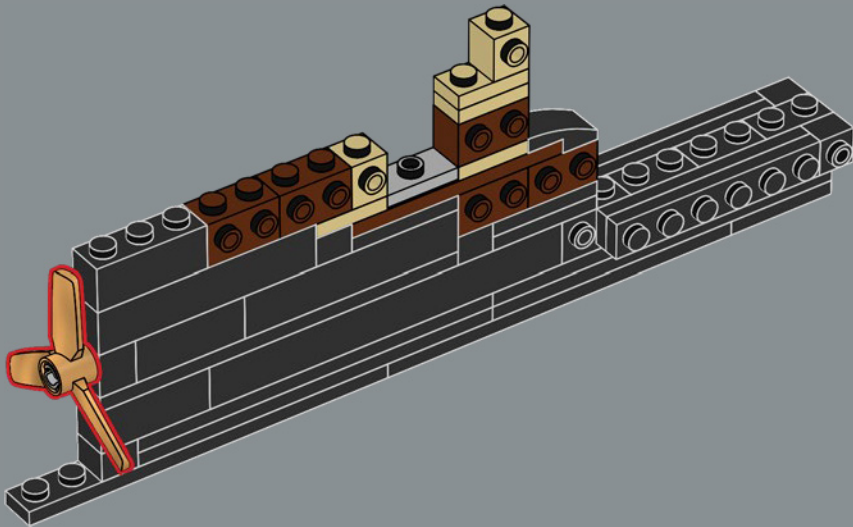

308

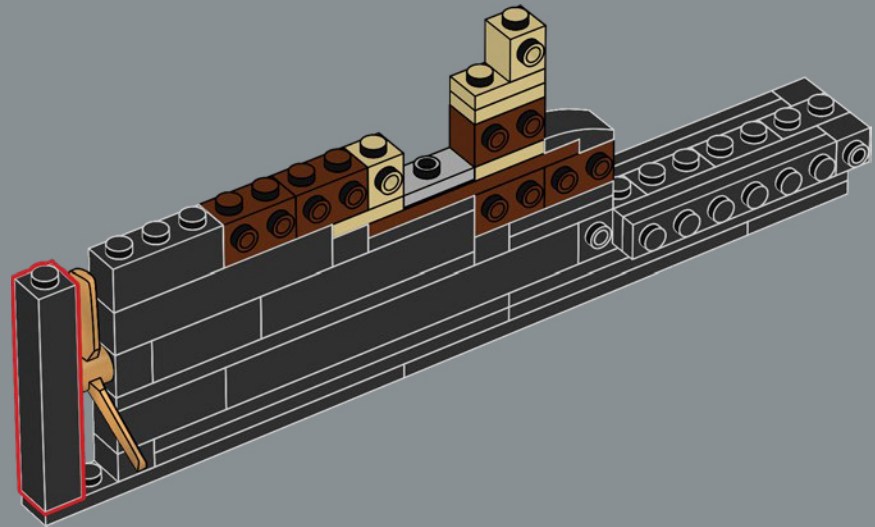

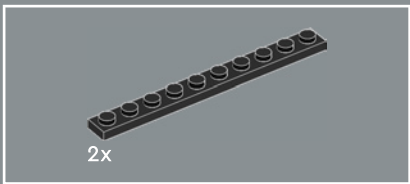

309

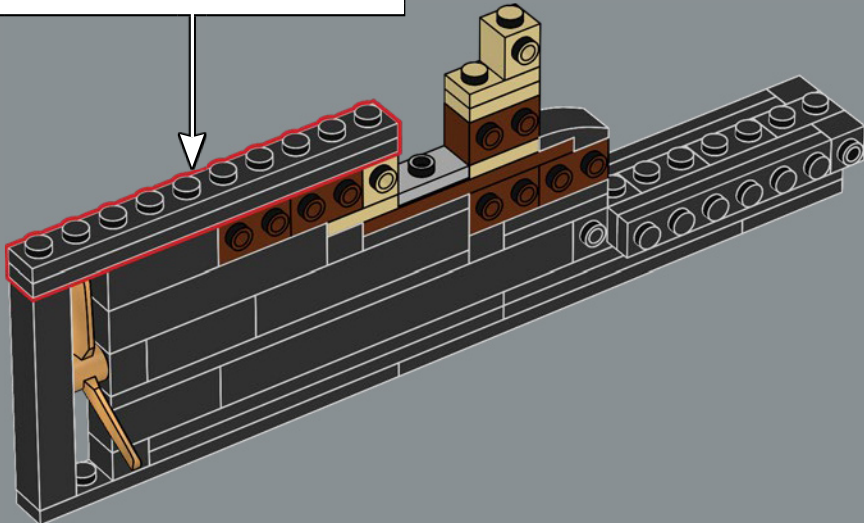
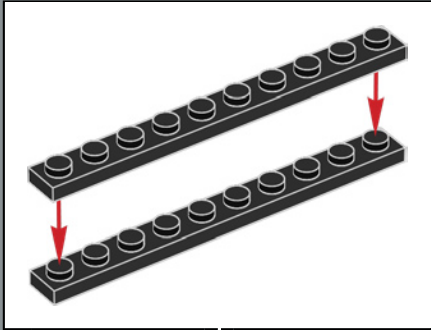

310

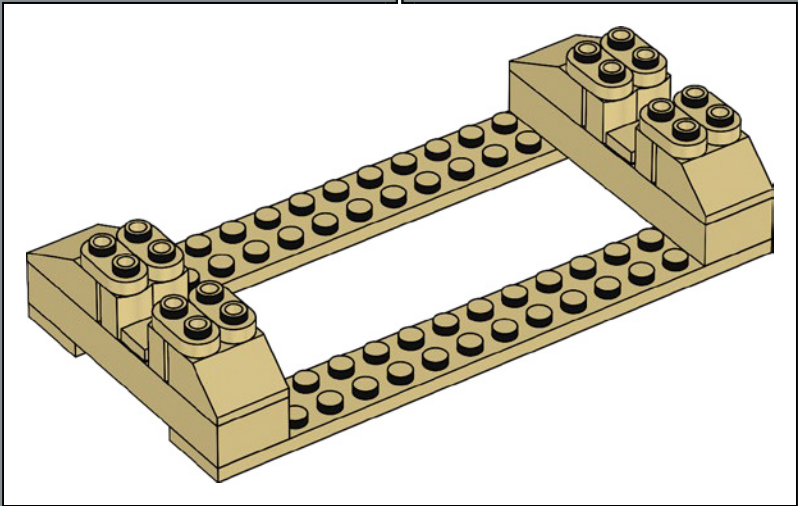
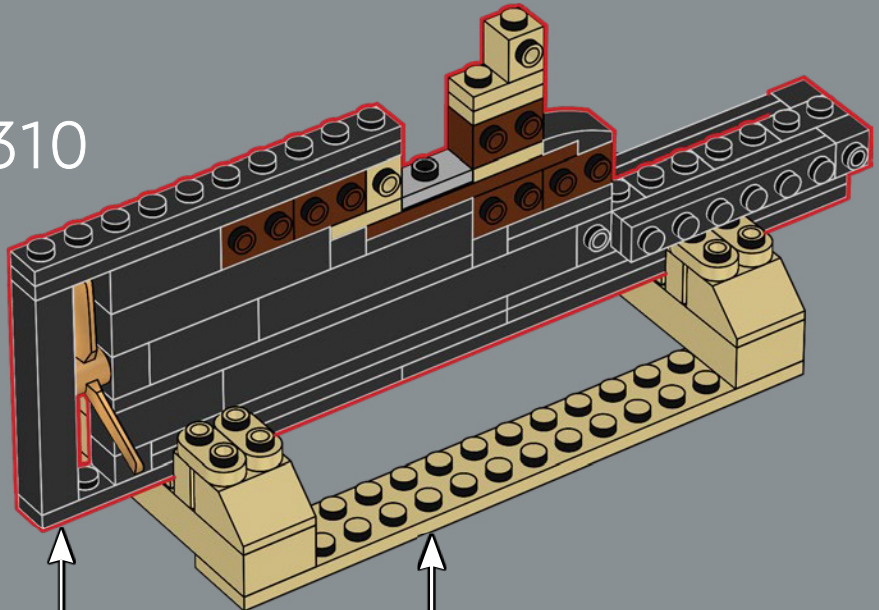

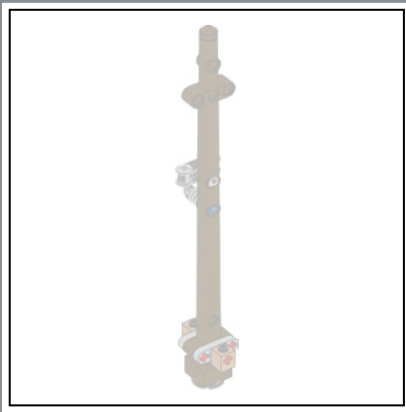

1



2

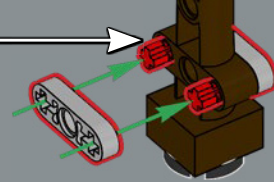
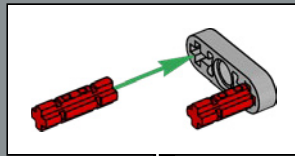

3

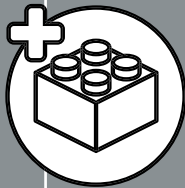
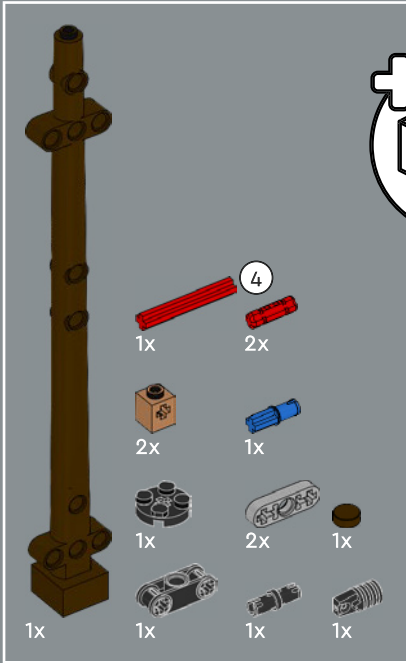
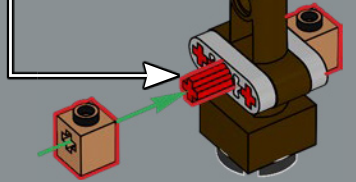
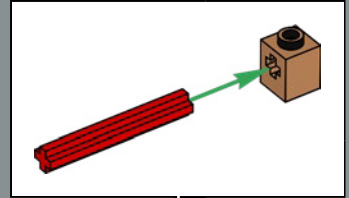

311

4

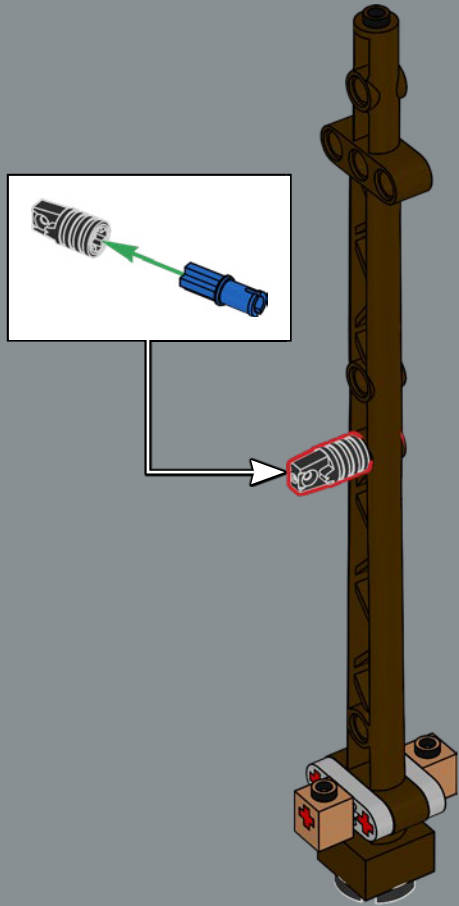

5

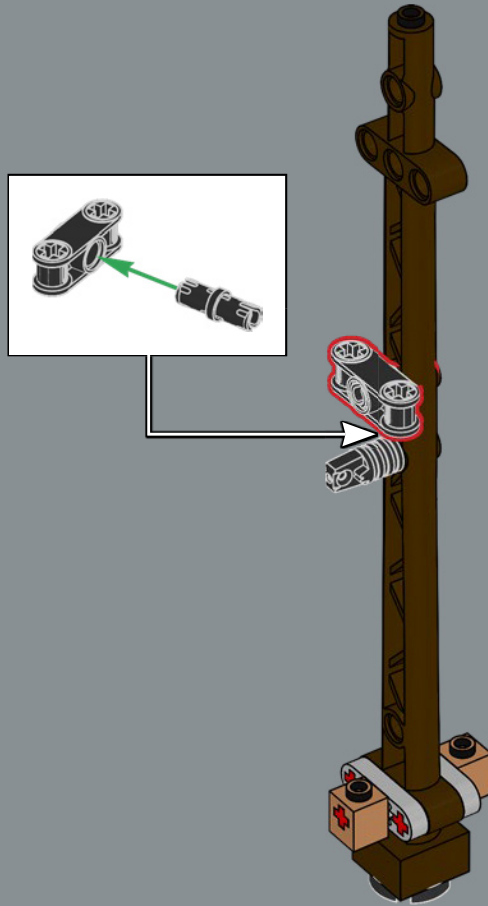

6

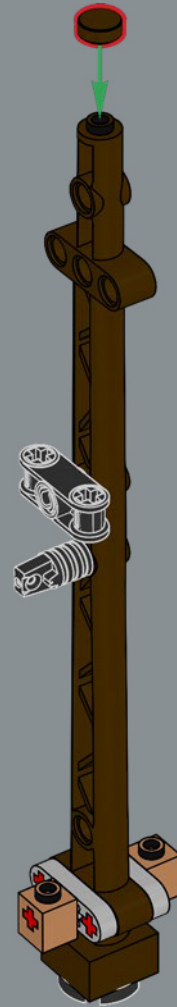

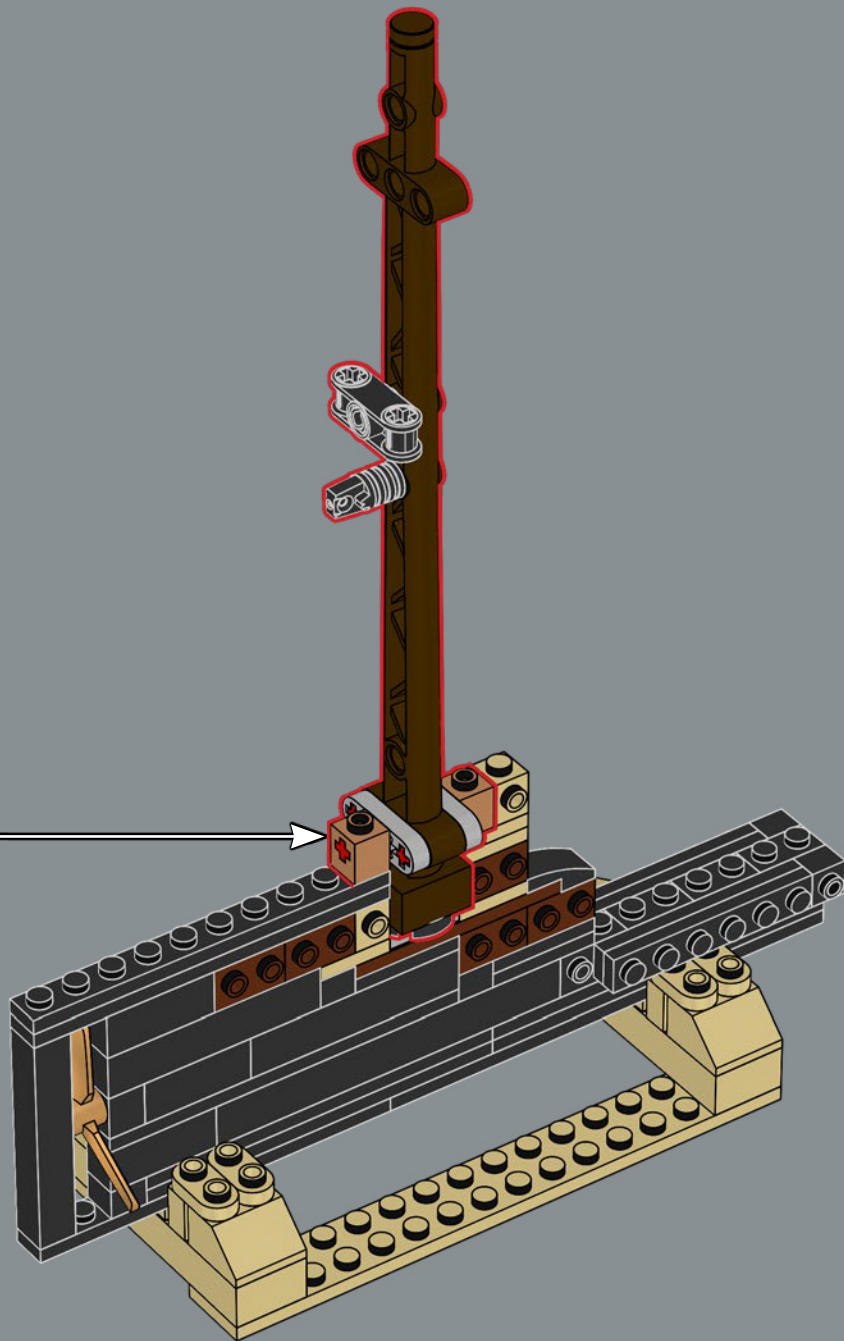

312

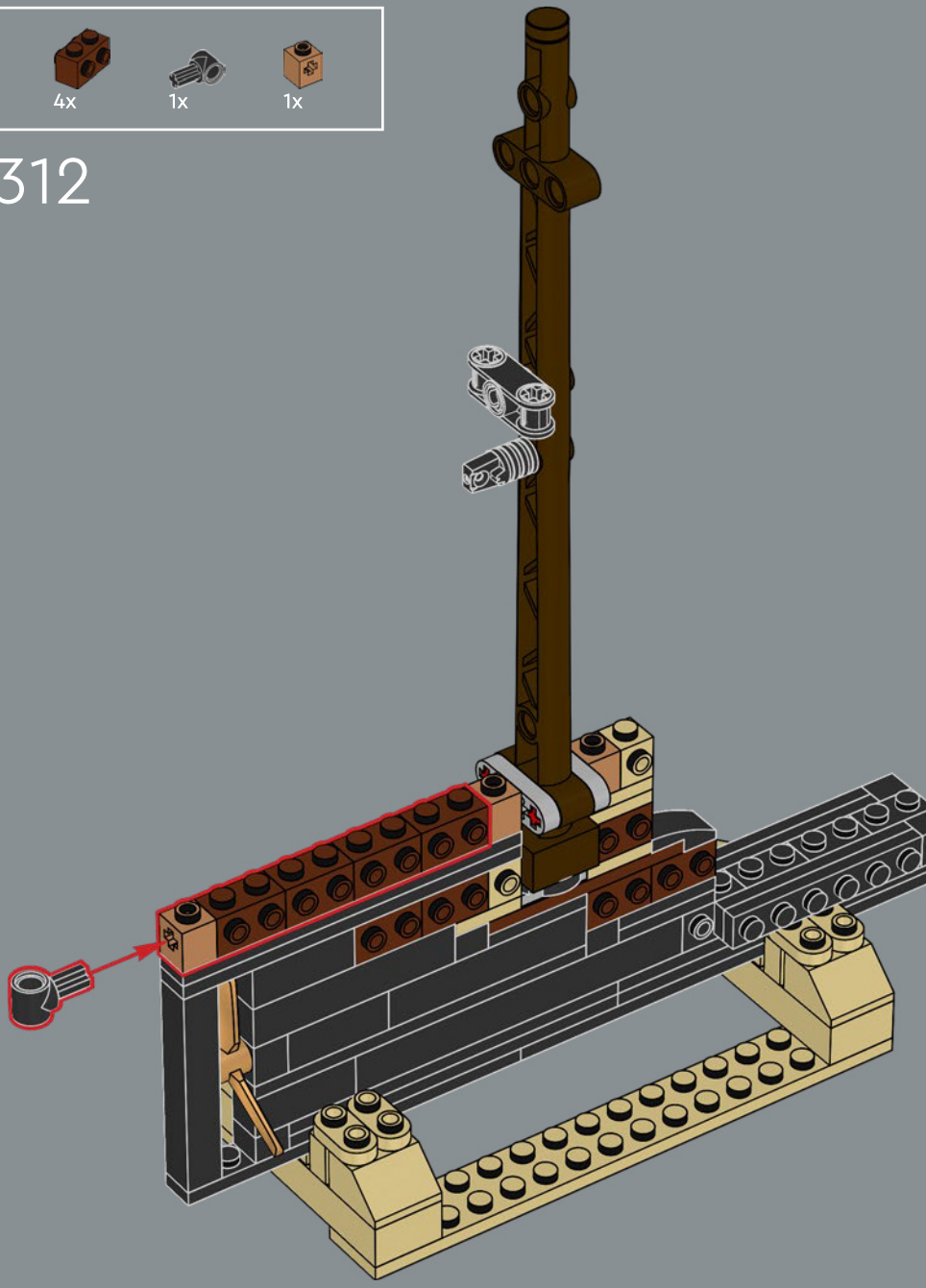

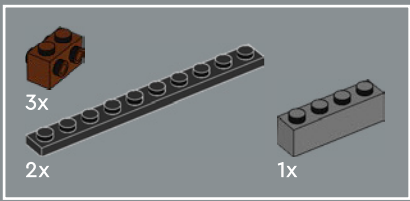

313

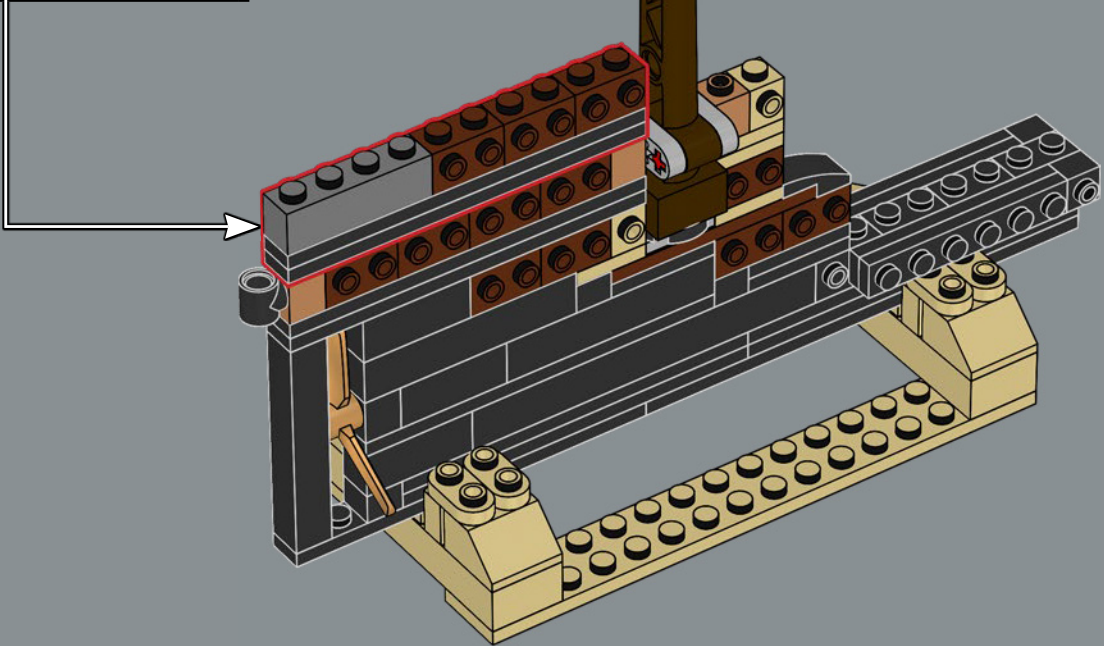
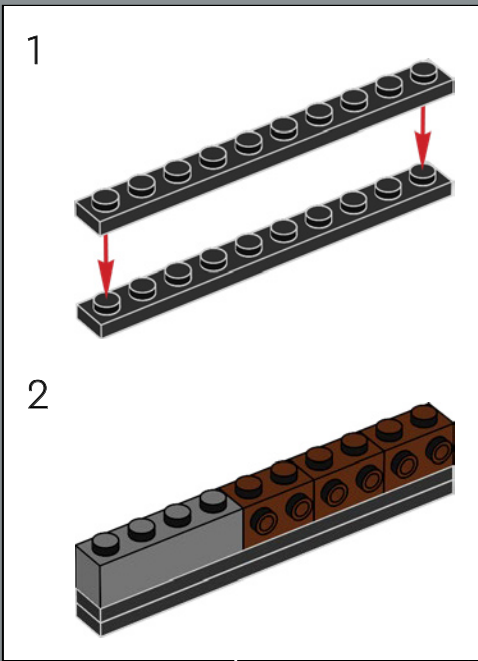

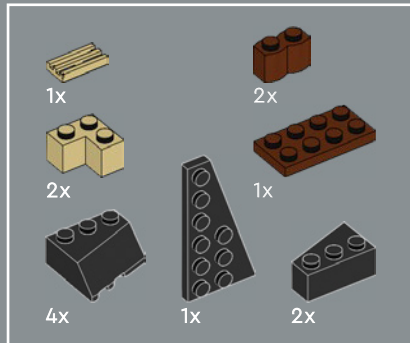
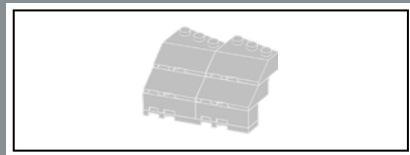

314

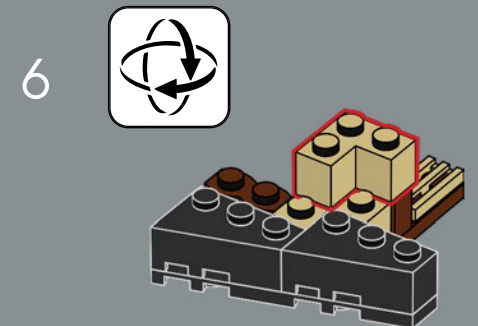
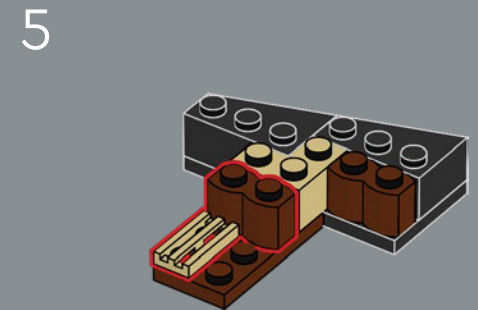
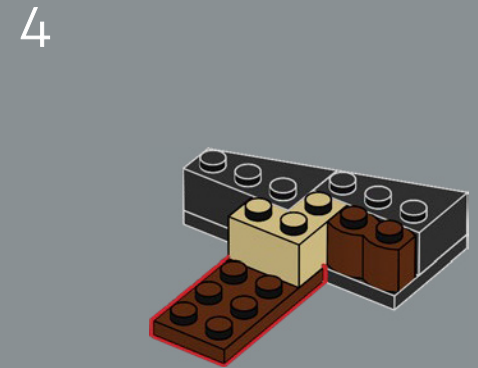
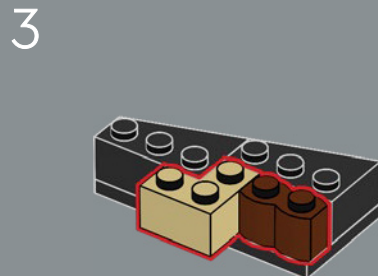
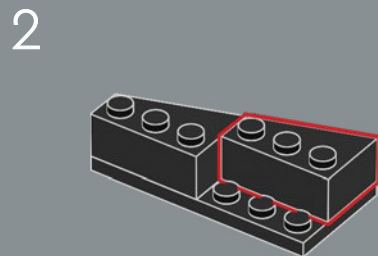
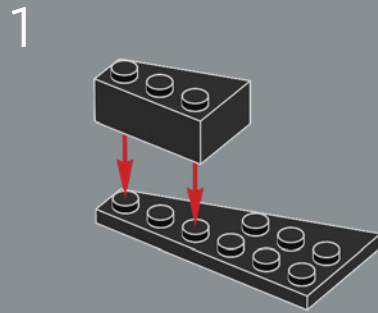

7

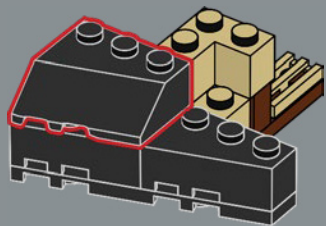

8

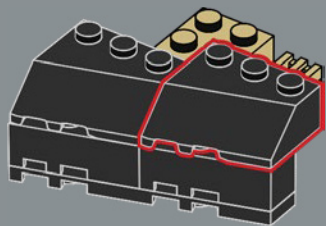

9

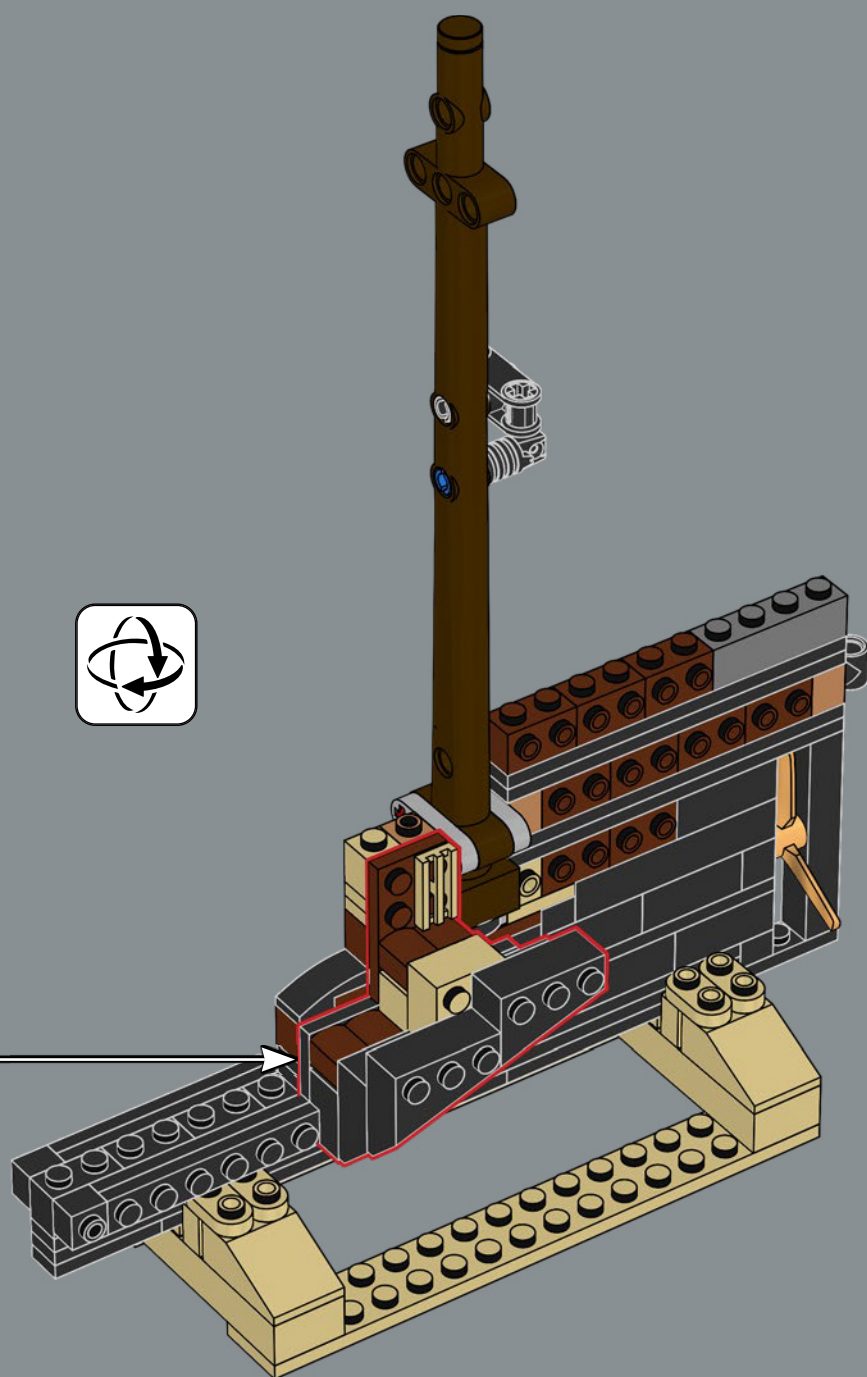
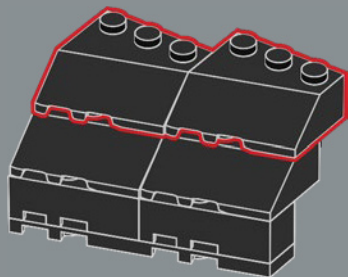

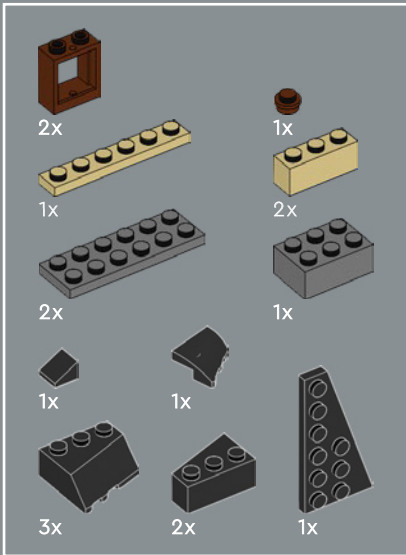
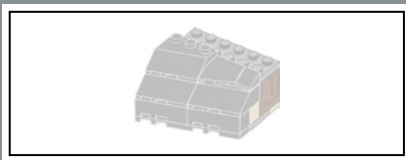

315

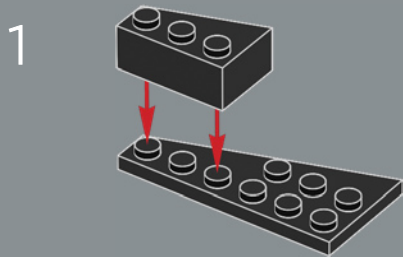

2

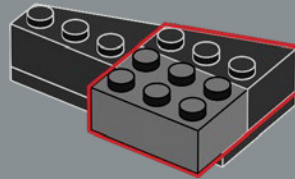

3

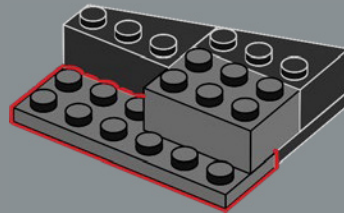

4

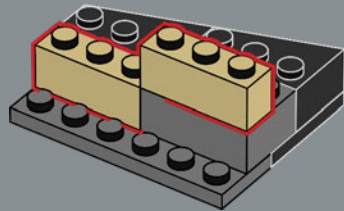

5

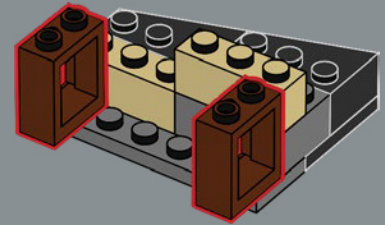

6

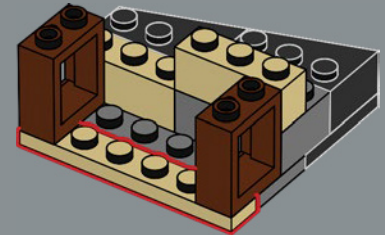

7

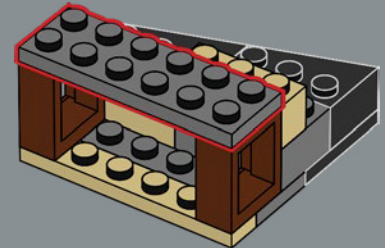

8

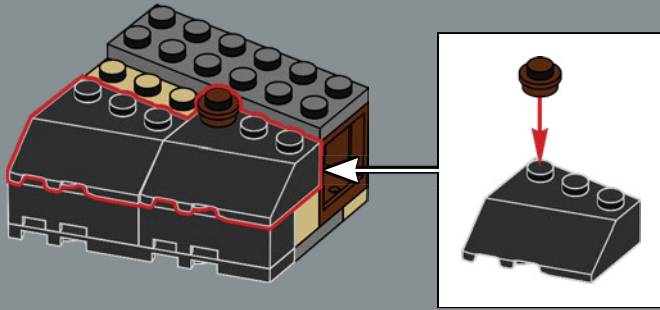

9

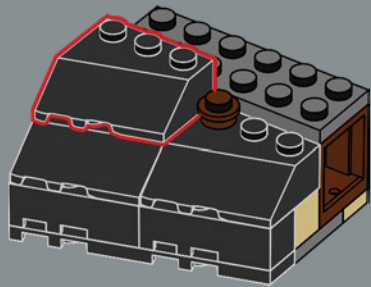

10

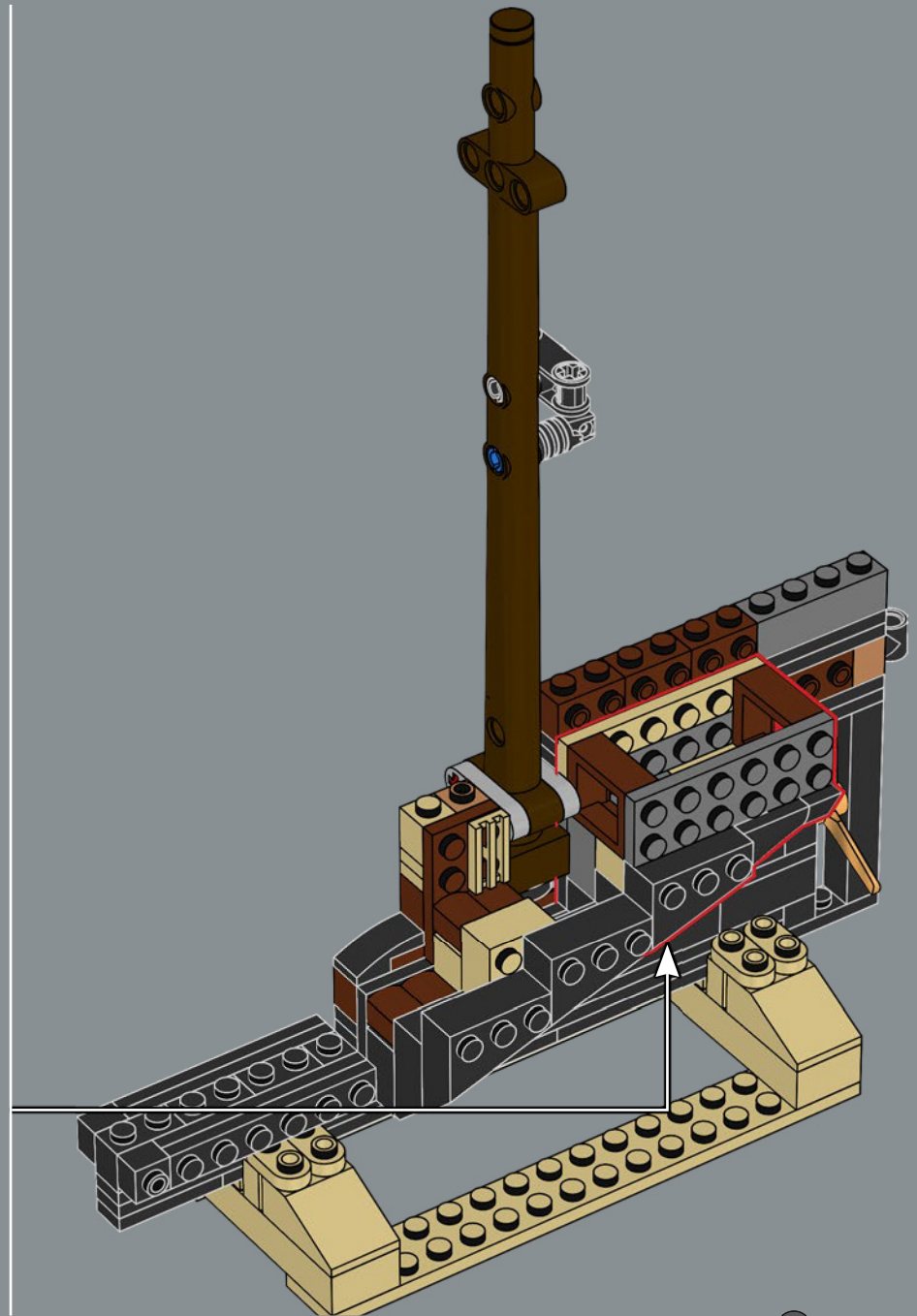
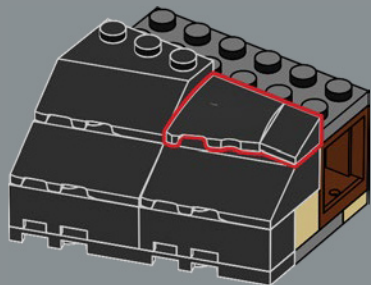

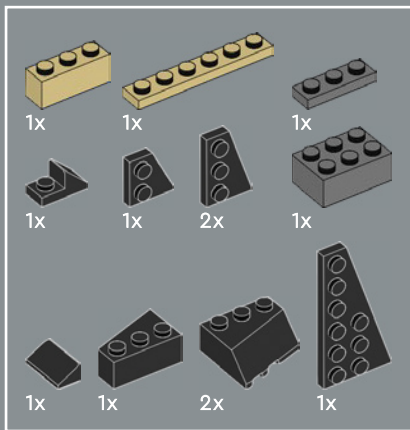

316

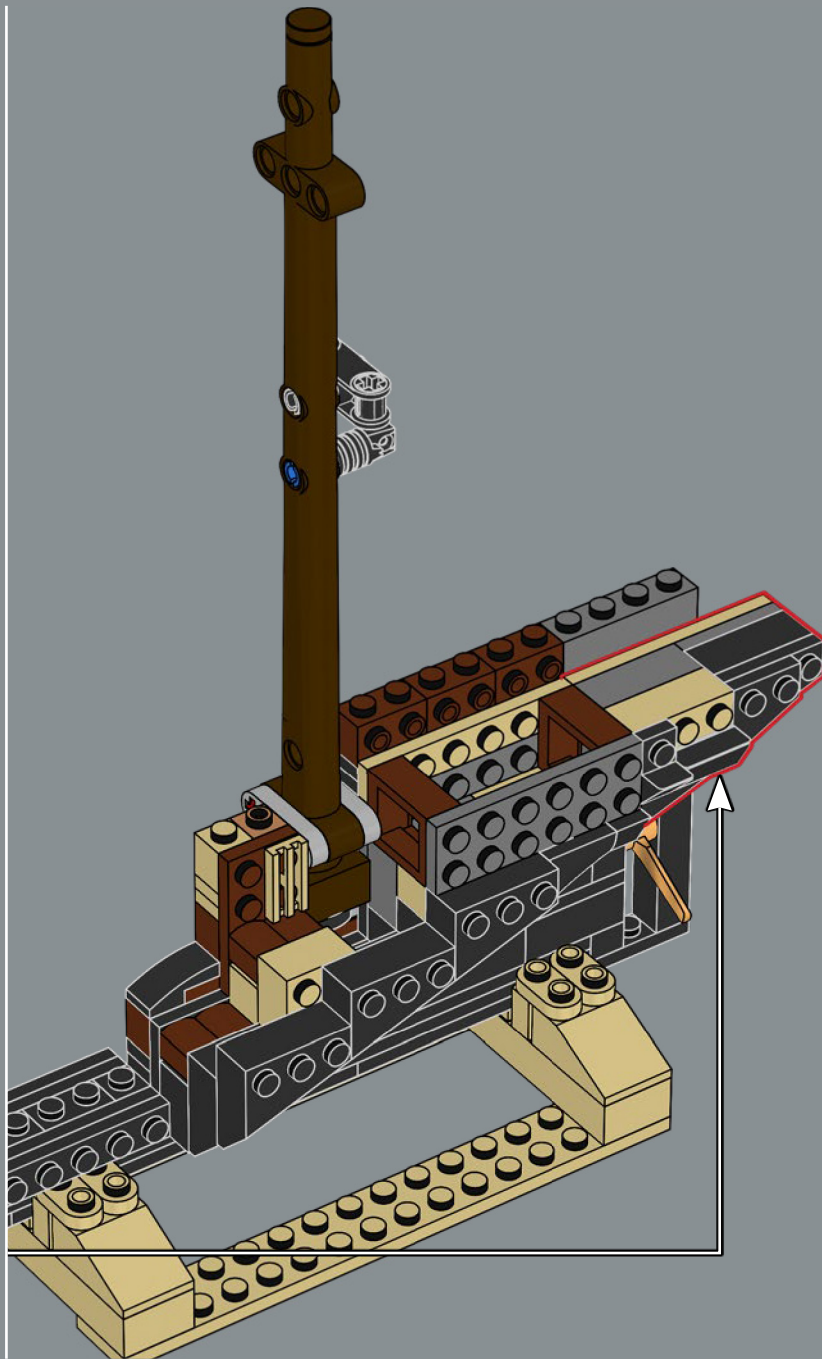
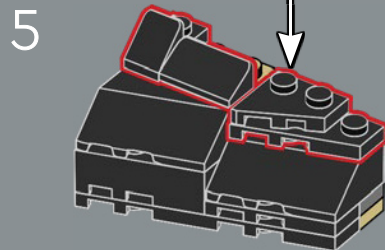
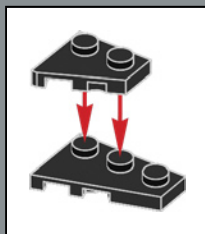
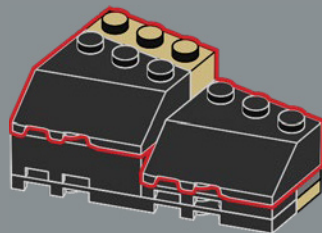
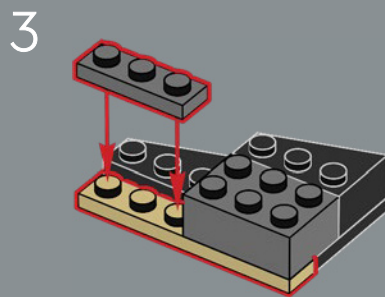
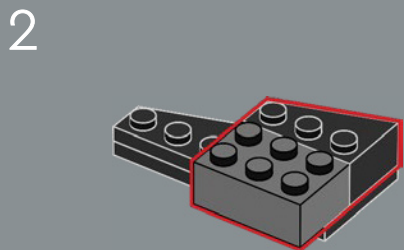
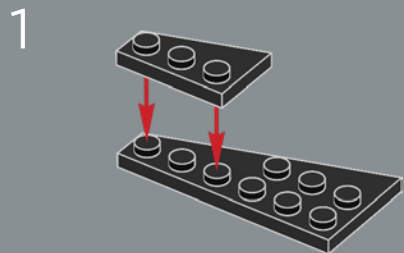

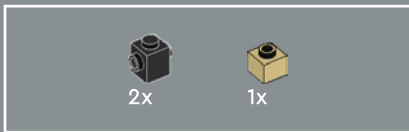

317

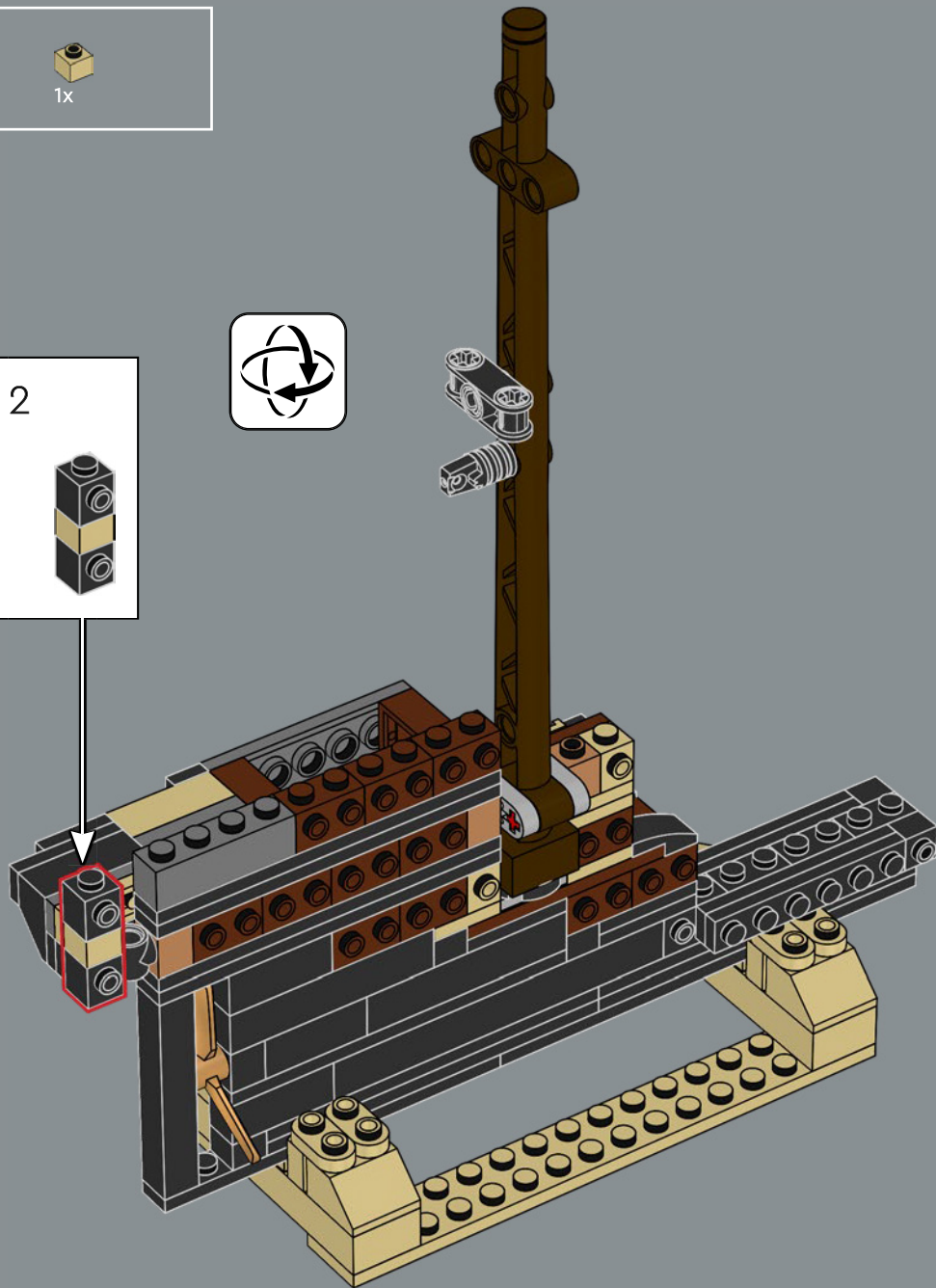
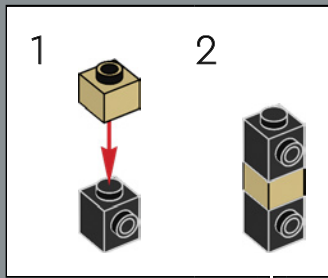

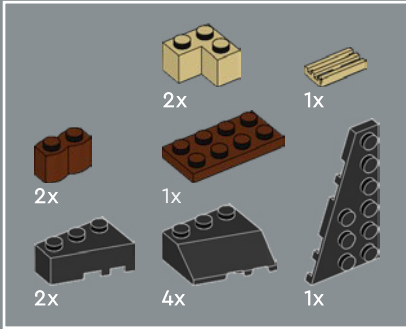
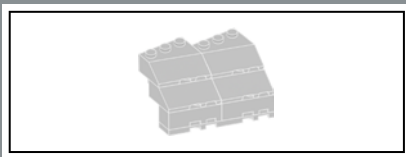

318

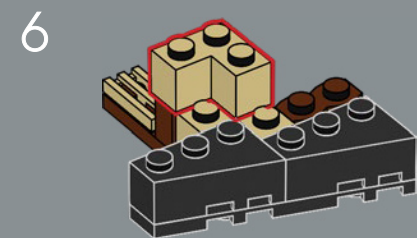
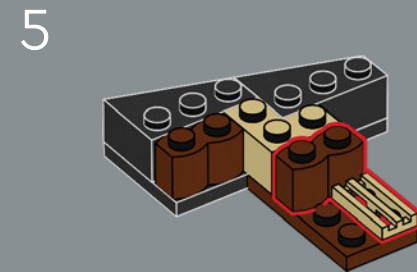
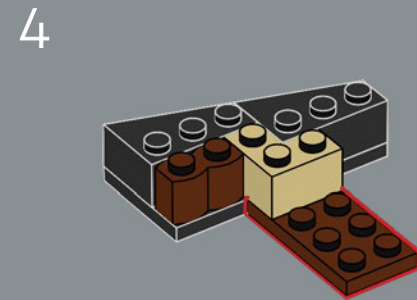
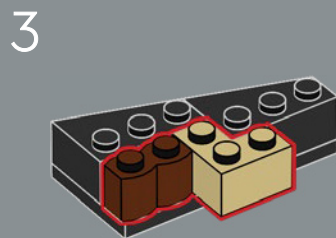
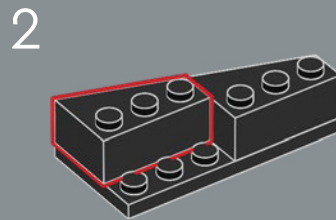
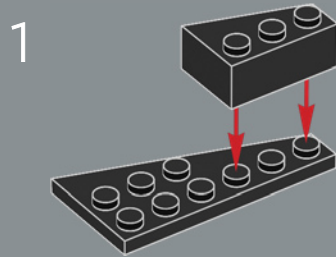

7

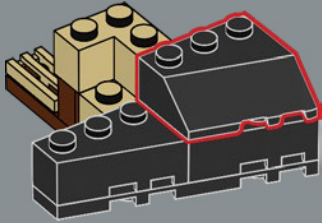

8

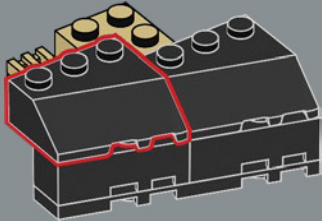

9

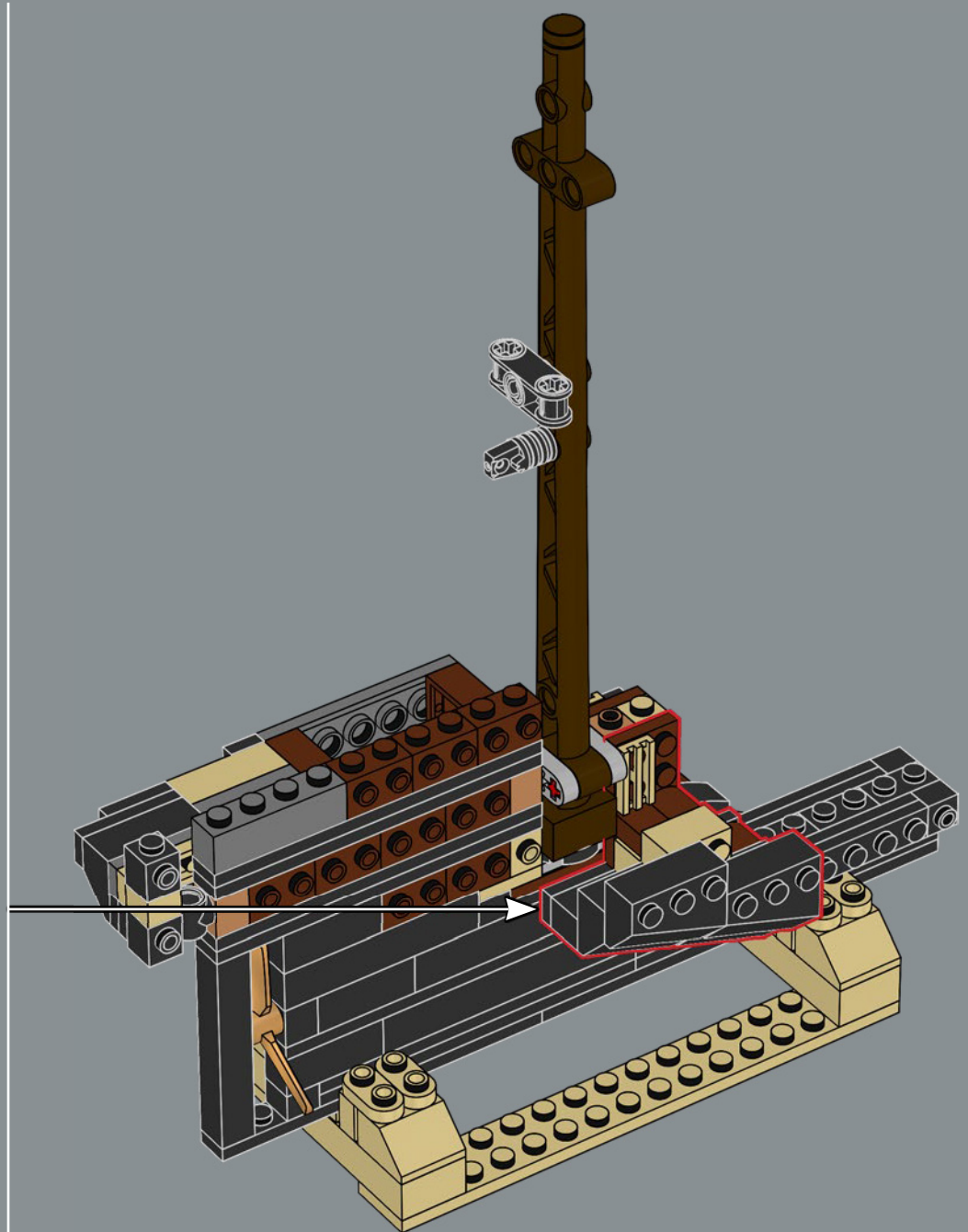
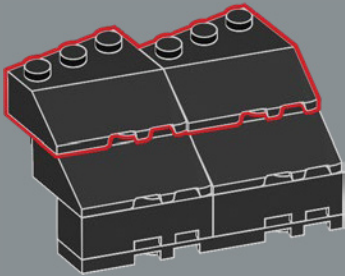

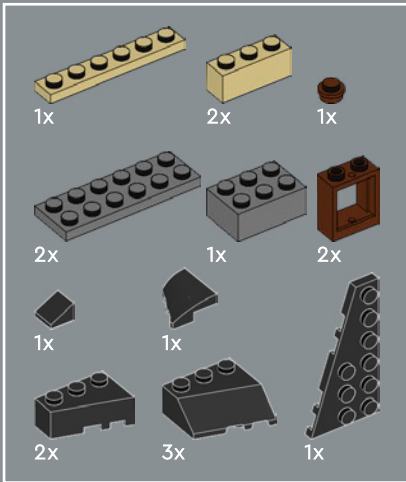
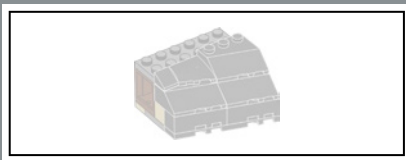

319

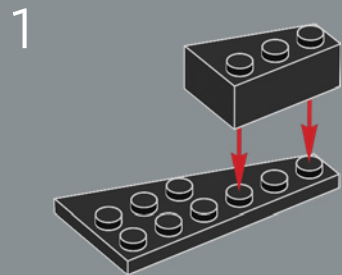

2

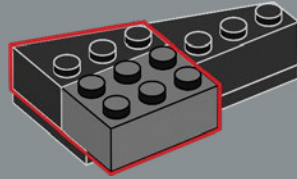

3

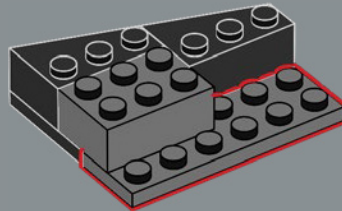

4

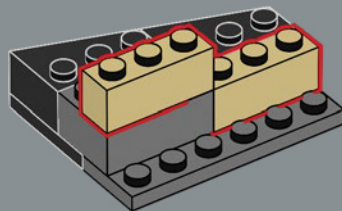

5

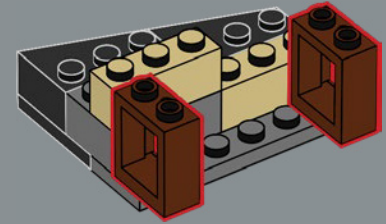

6

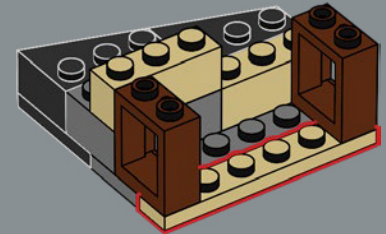

7

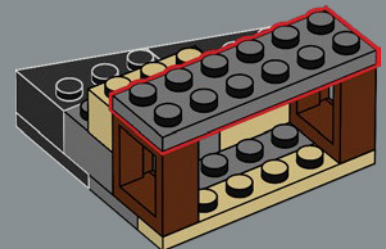

8

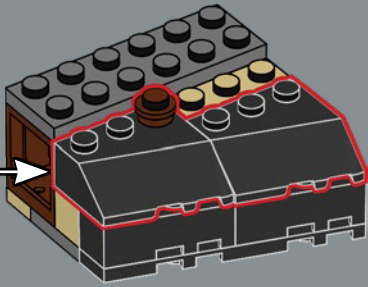
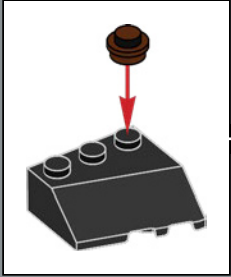

9

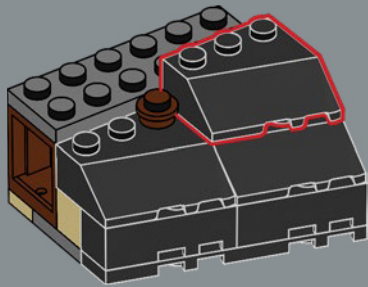

10

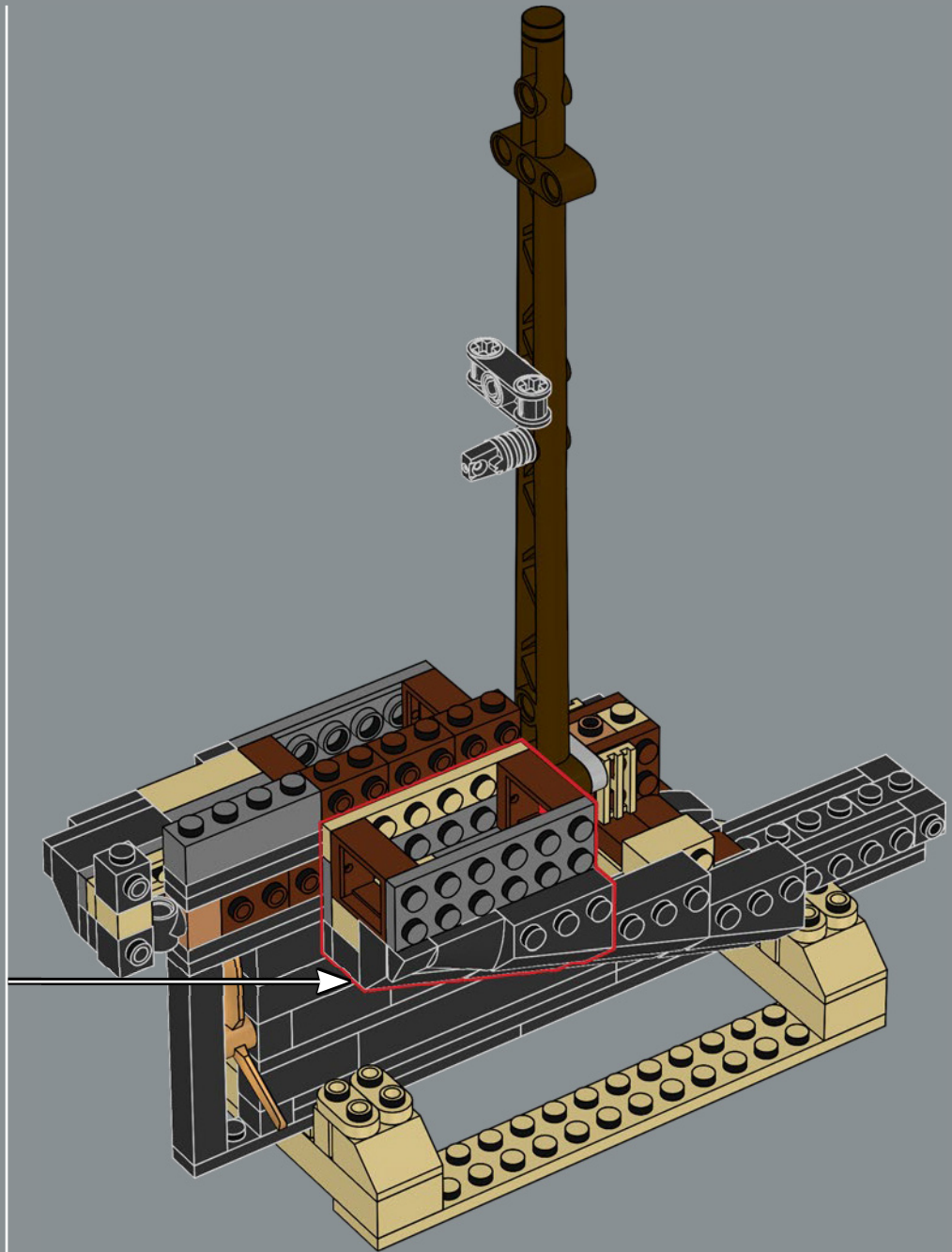
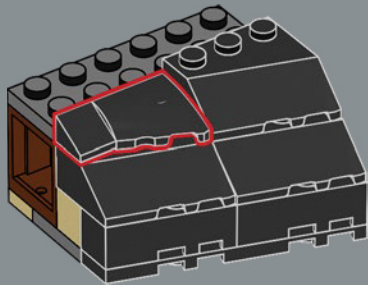

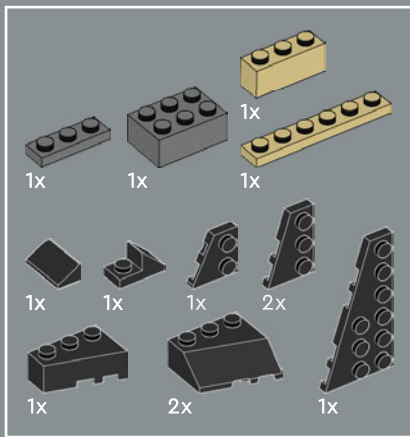

320

1

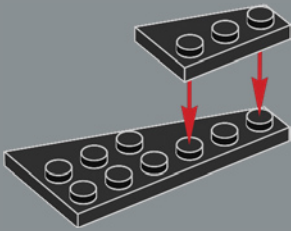

2

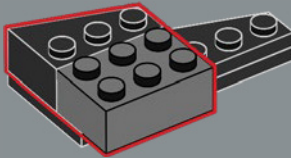

3

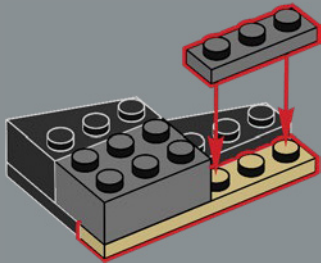

4

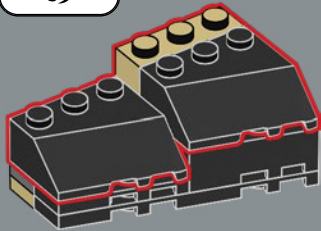

5

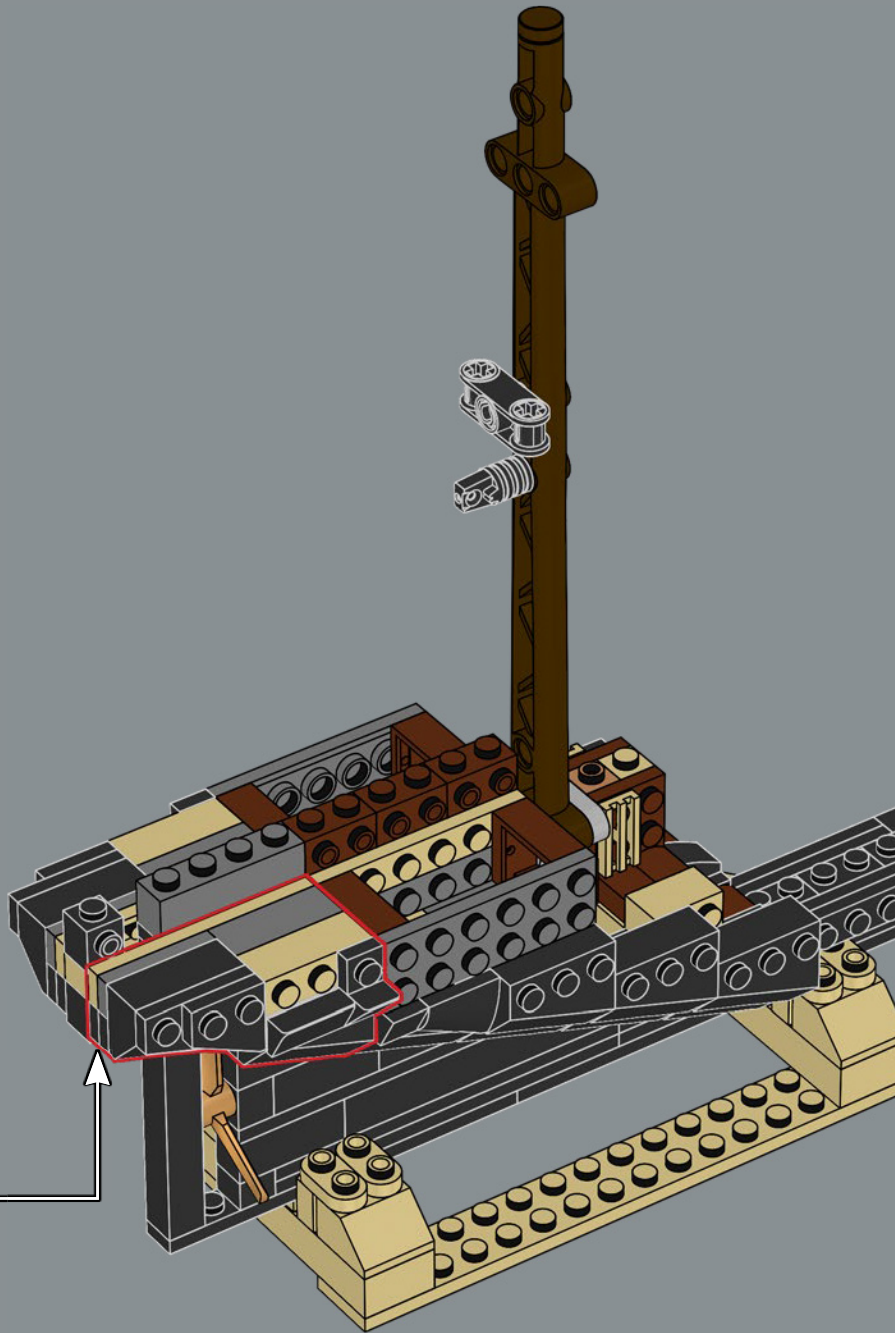
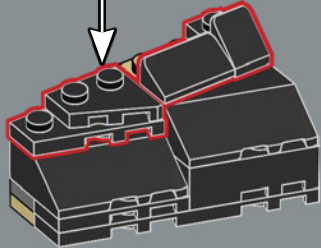
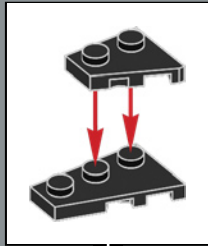

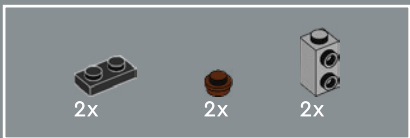

321

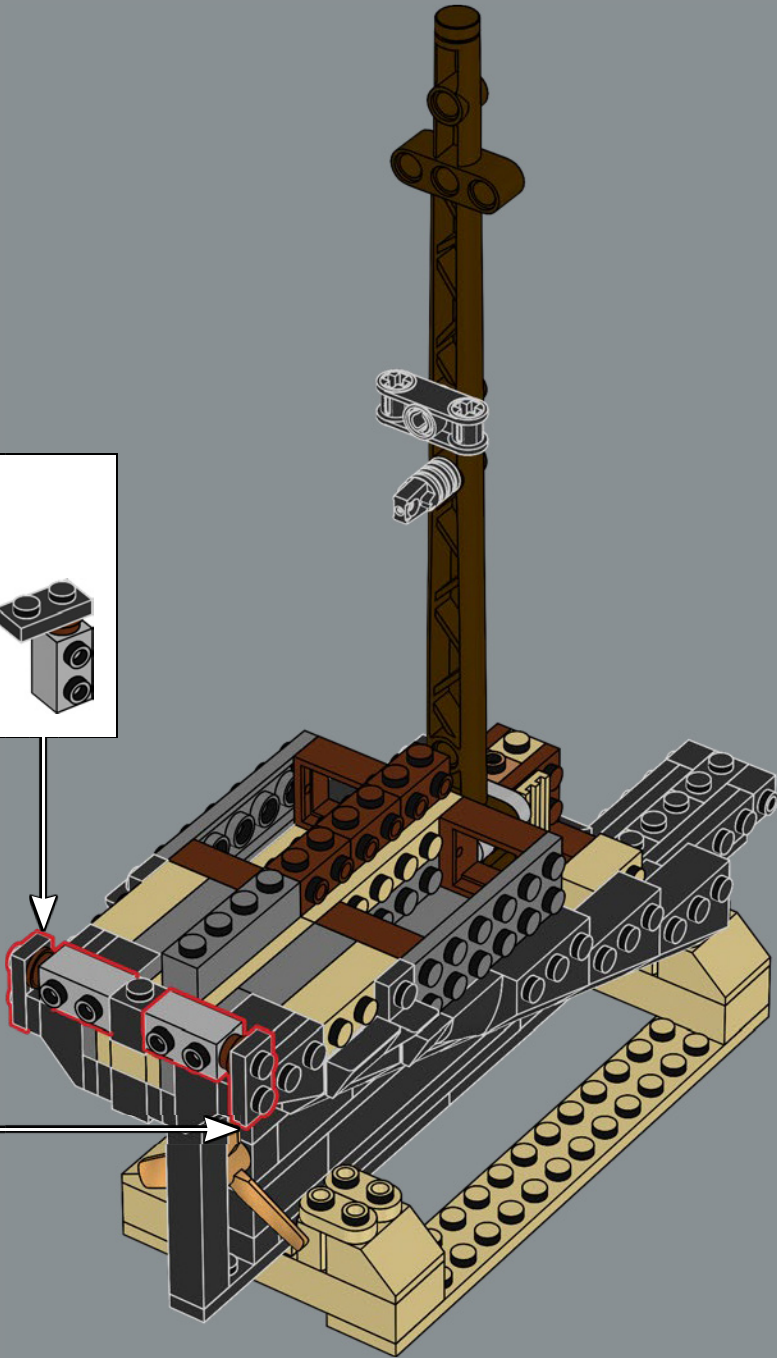
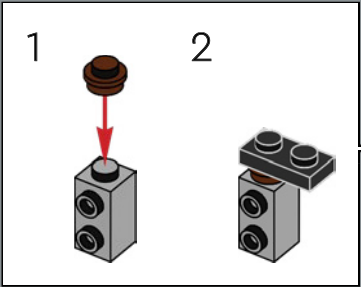
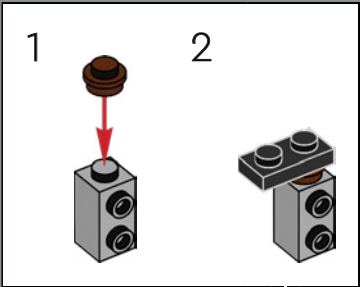

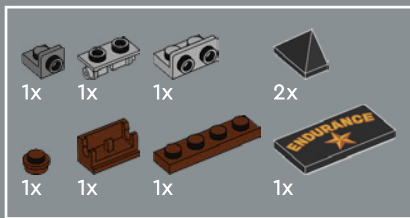

322

1

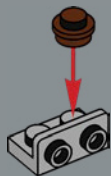

2

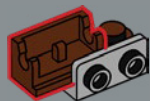

3

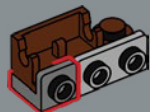

4

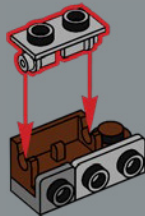

5

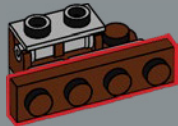

6

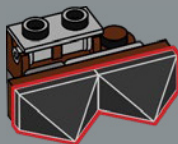

7



El nombre original del Endurance era Polaris. Se desconoce si Shackleton consideró que el nombre de la estrella que señala el norte era inapropiado para una expedición al Polo Sur o si se inspiró en el lema de su familia, "Resistiendo, venceremos" (cuya versión en inglés contiene la palabra *endurance*). En cualquier caso, ¡la estrella se quedó!

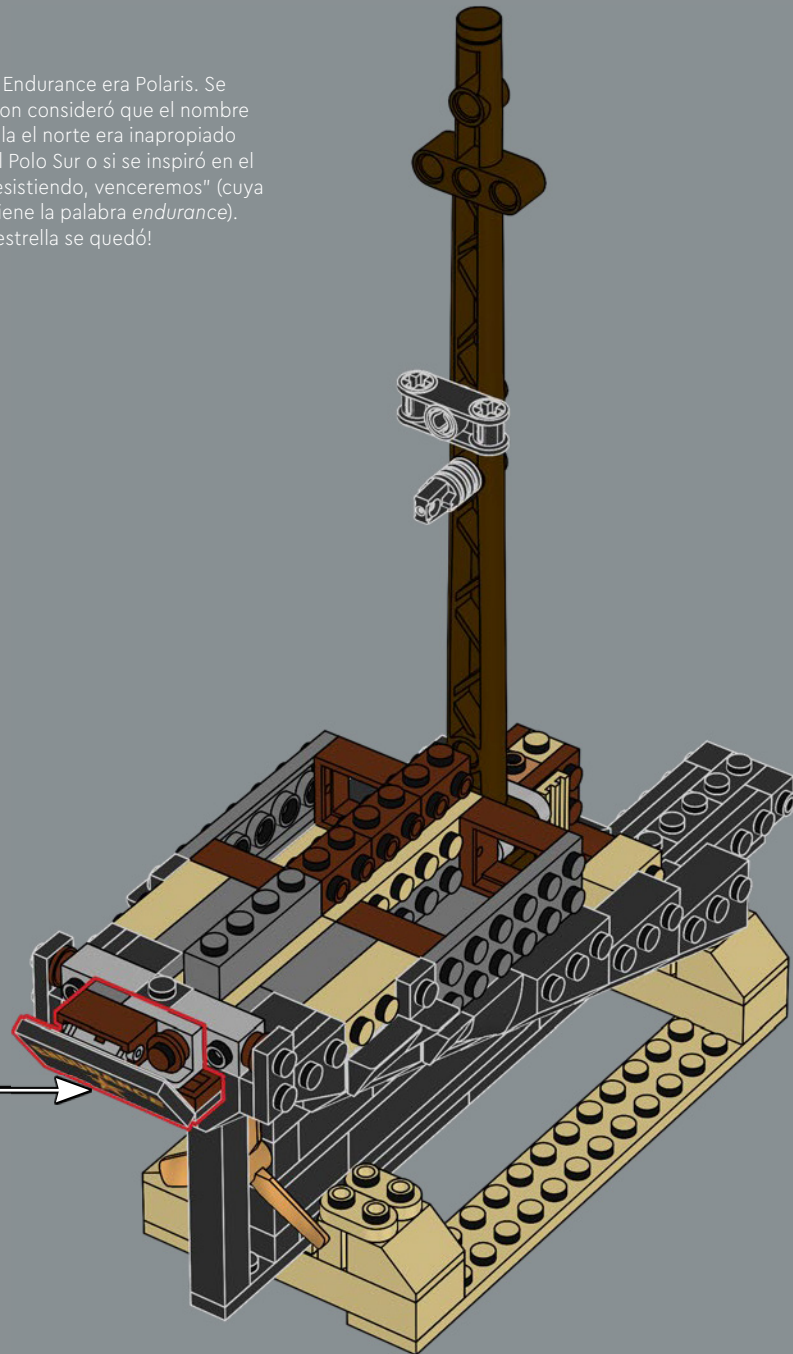

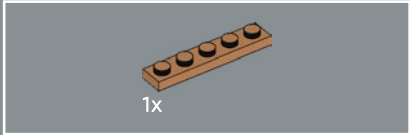
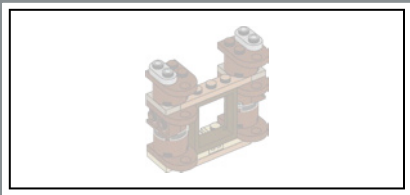

323

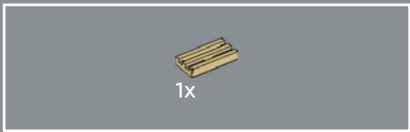
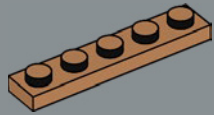

324

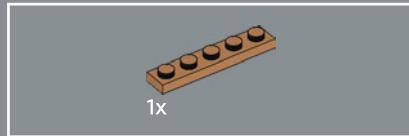
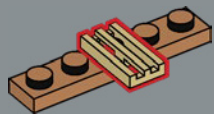

325

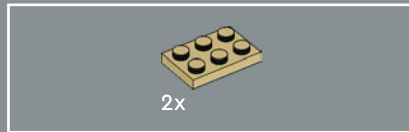
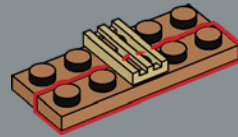

326

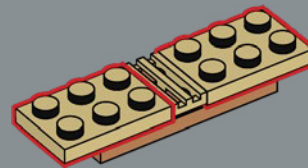

327

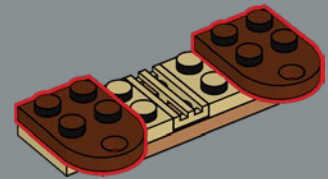

328

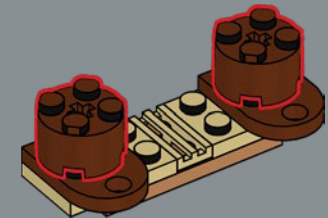



329

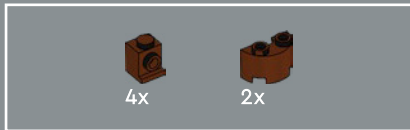
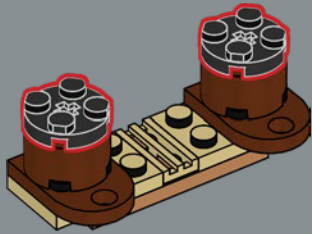

330

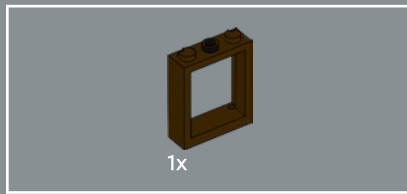
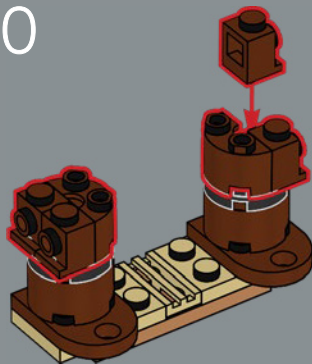

331

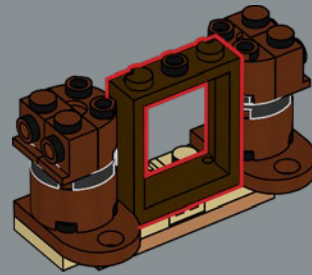

332

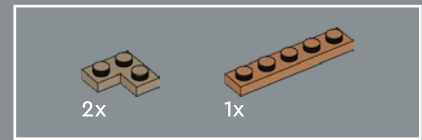
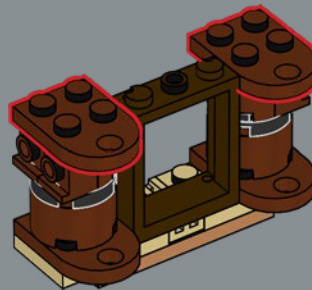

333

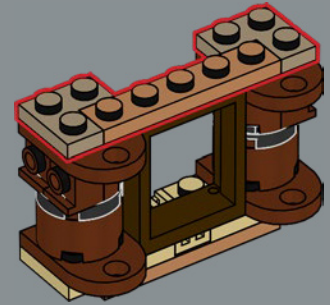

334

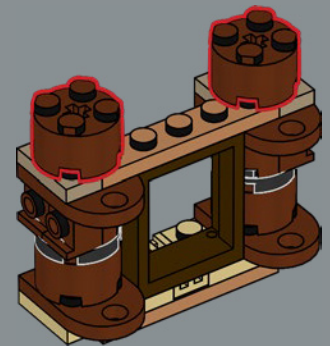



335

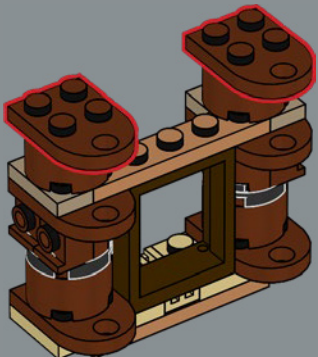

336

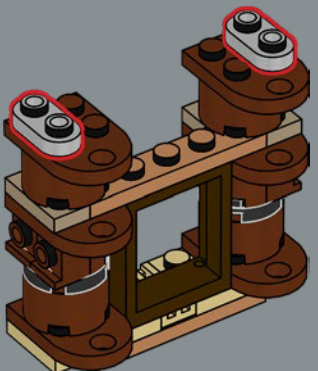

337

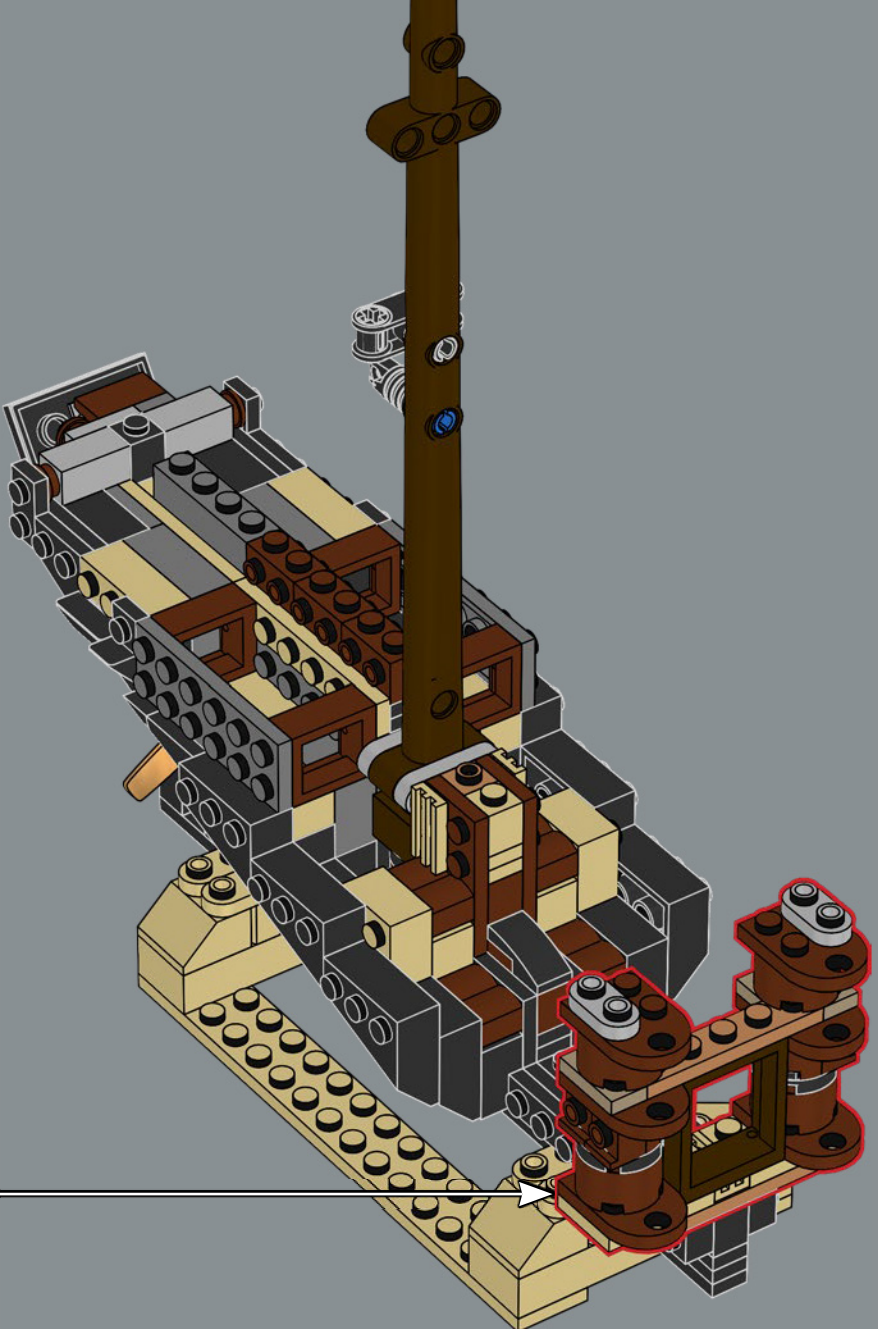

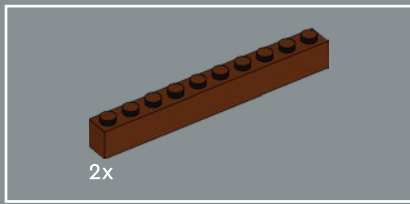

338

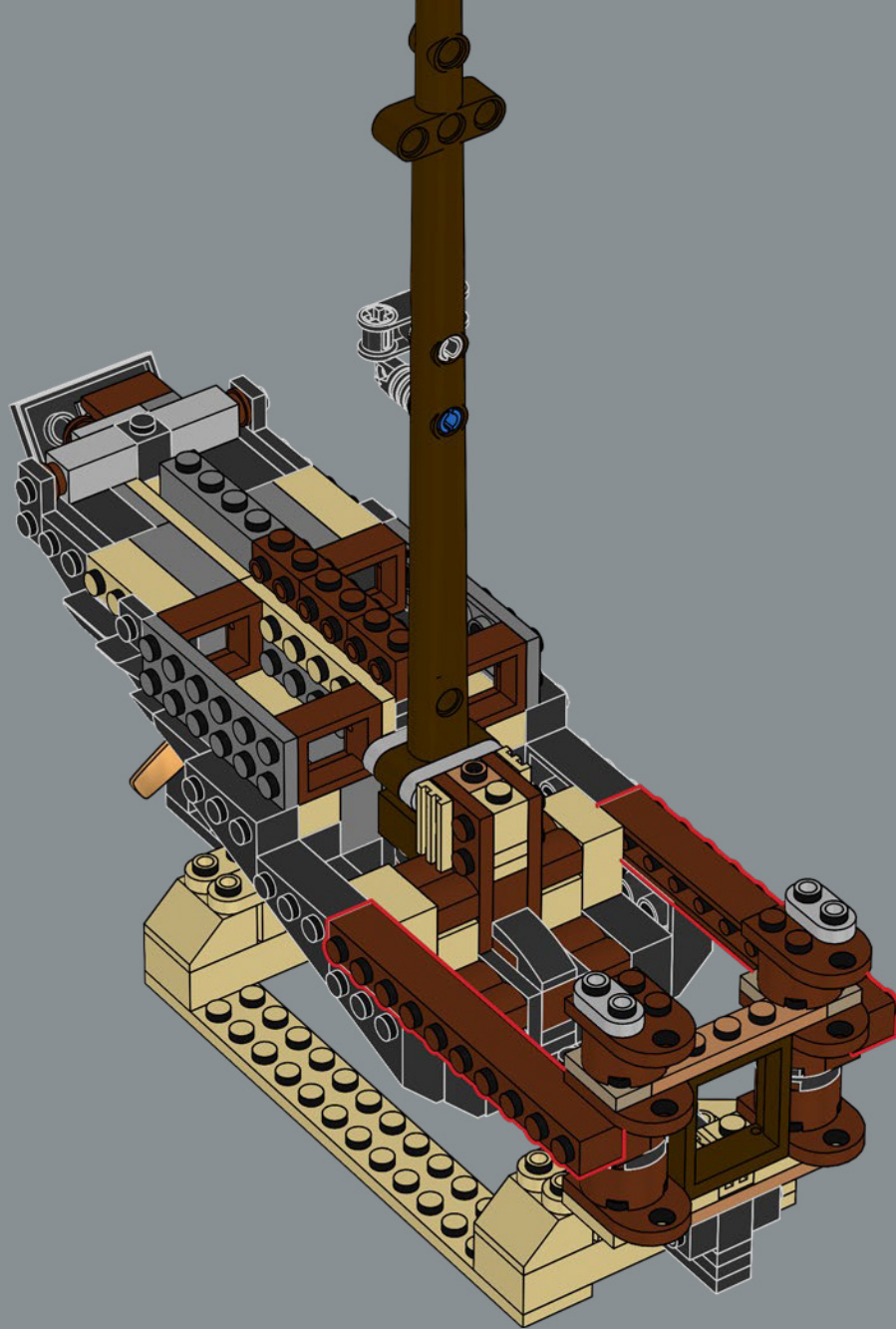

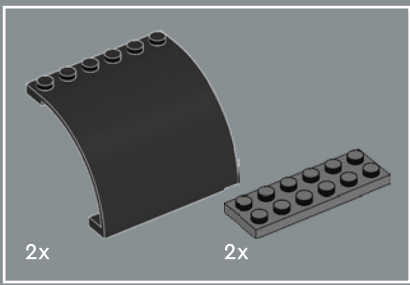

339

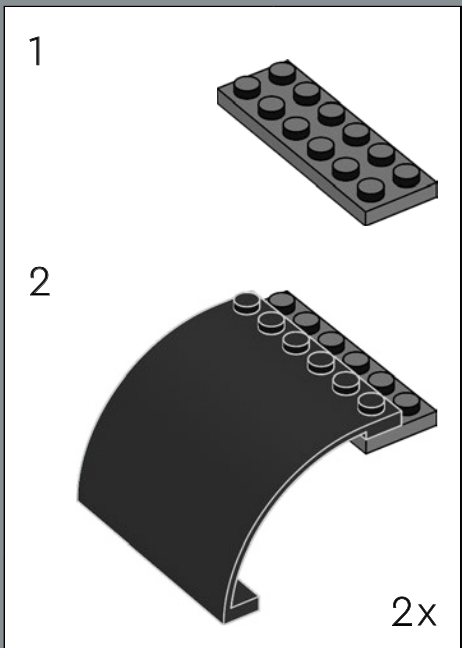
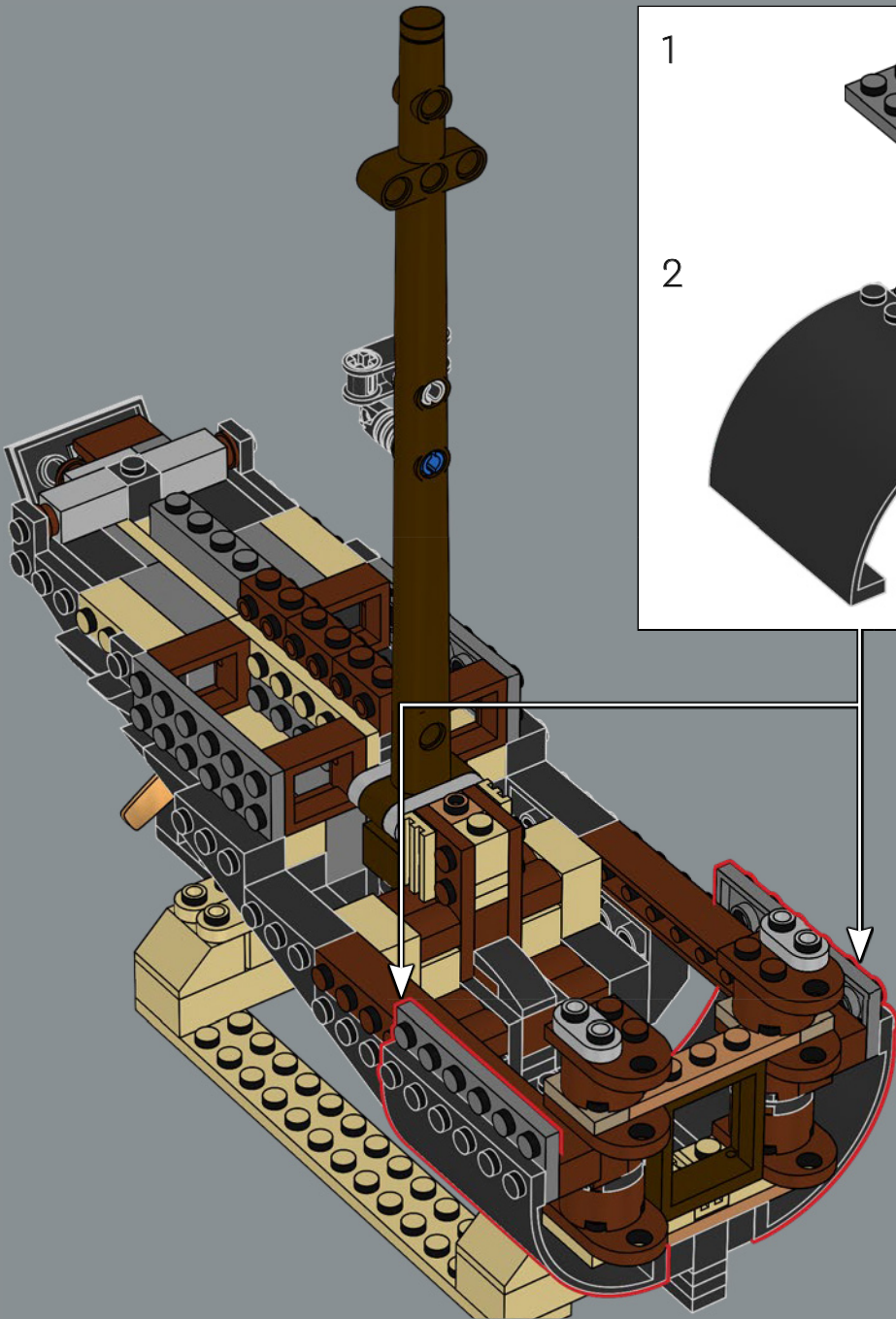

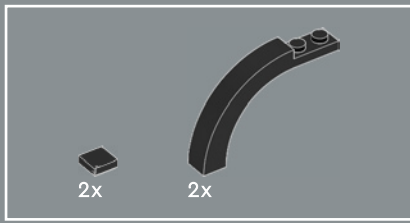

340

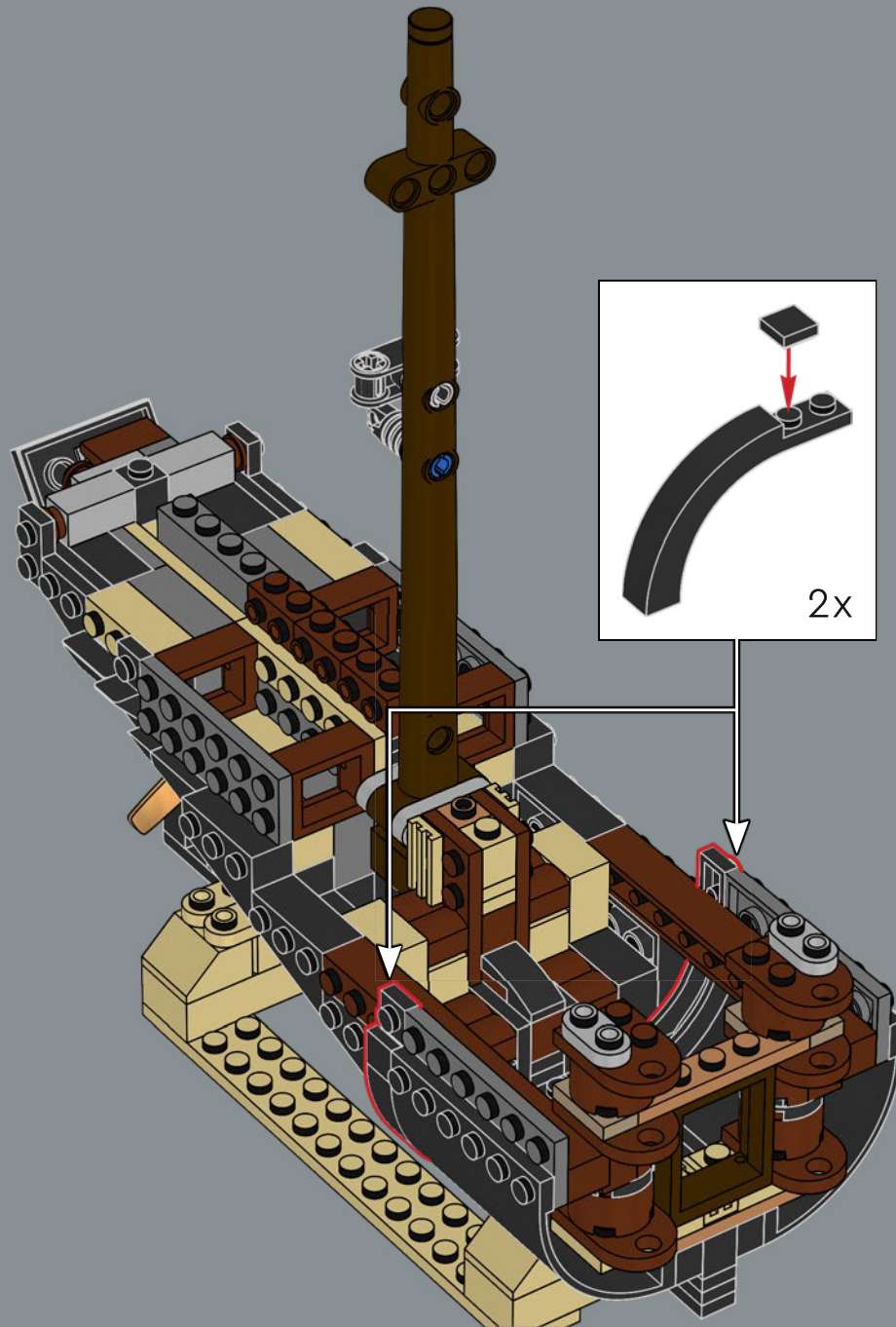

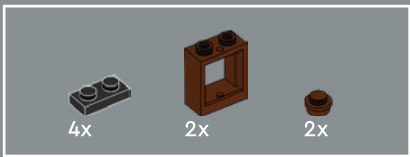

341

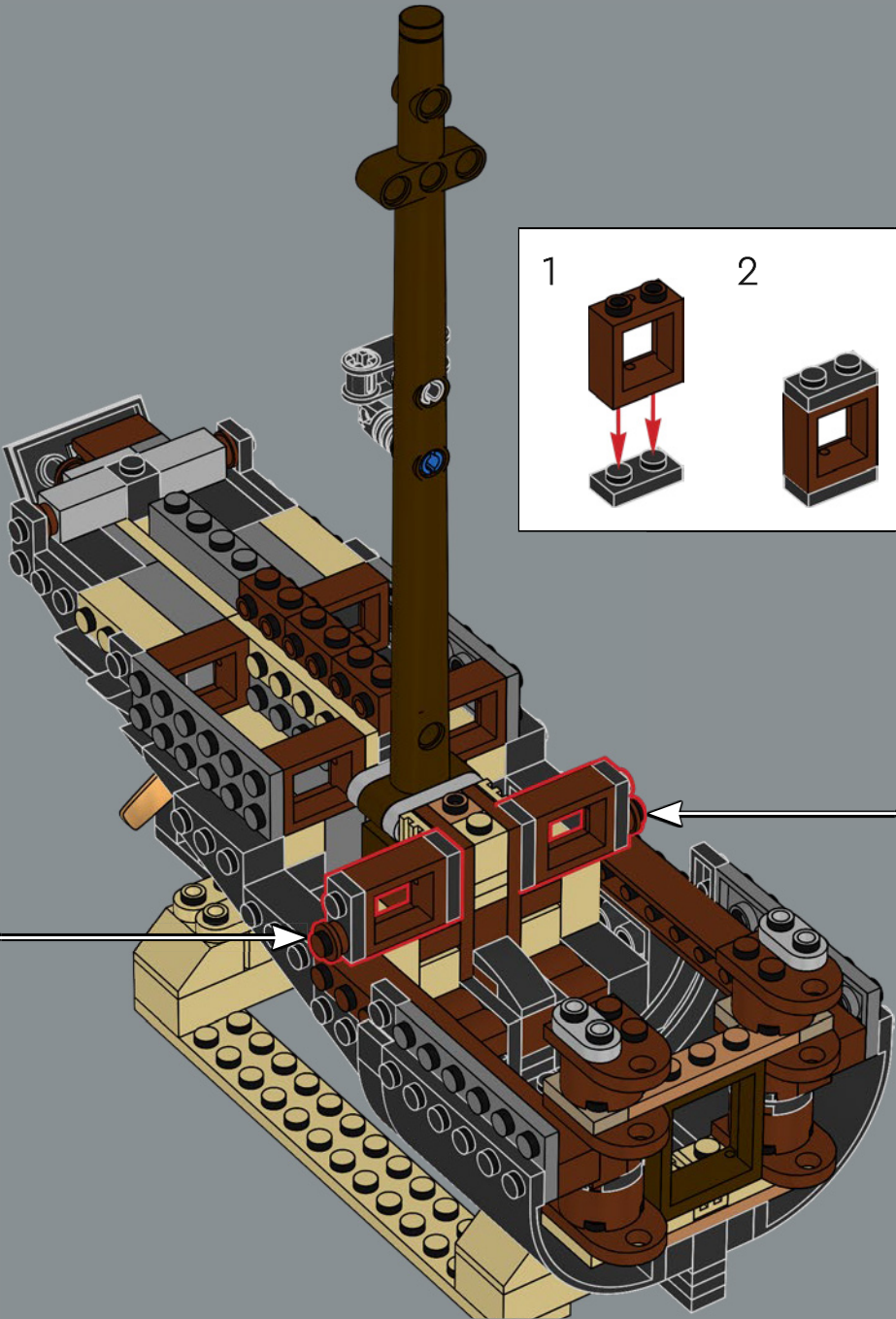
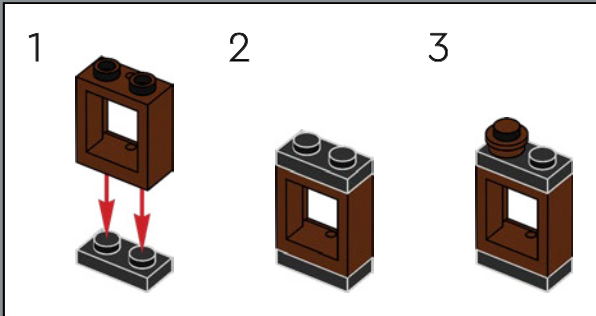
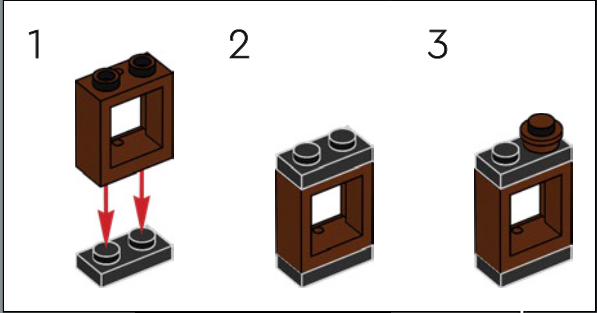

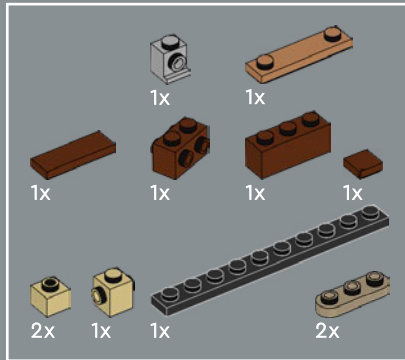
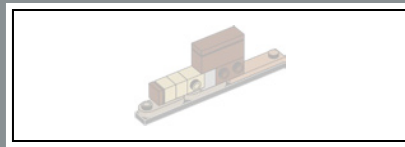

342

1

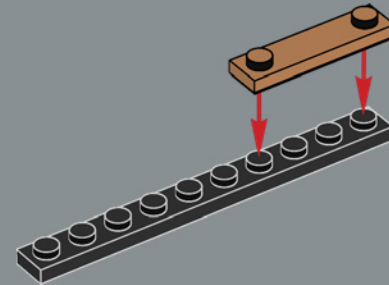

2

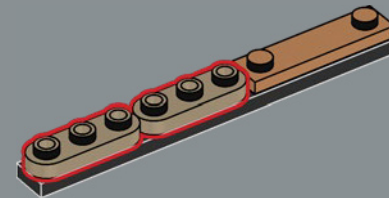

3

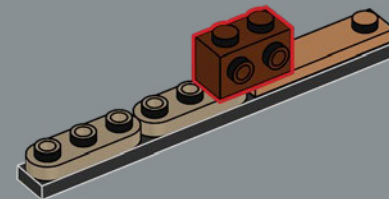

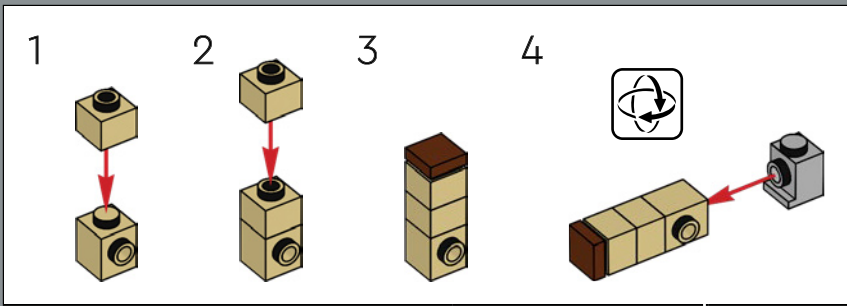

4

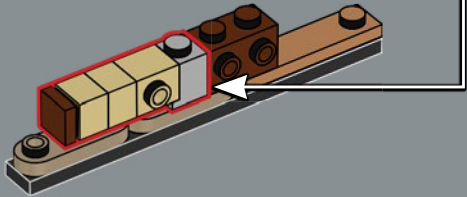

5

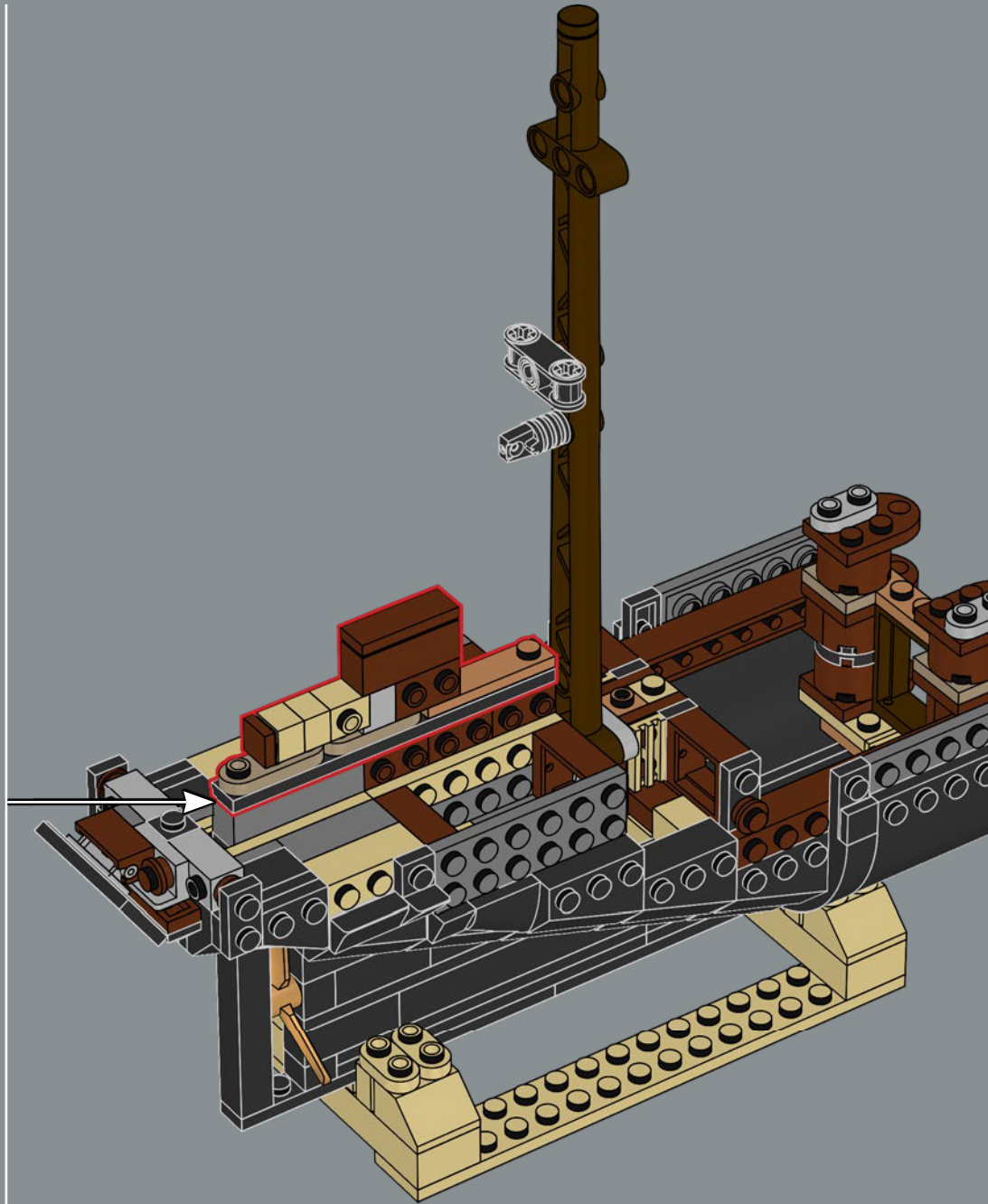
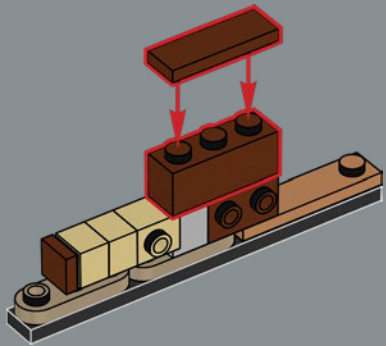

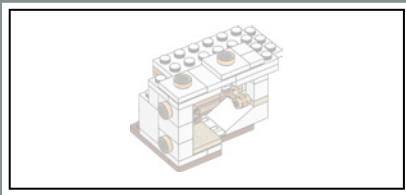

343

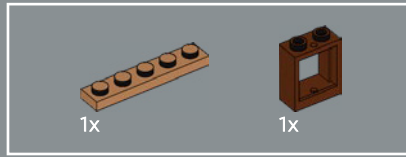
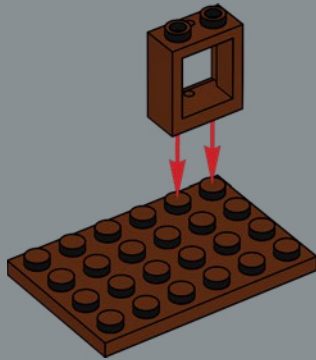

344

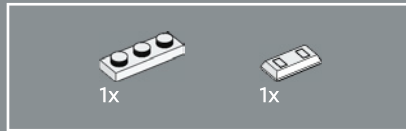
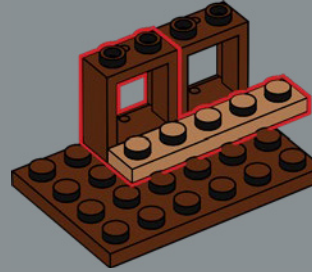

345

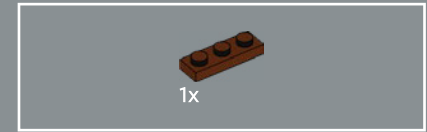
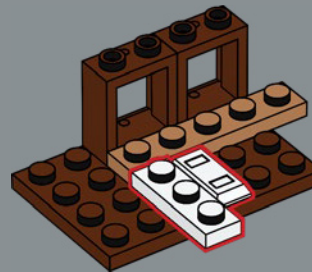

346

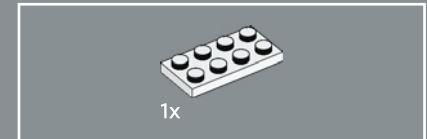
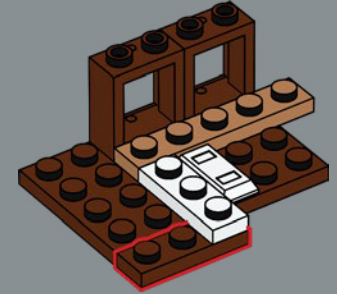

347

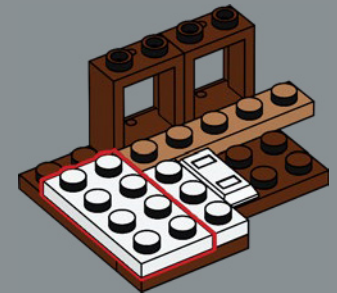

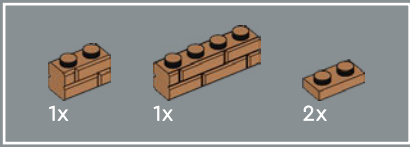

348

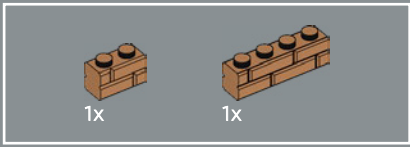
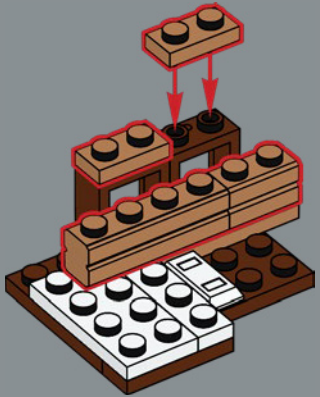

349

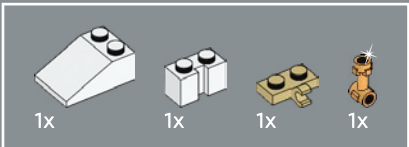
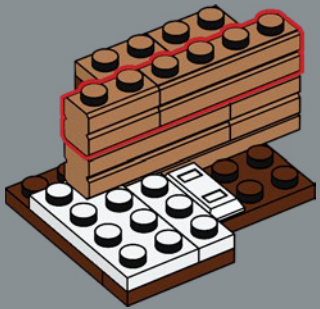

350

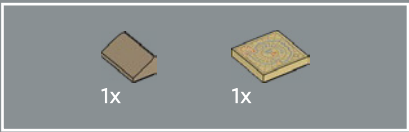
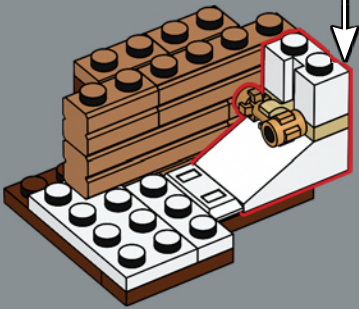
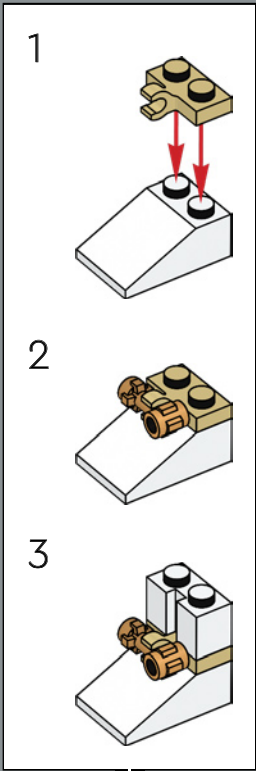

351

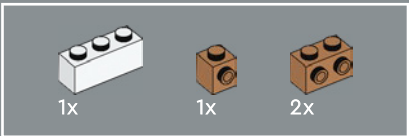
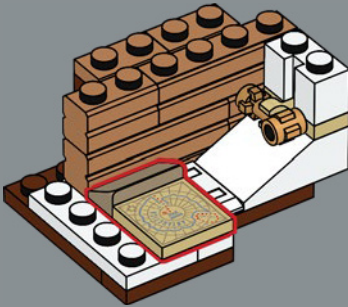

352

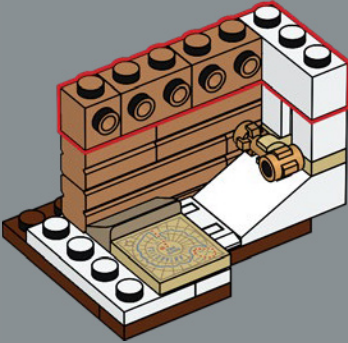

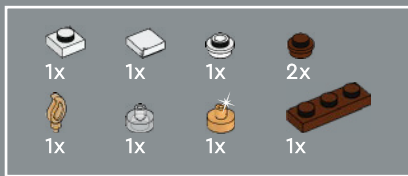

353

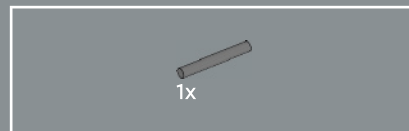
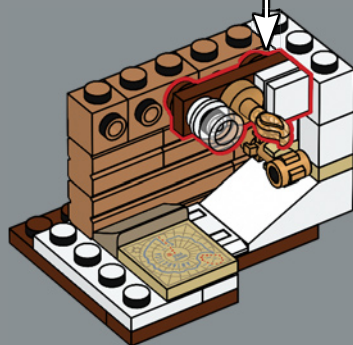
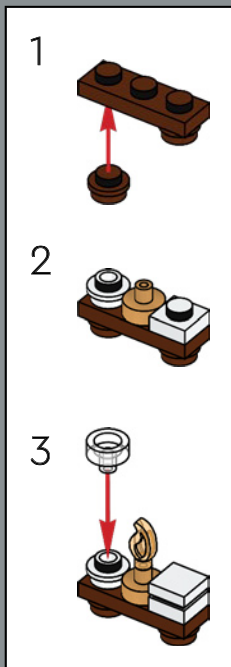

354

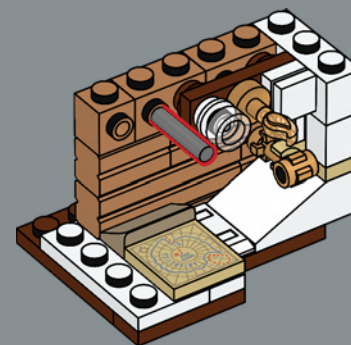

Los palitos en gris oscuro que atraviesan verticalmente los camarotes representan tuberías de vapor para calefacción. El camarote del científico incluye un exclusivo mapa LEGO® de la Antártida.

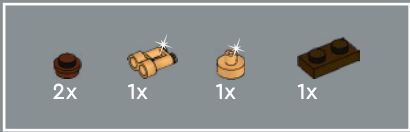

355

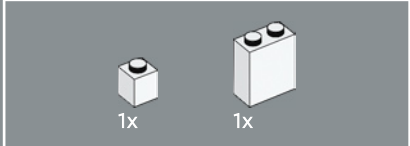
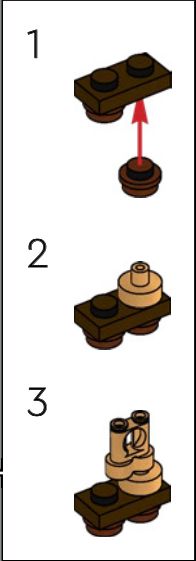
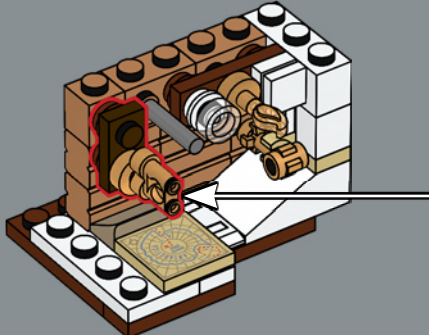

356

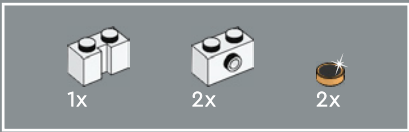
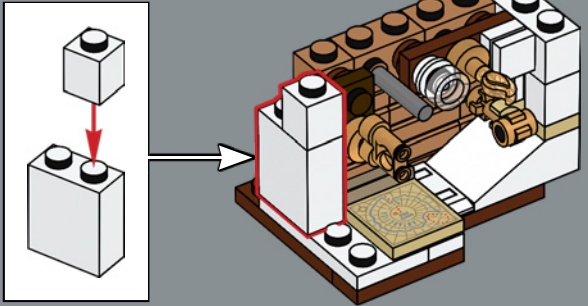

357

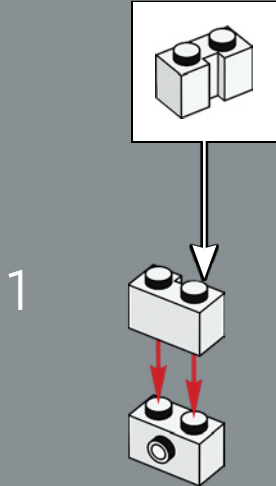

2

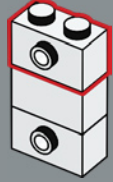

3

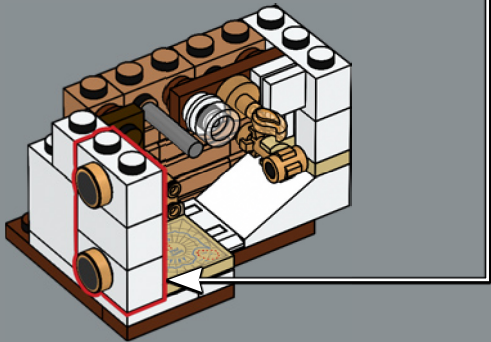
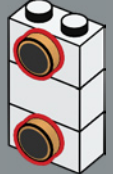

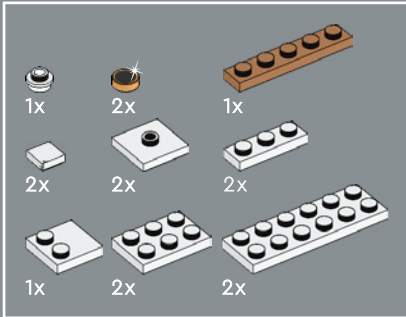
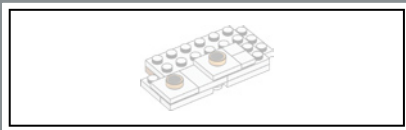

358

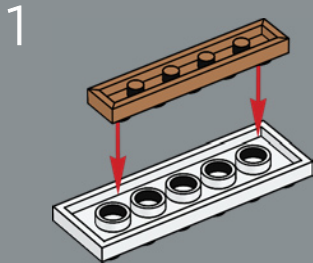

2

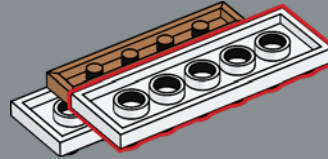

3

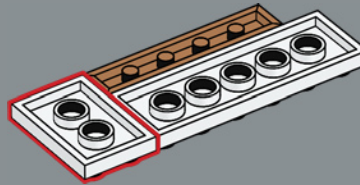

4

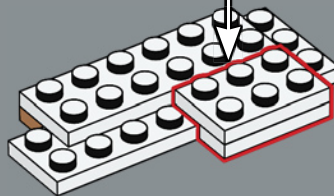
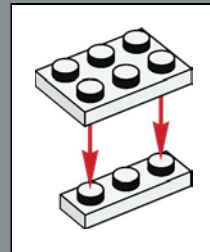

5

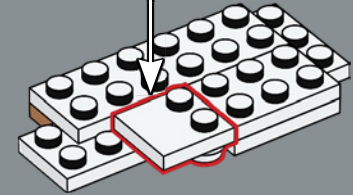
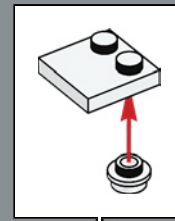

6

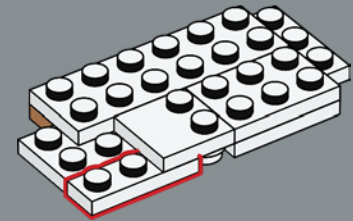

7

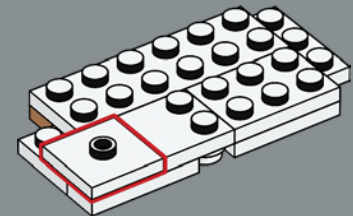

8

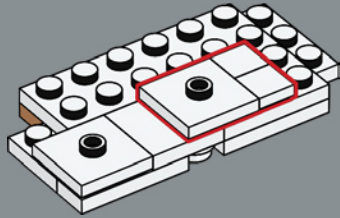

9

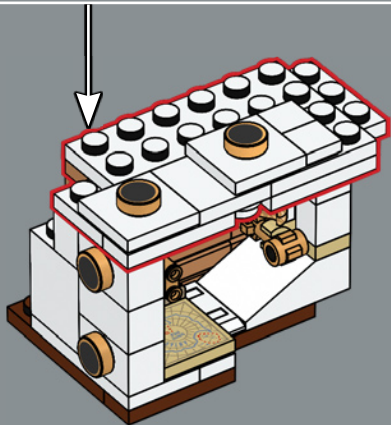
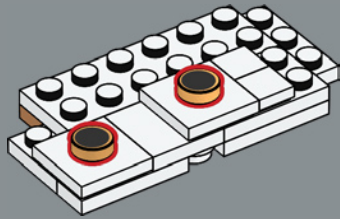

359

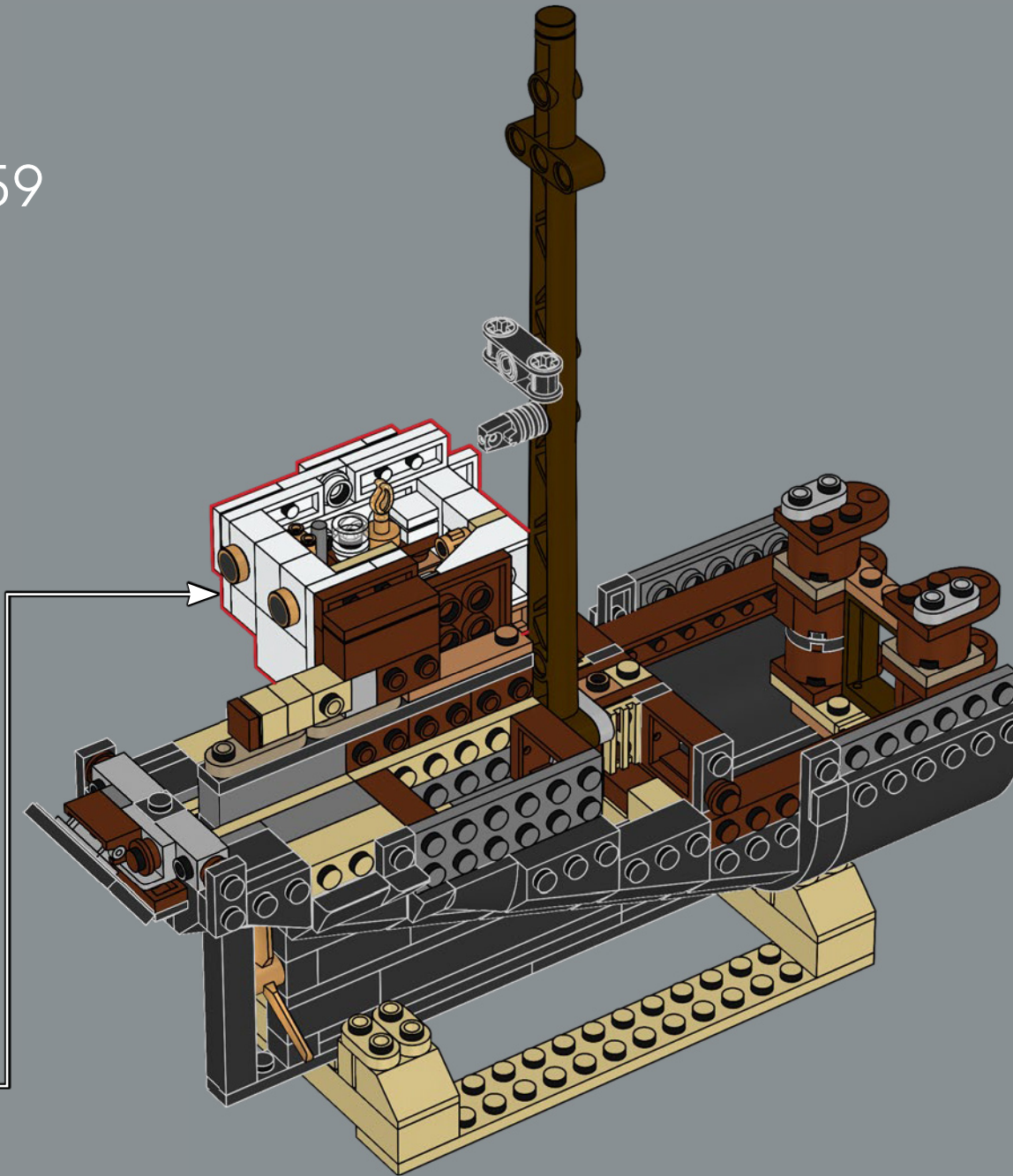

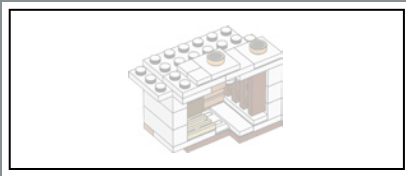

360

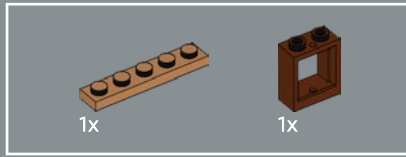
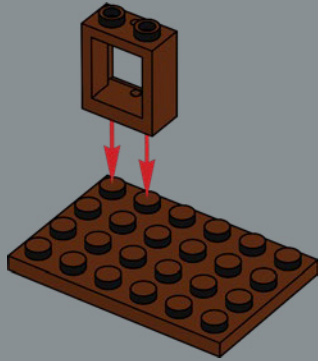

361

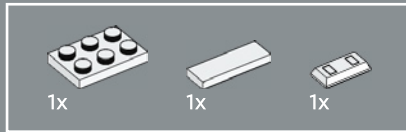
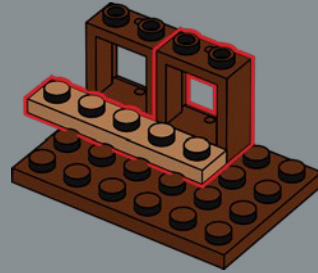

362

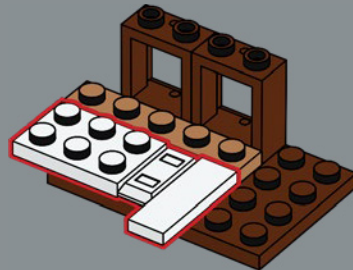

363

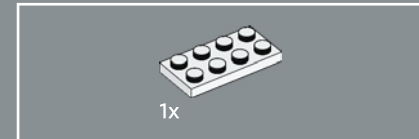
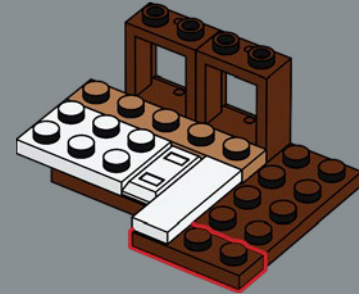

364



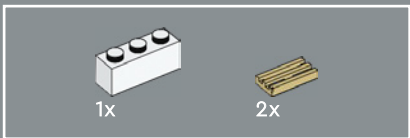

365

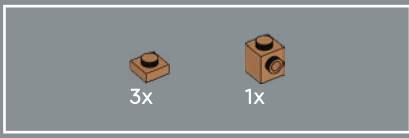
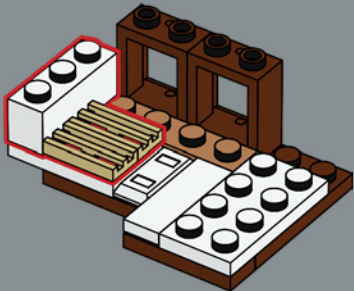

367

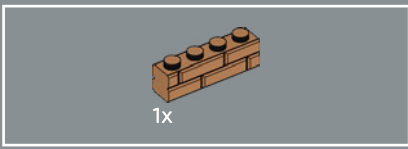
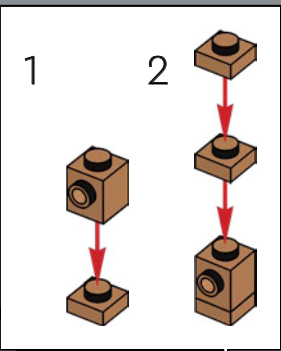
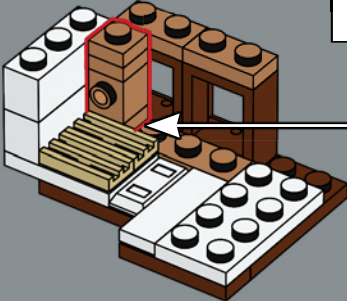

369

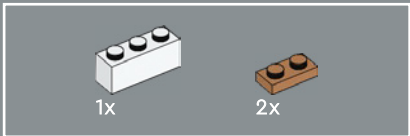
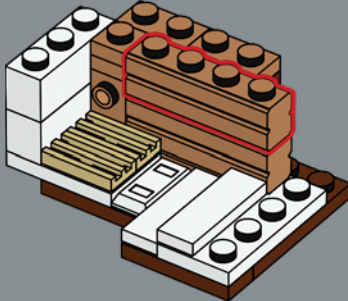

366

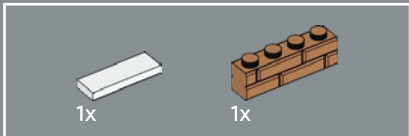
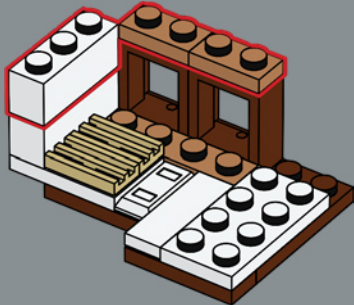

368

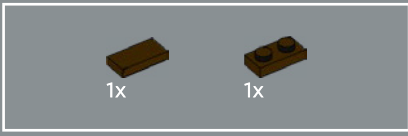
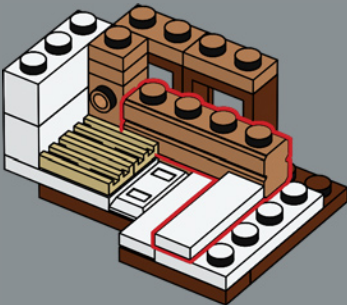

370

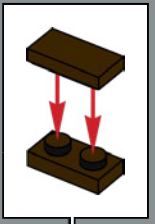
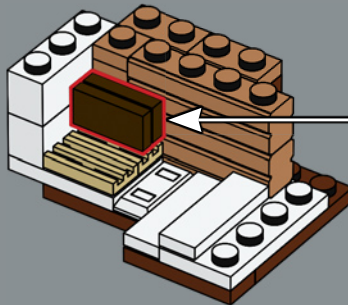

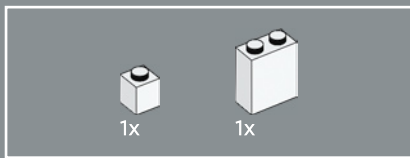

371

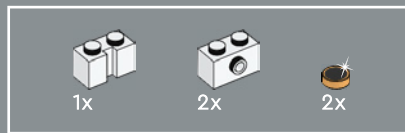
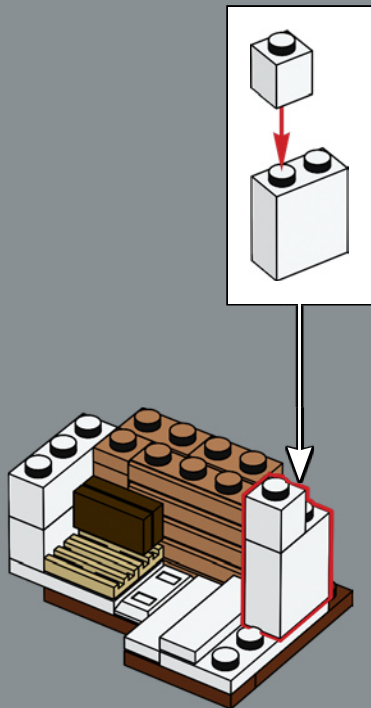

372

1

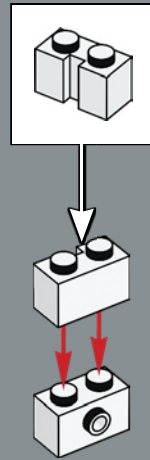

2

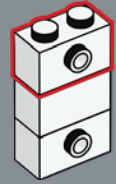

3

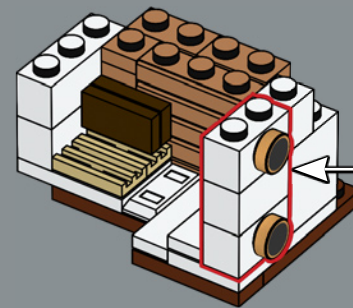
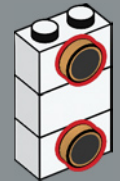

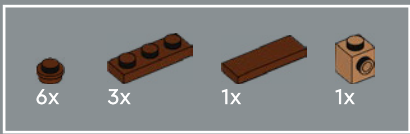

373

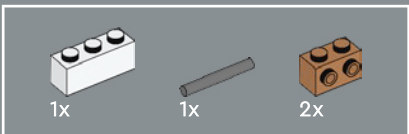
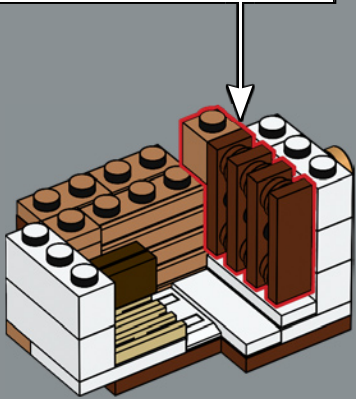
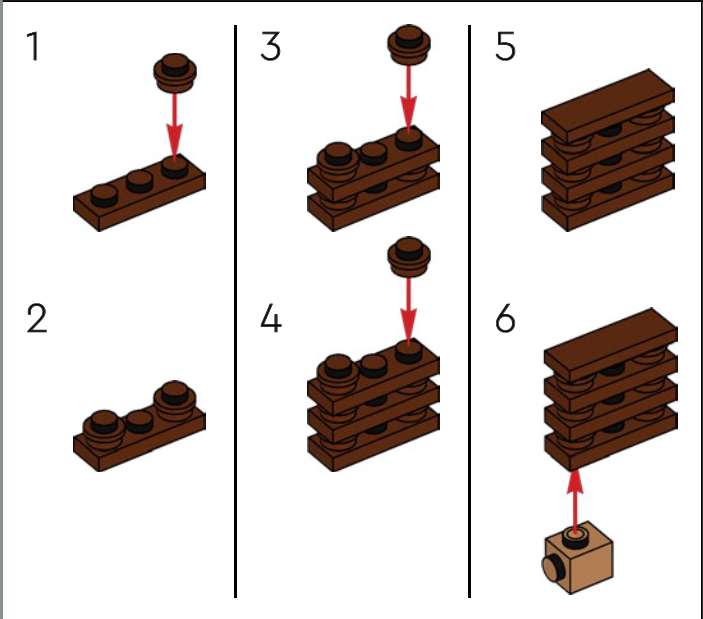

374

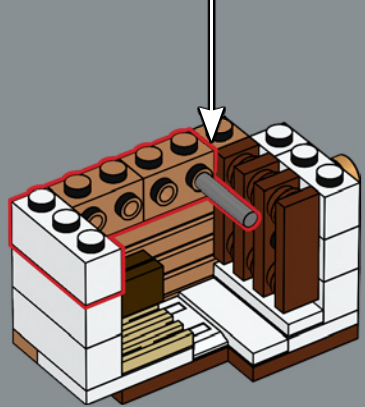
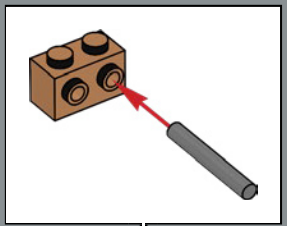

375

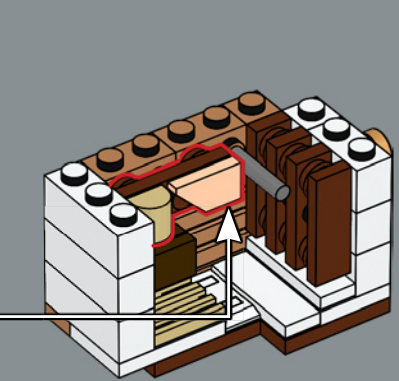
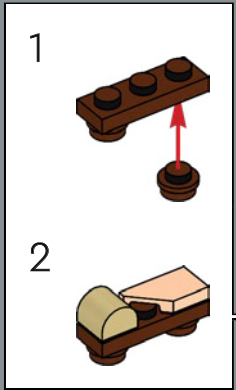

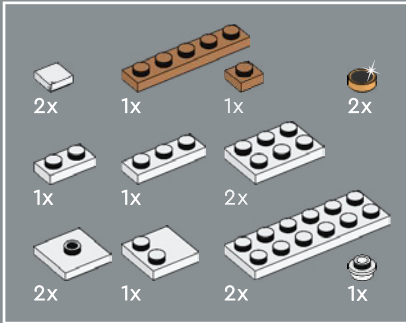
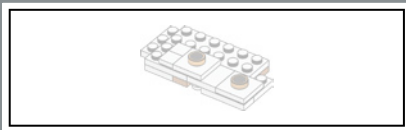

376

1

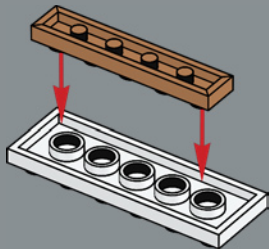

2

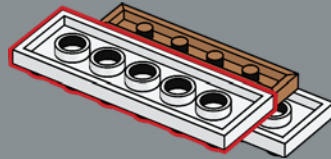

3

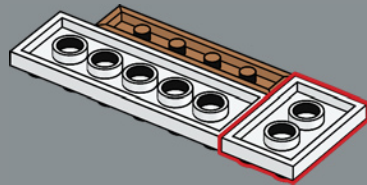

4

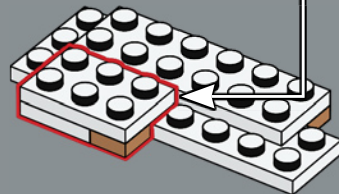
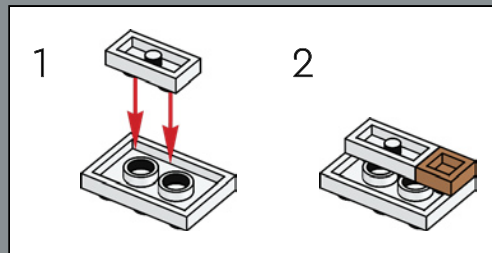

5

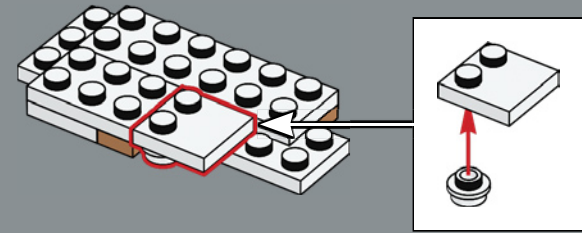

6

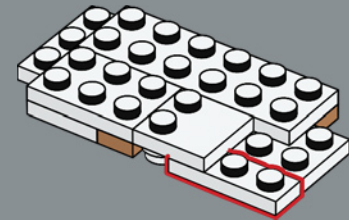

7

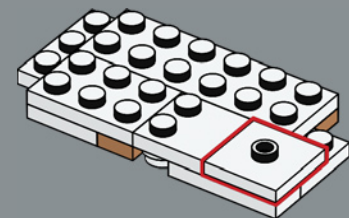

8

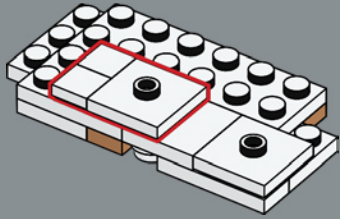

9

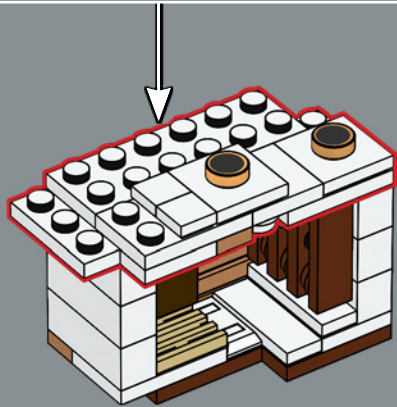
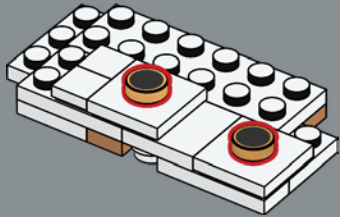

377

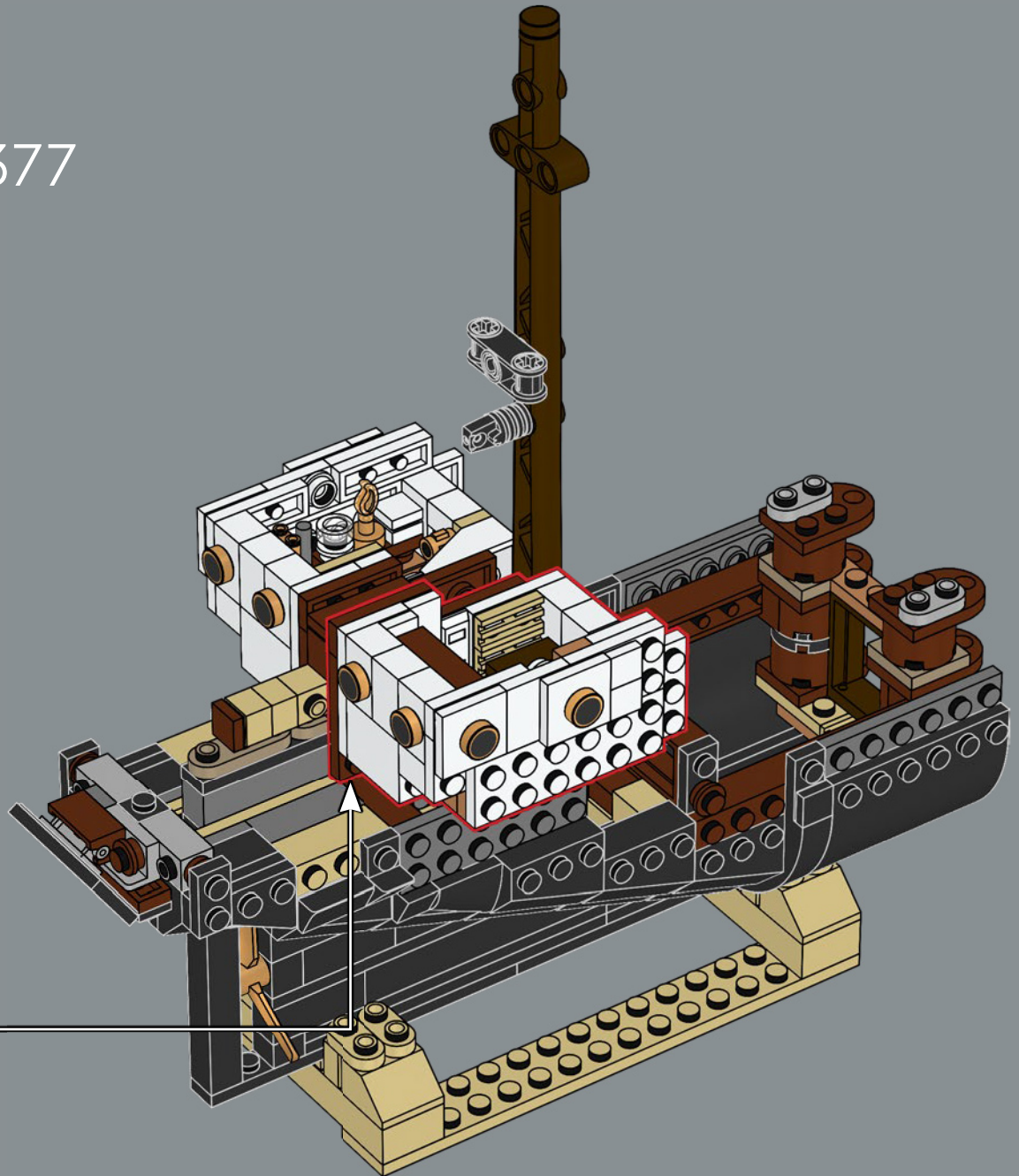

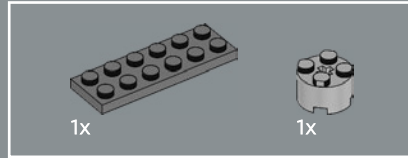
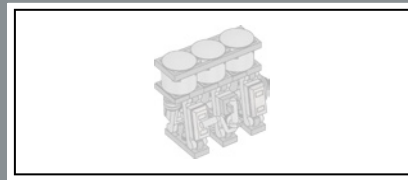

378

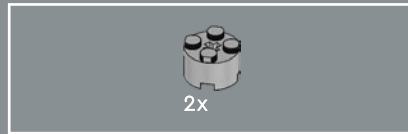
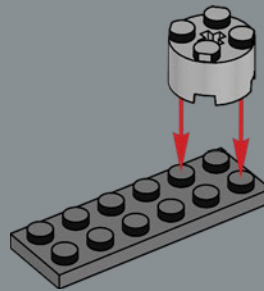

379

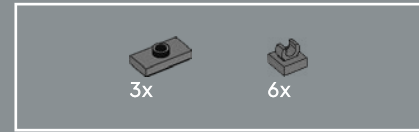
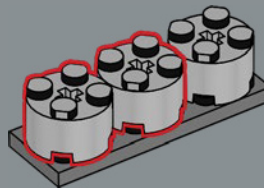

380

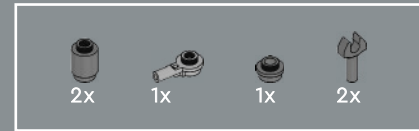
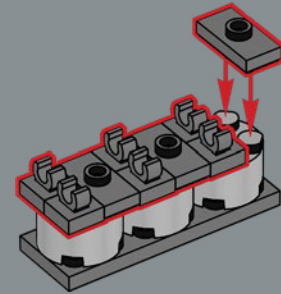

381

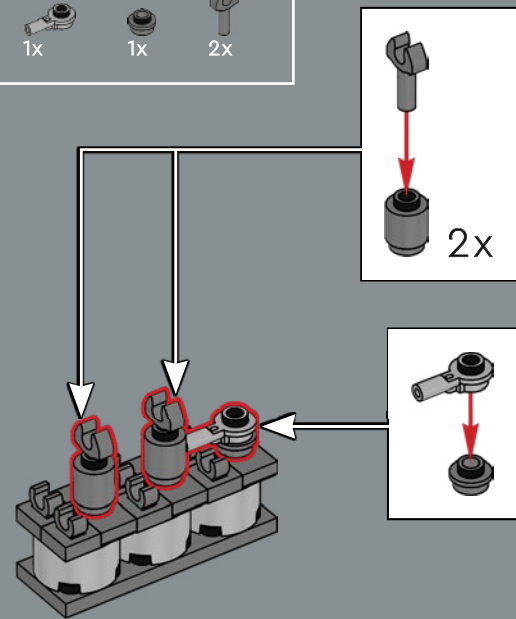

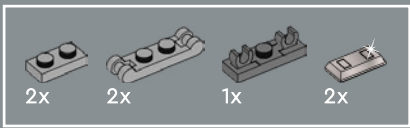

382

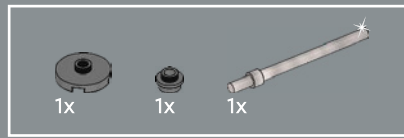
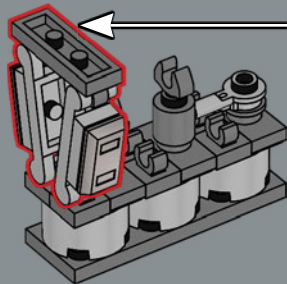
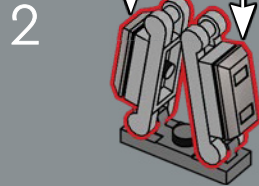
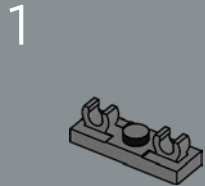
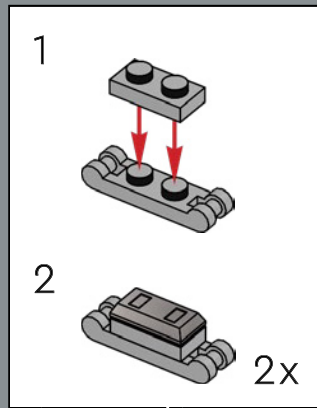

383

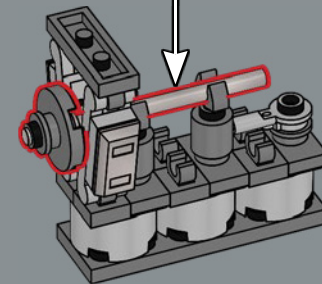
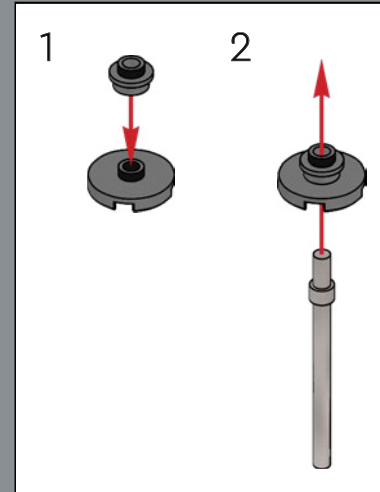

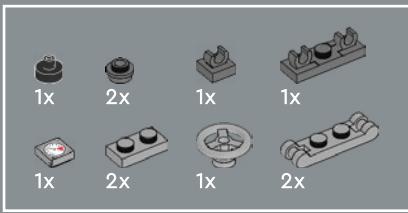

384

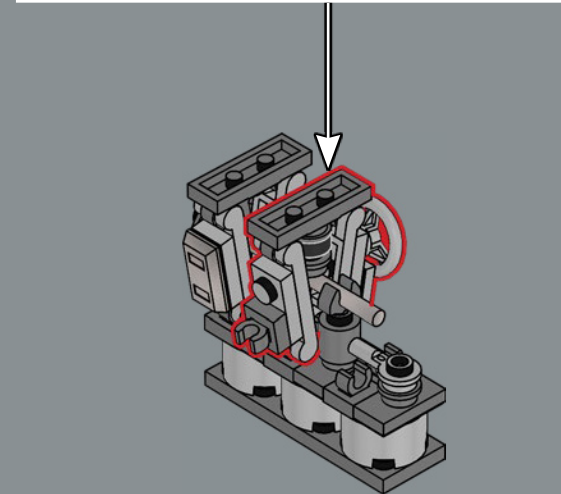
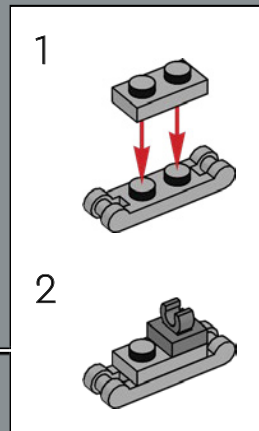
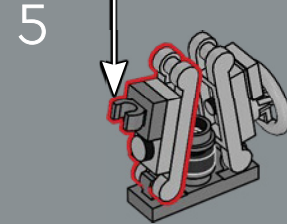
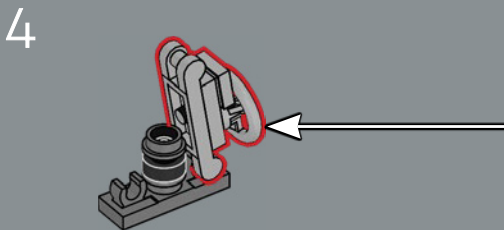
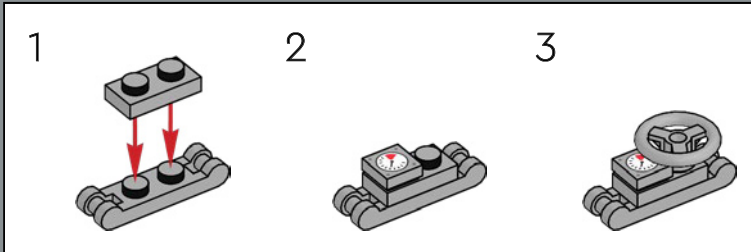
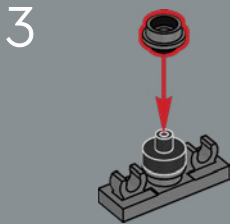
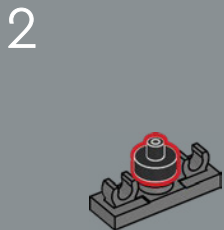
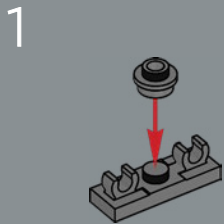

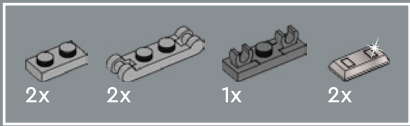

385

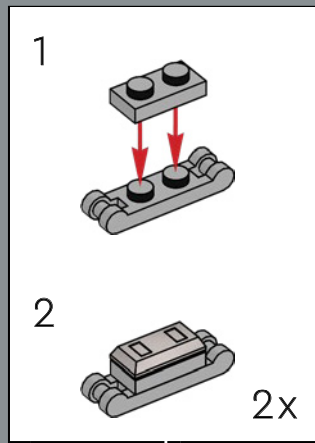

1

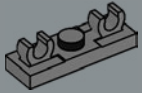

2

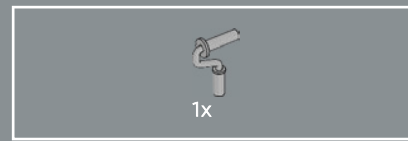
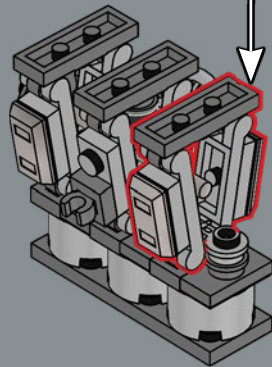
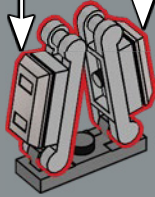

386

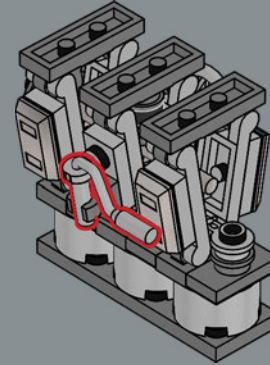

387

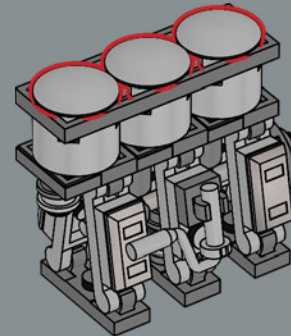



La máquina de vapor de triple expansión se puede extraer de la sala de máquinas para exponerla aparte.

388

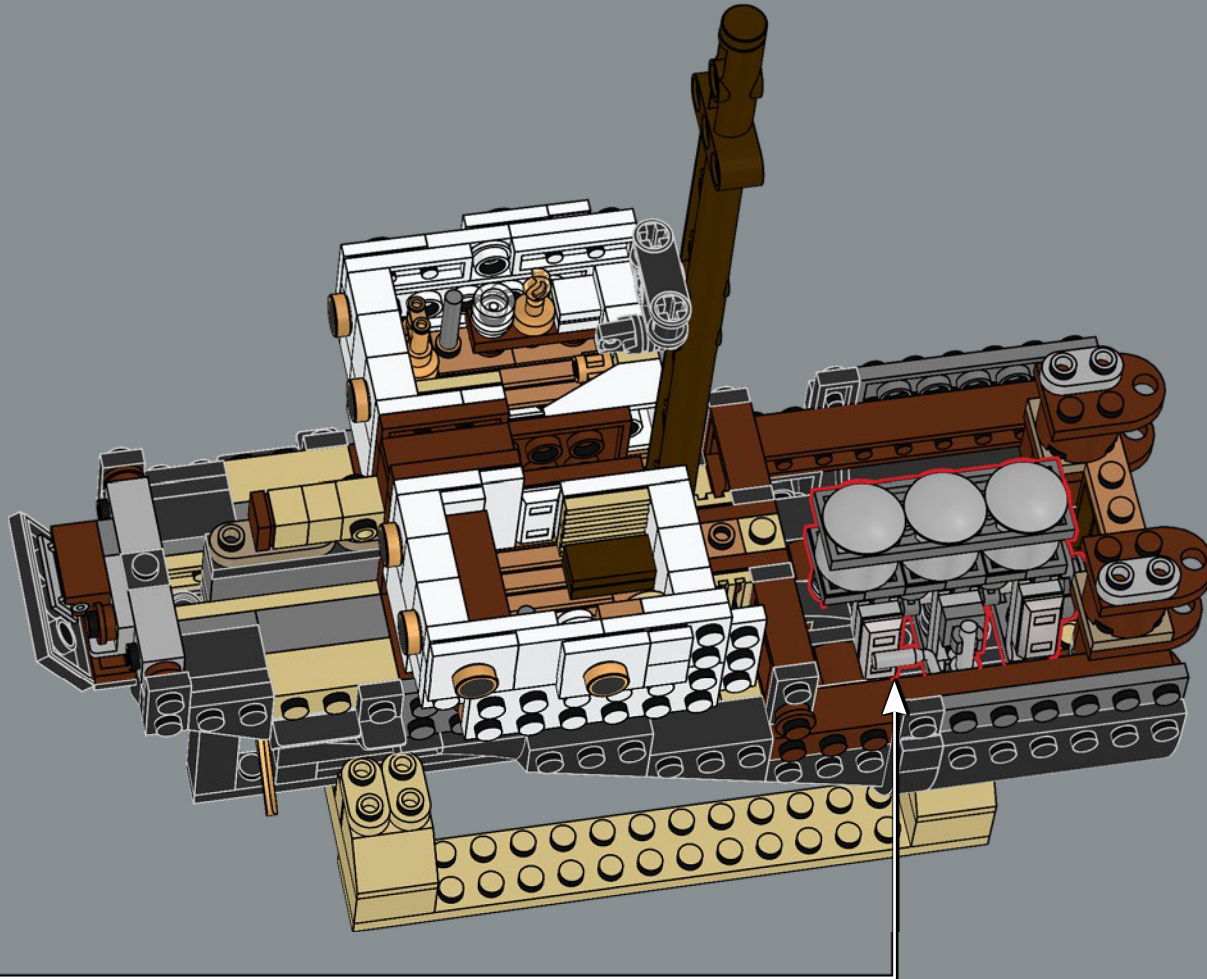

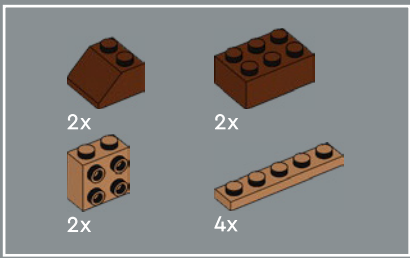

389

1



2

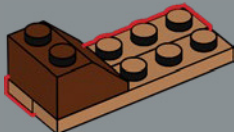

3

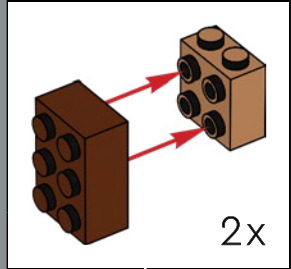
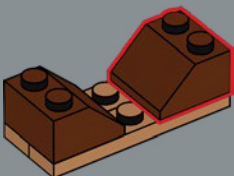

4

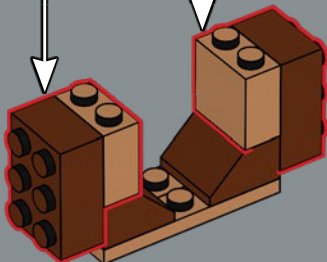

5

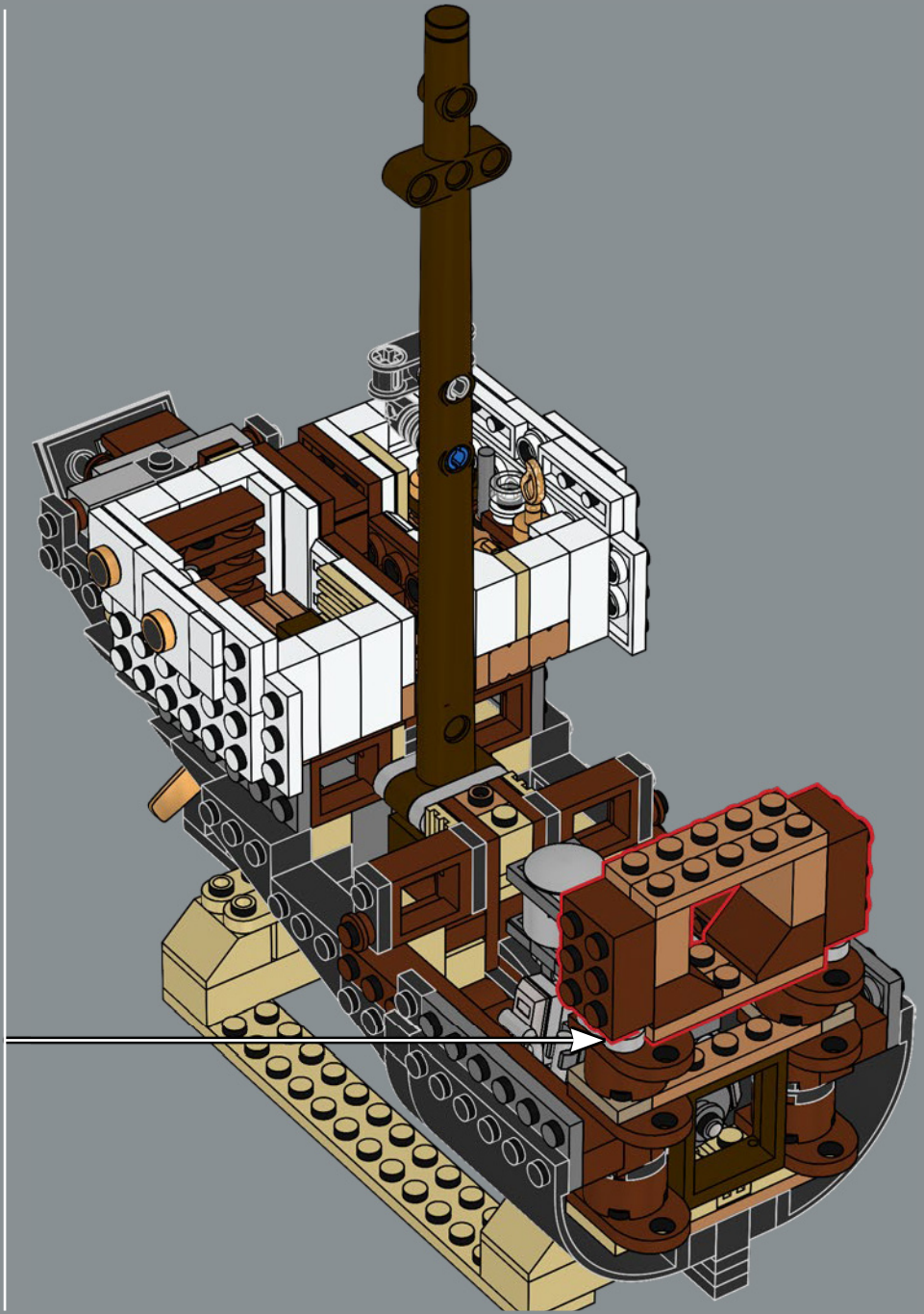
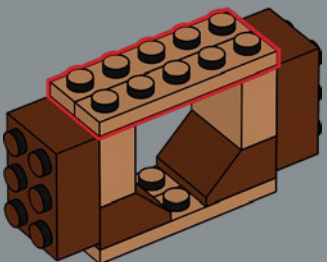

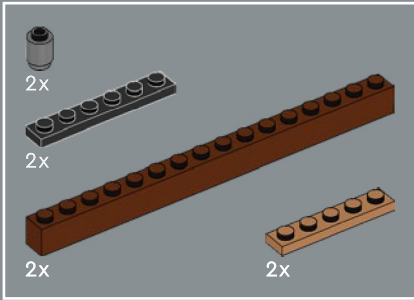
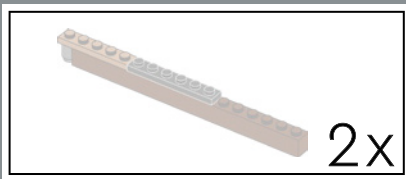

390

1

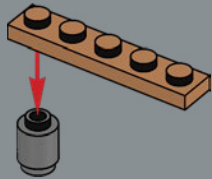

2

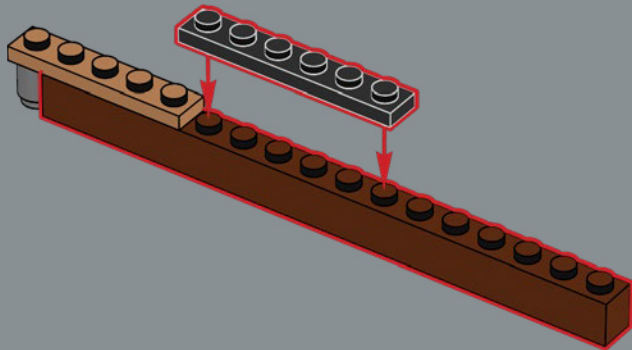

2x

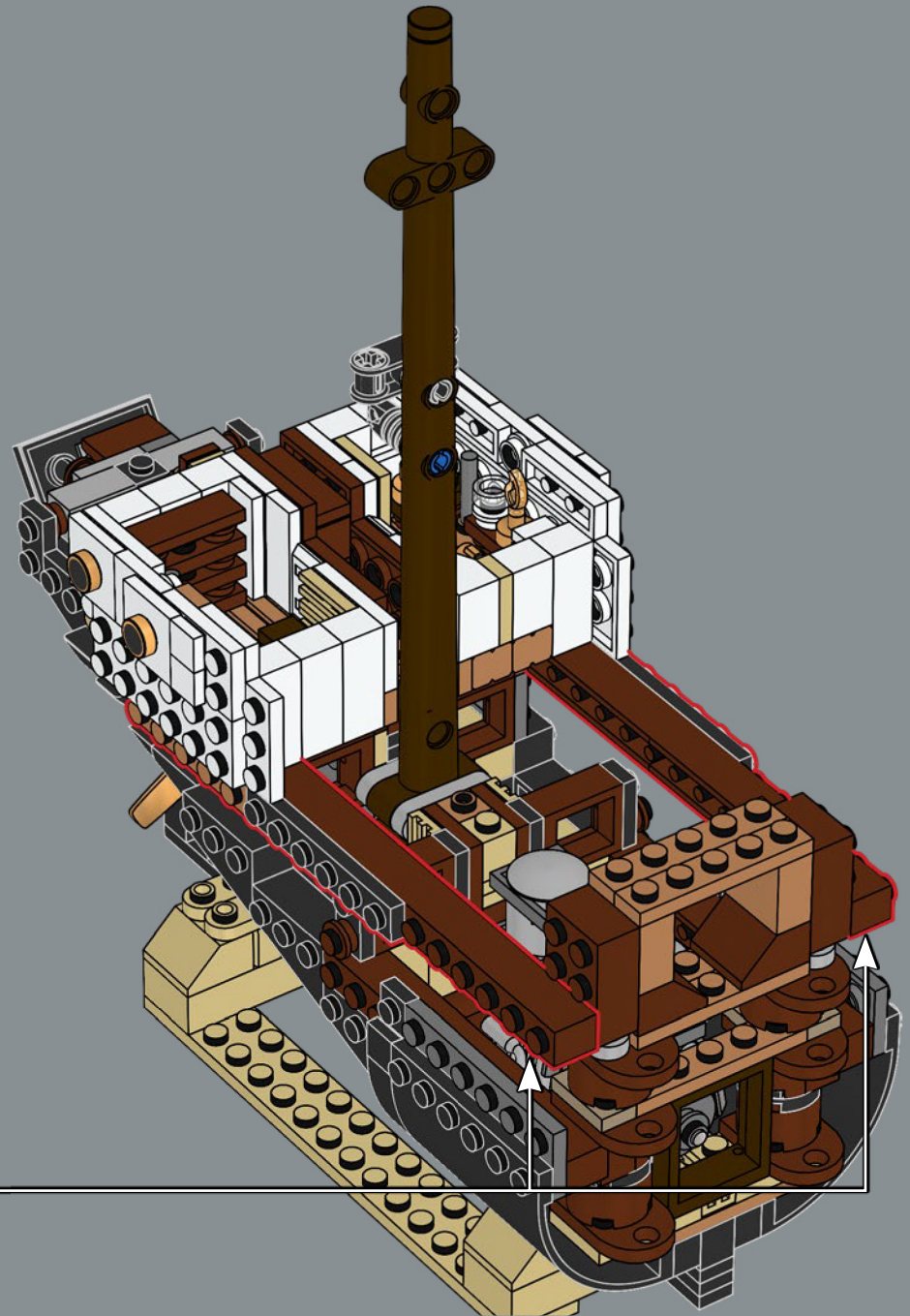

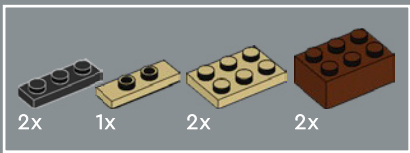

391

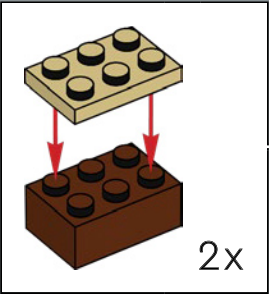
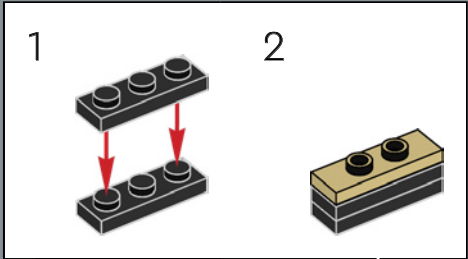
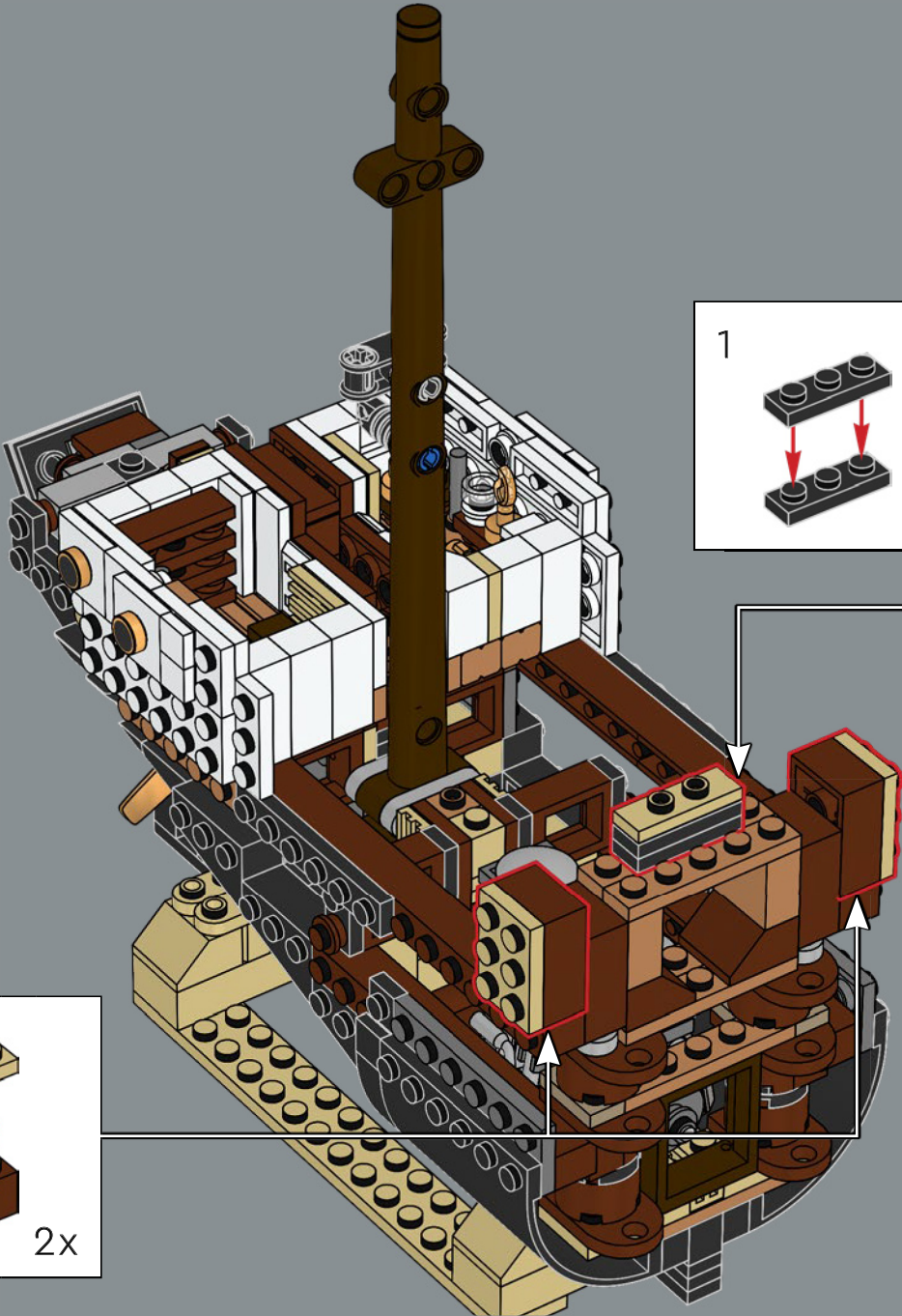

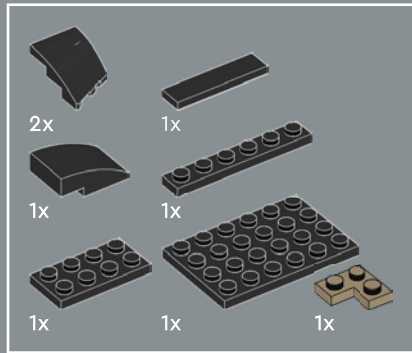

392

1

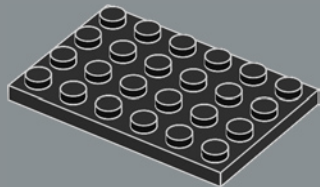

2

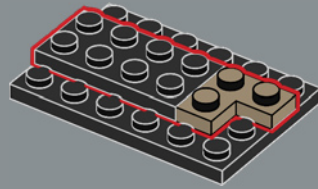

3

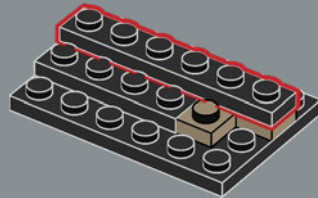

4

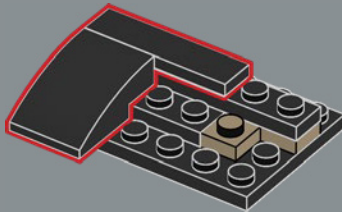

5

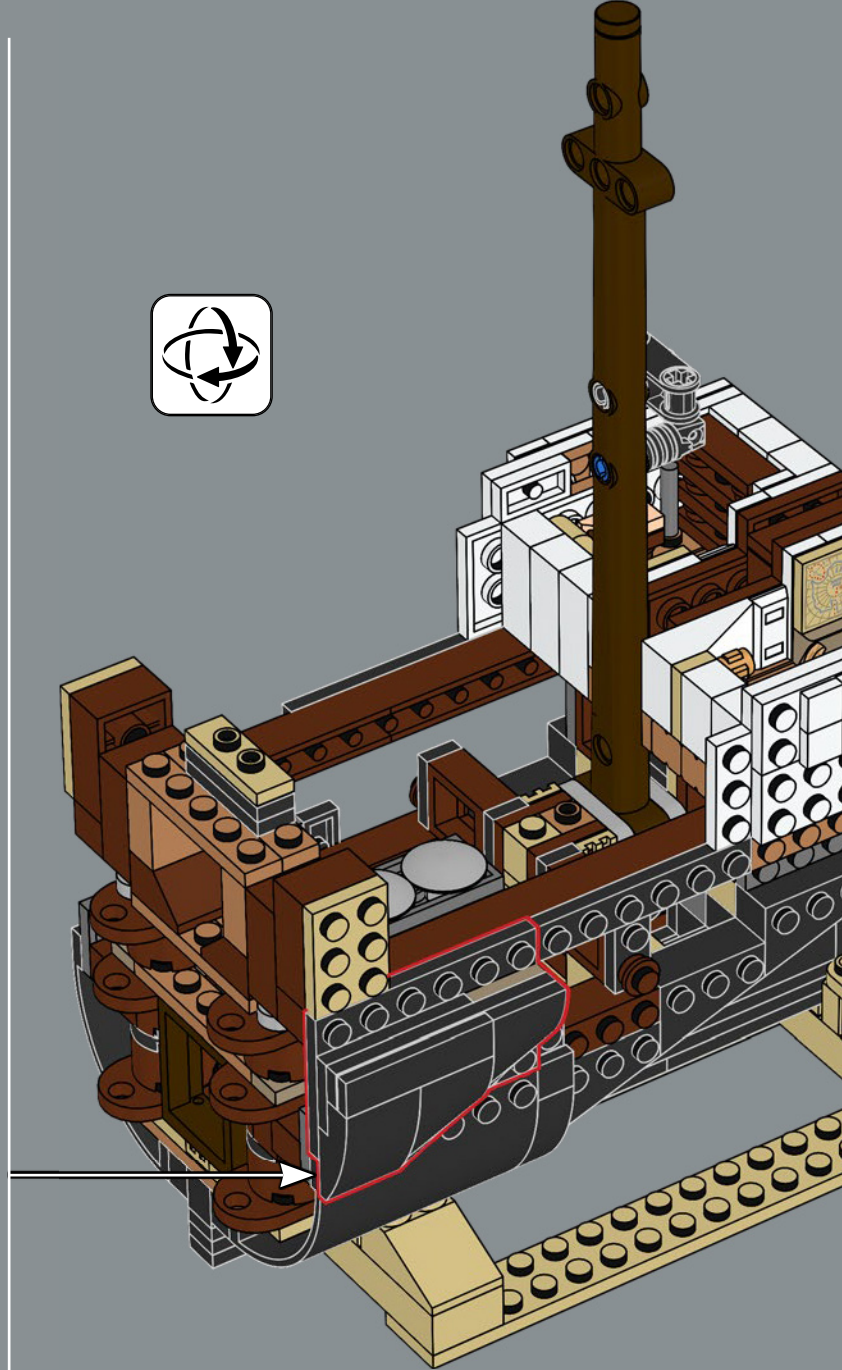
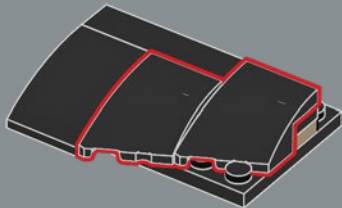

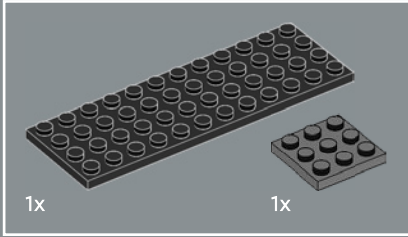
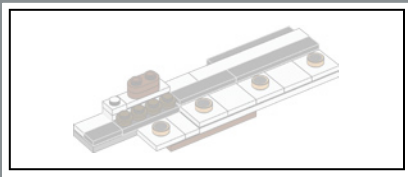

393

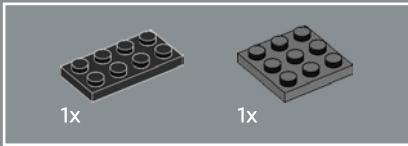
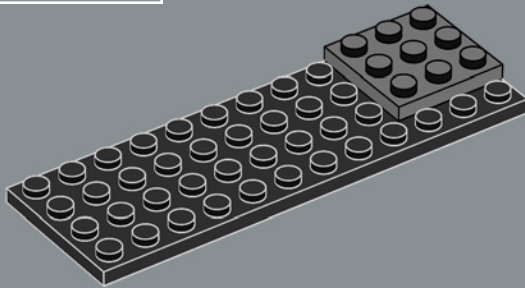

394

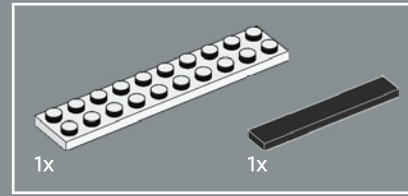
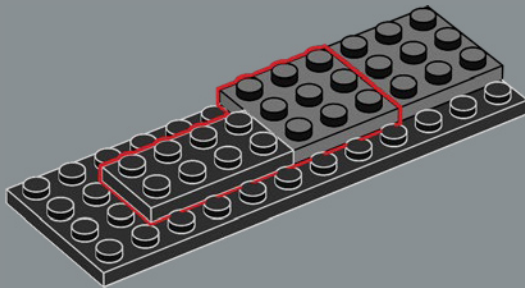

395

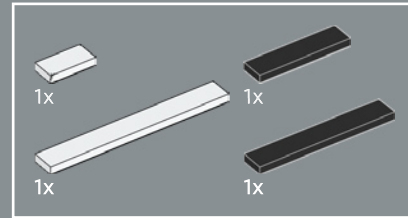
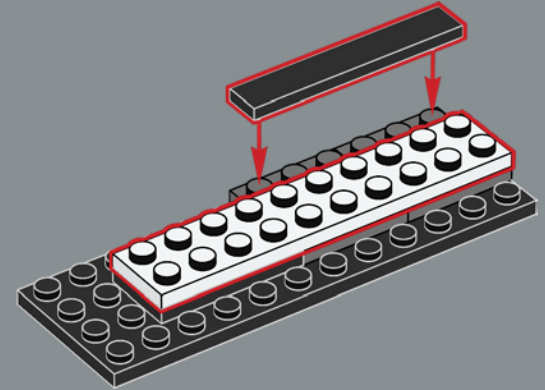

396

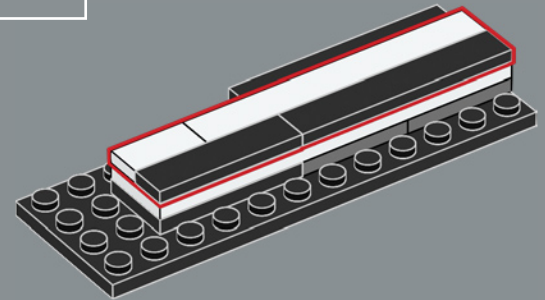

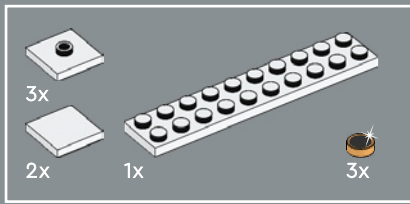

397

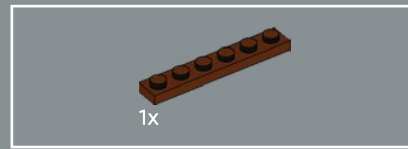
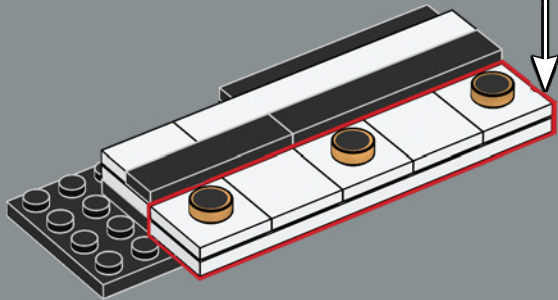
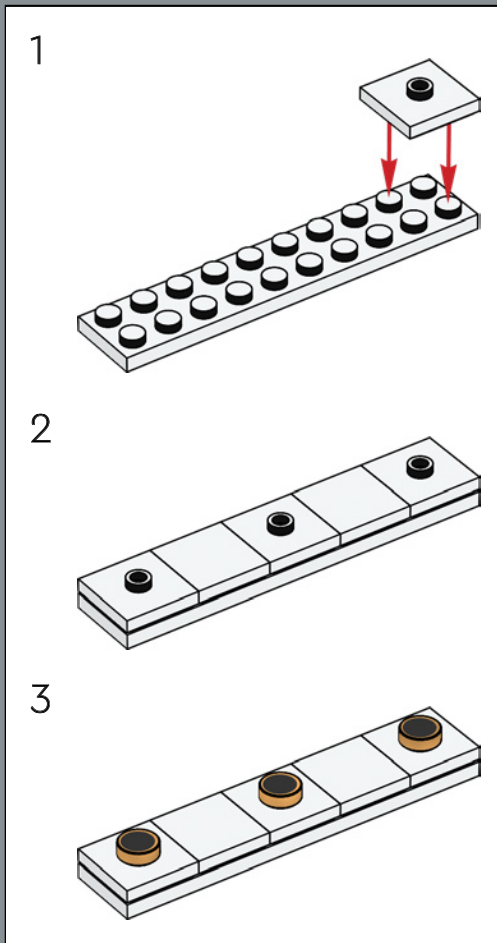

398

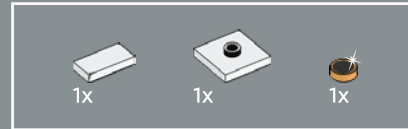
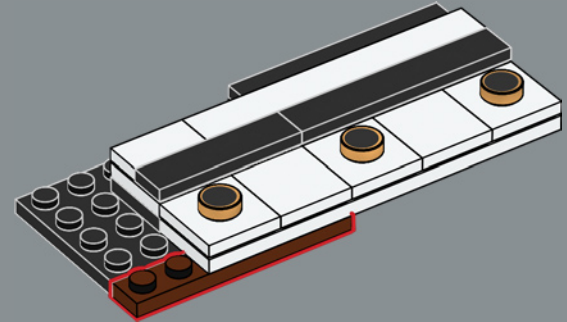

399

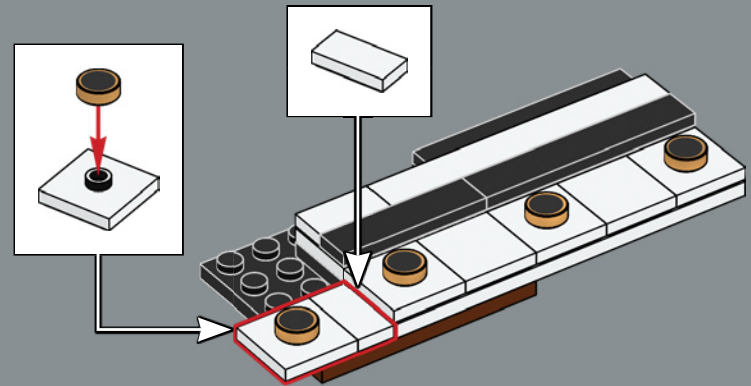

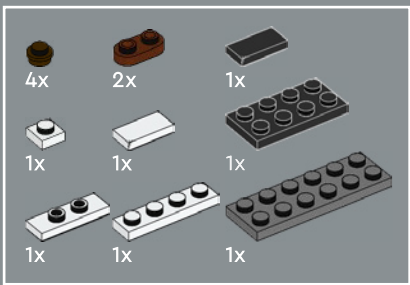

400

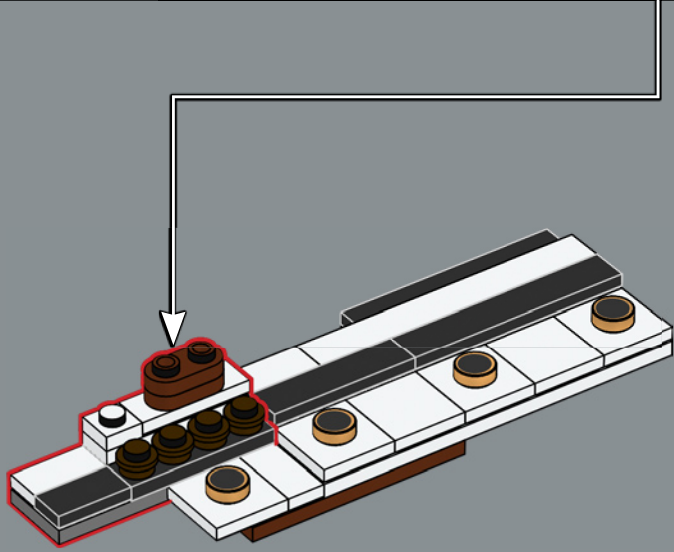
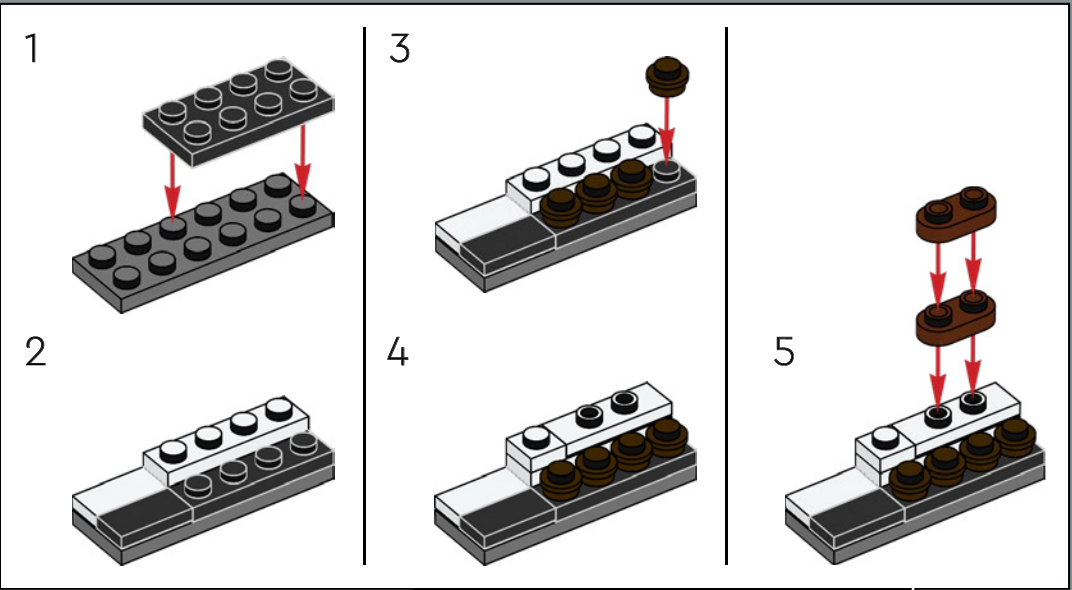

401

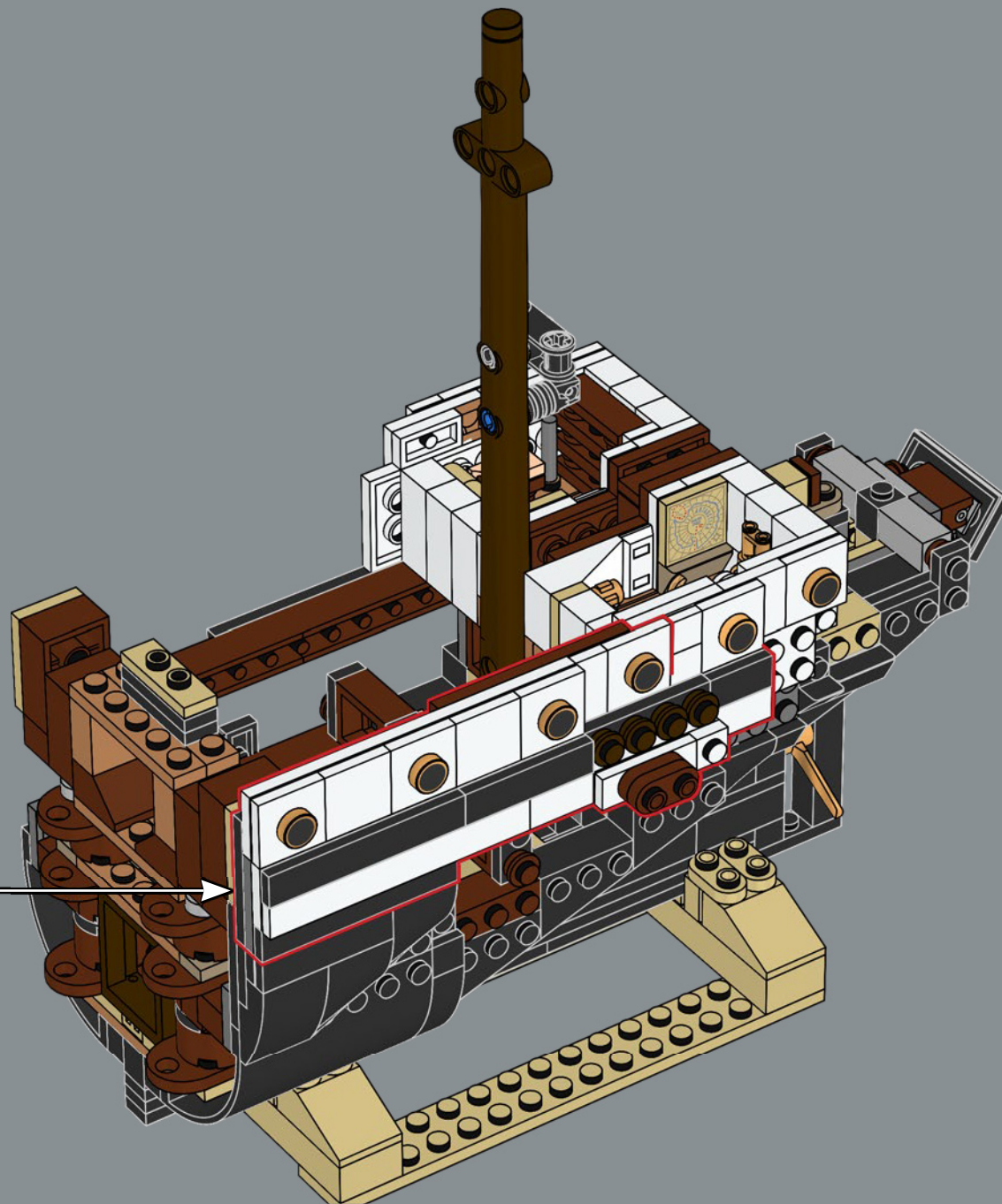

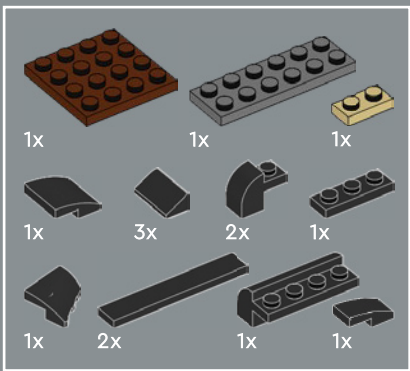

402

1

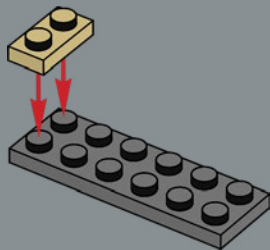

2

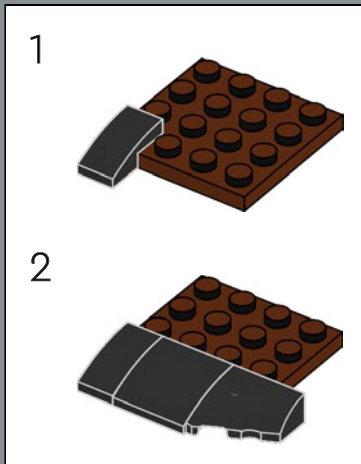
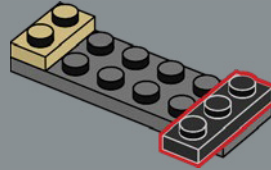

3

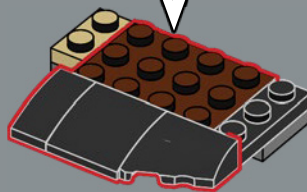

4

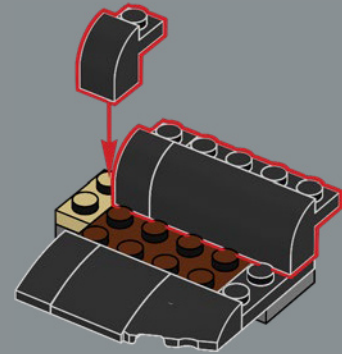

5

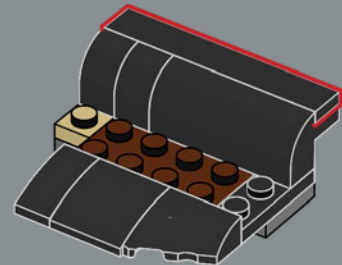

6

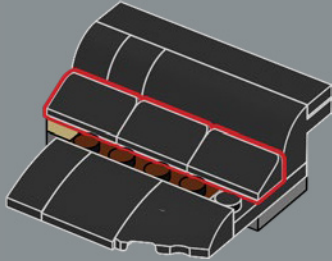

7

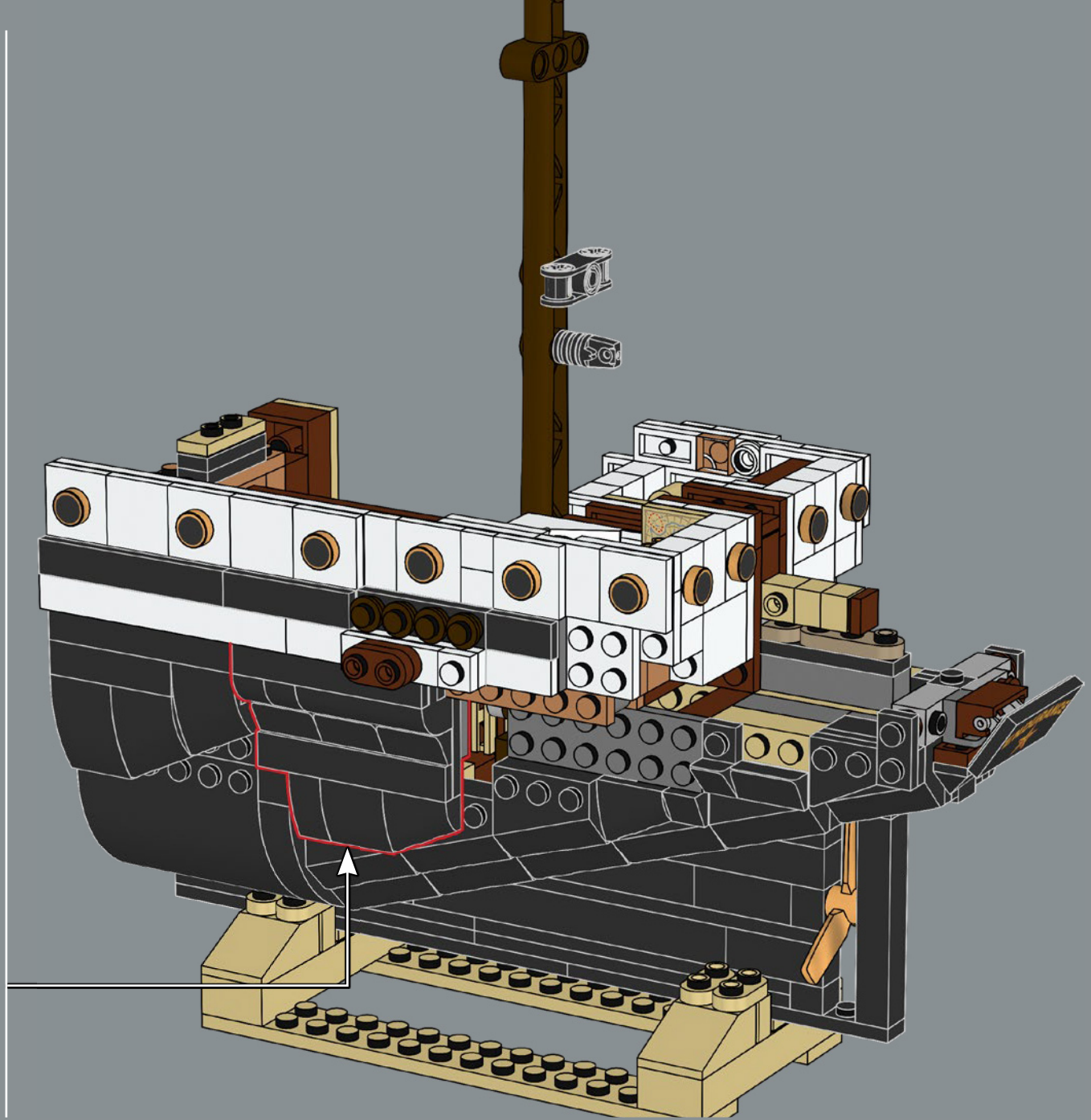
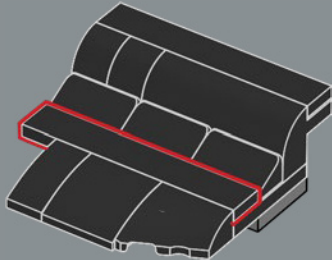

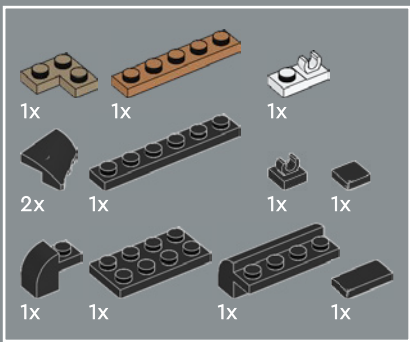

403

1

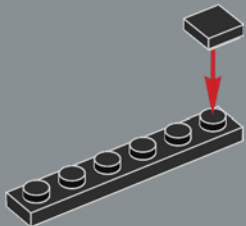

2

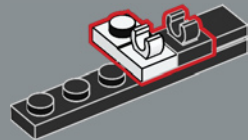

3

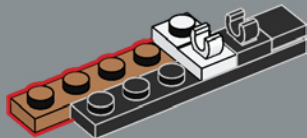

4

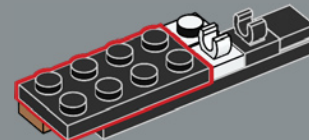

5

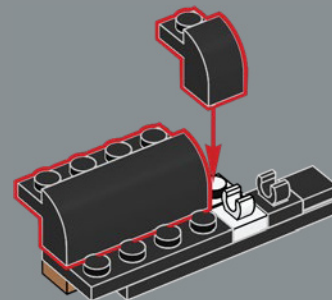

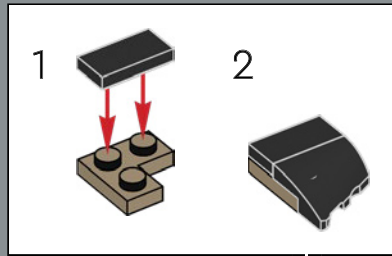

6

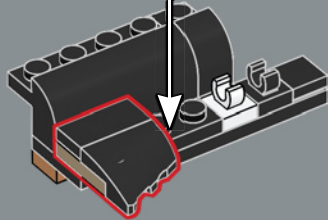

7

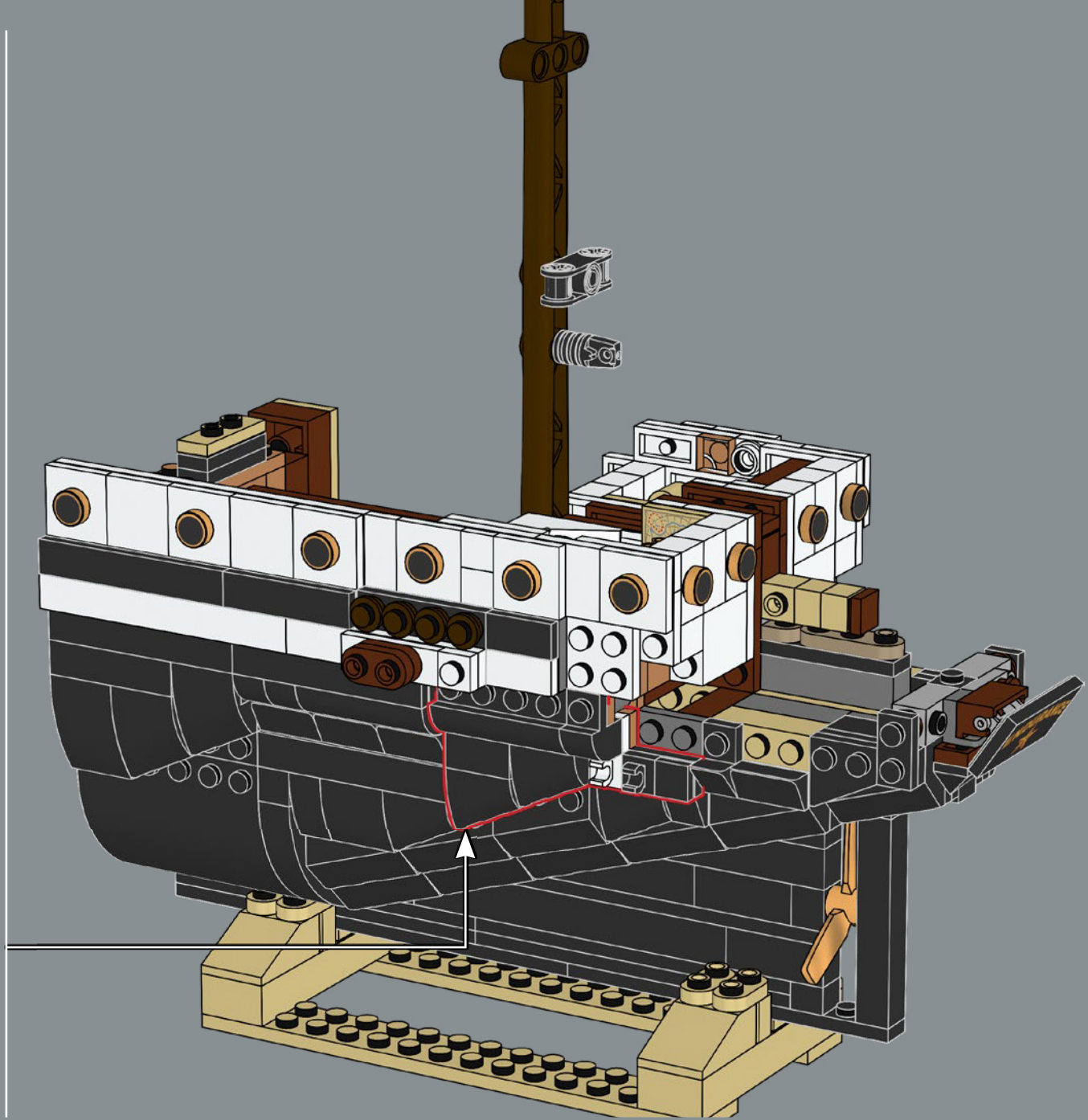
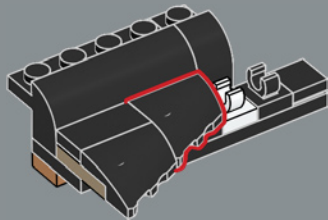

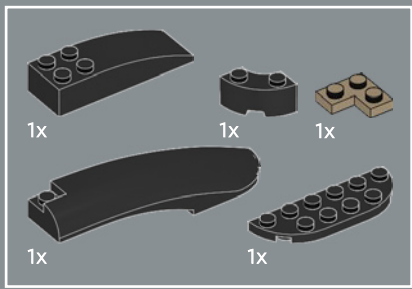

404

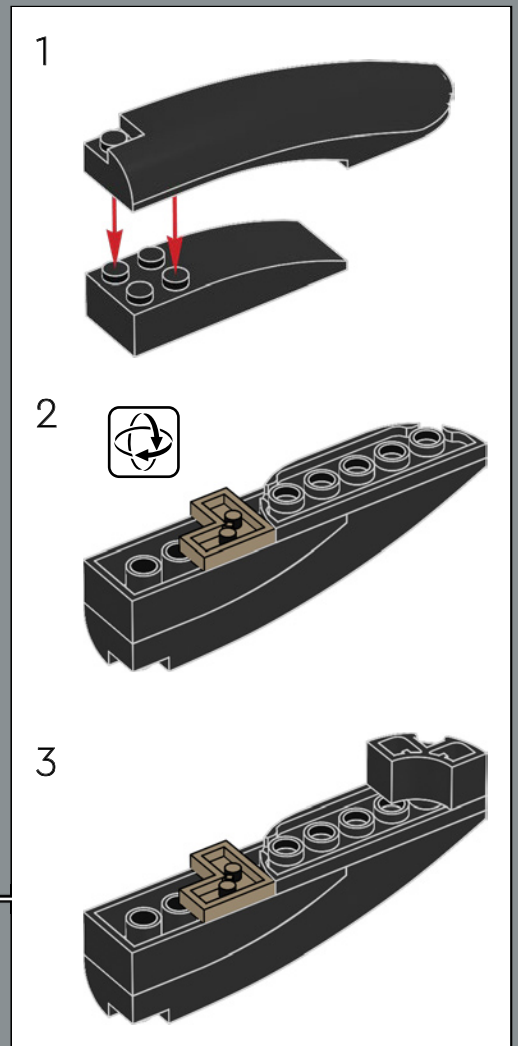
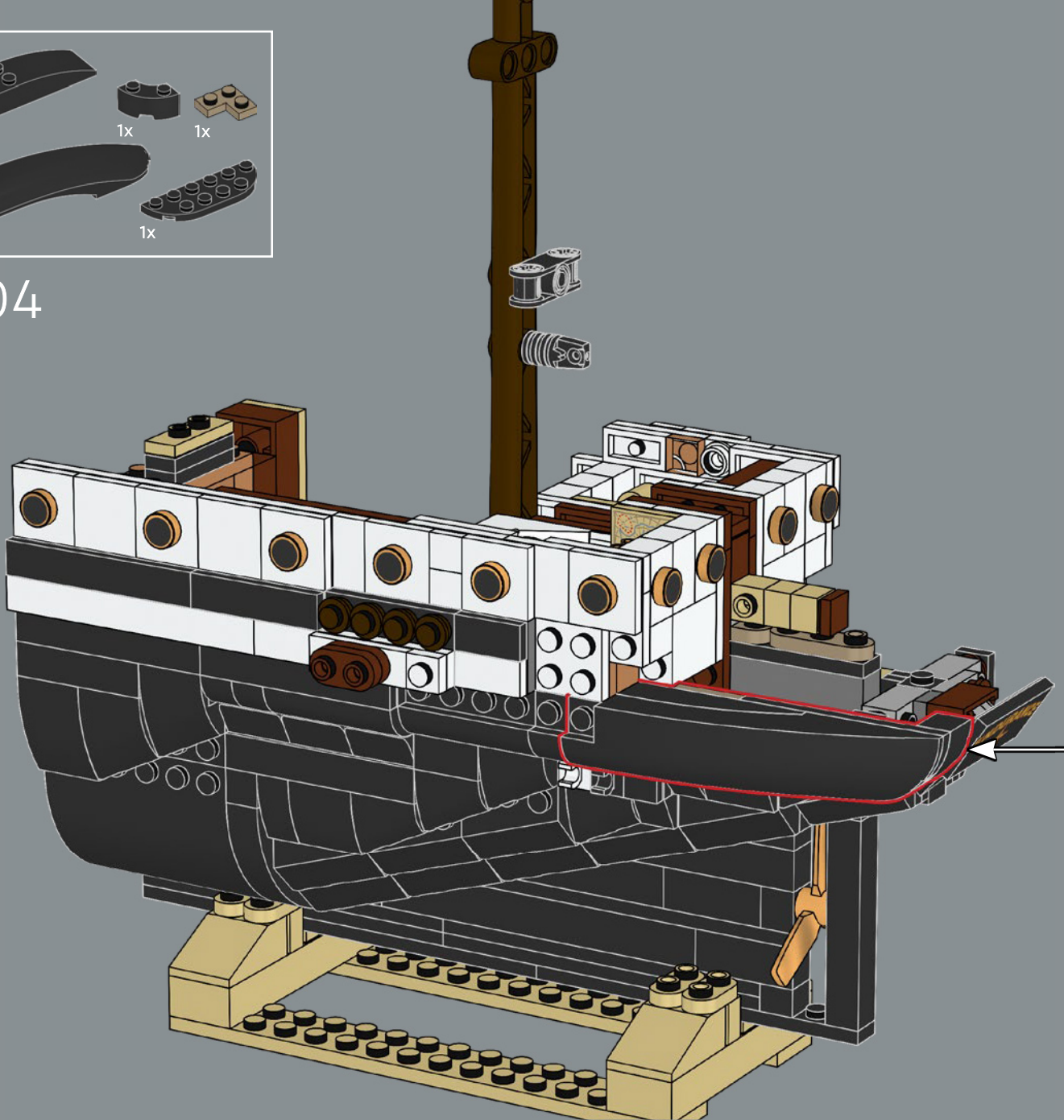

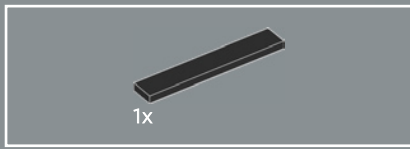

405

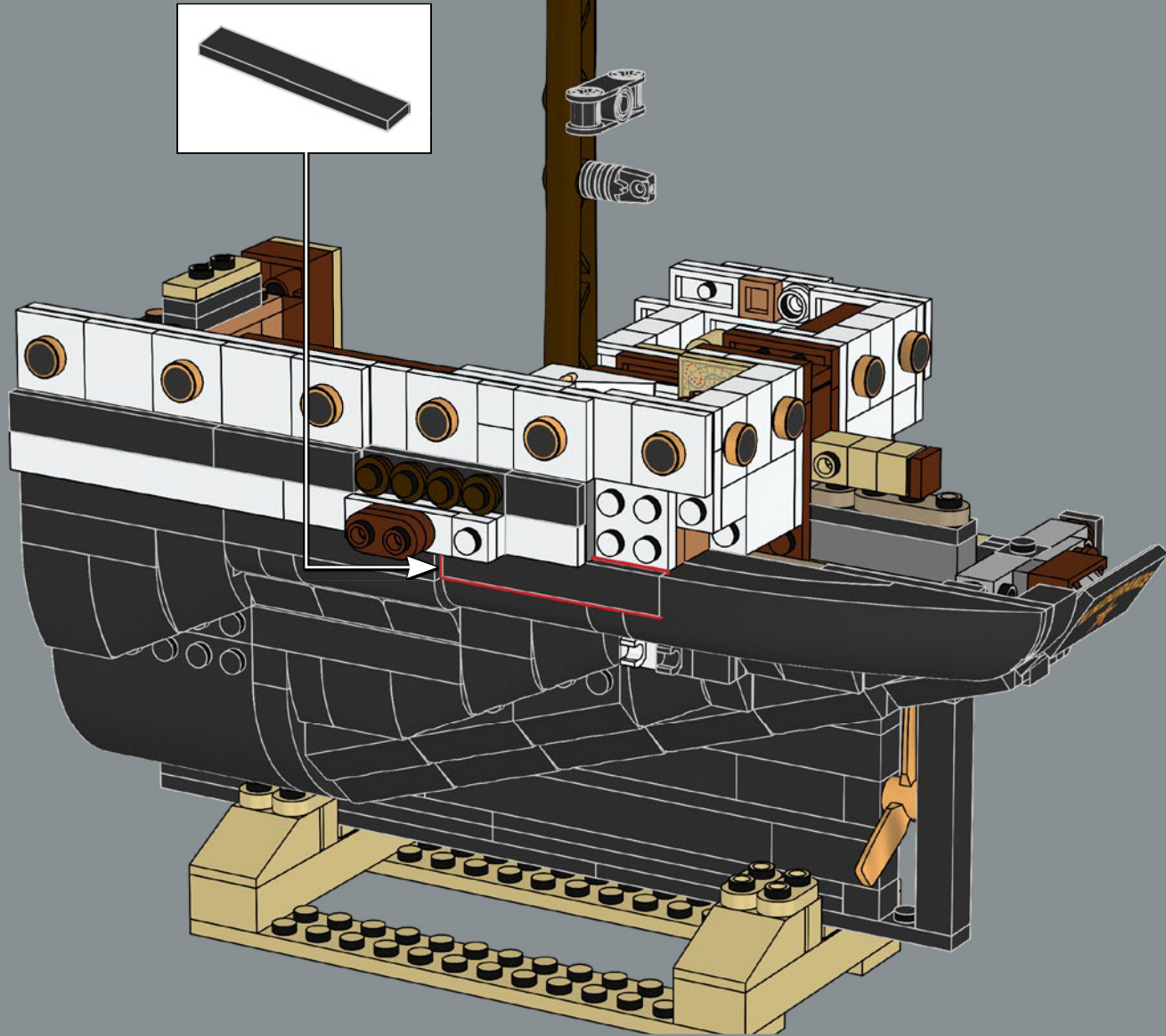

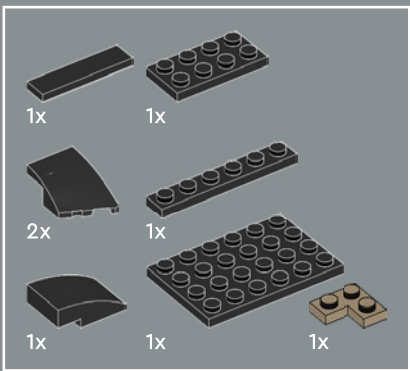
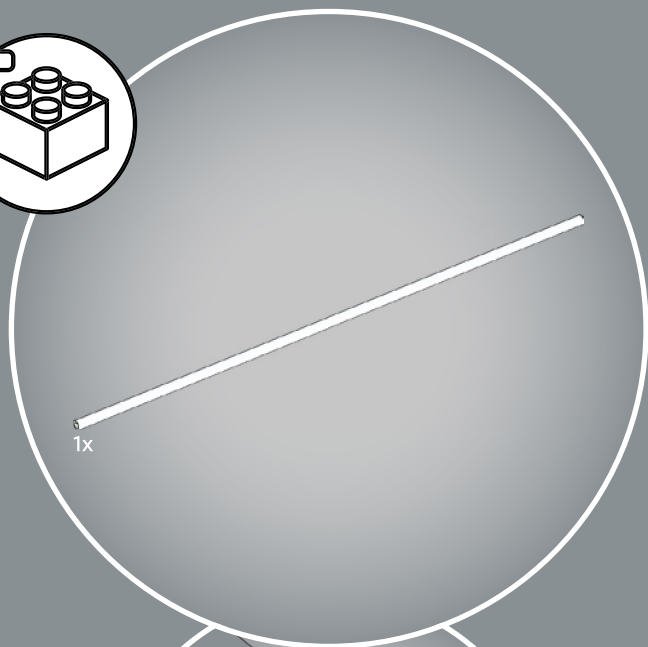
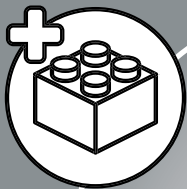

406



1

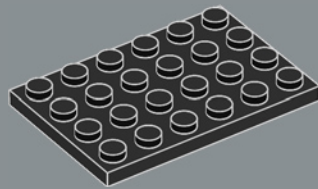

2

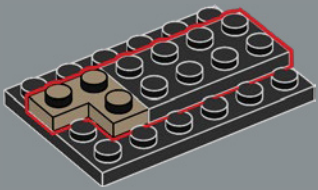

3

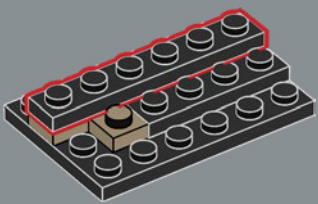

4

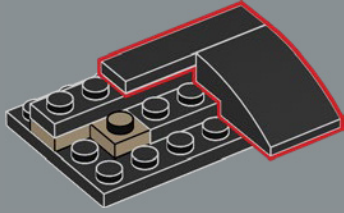

5

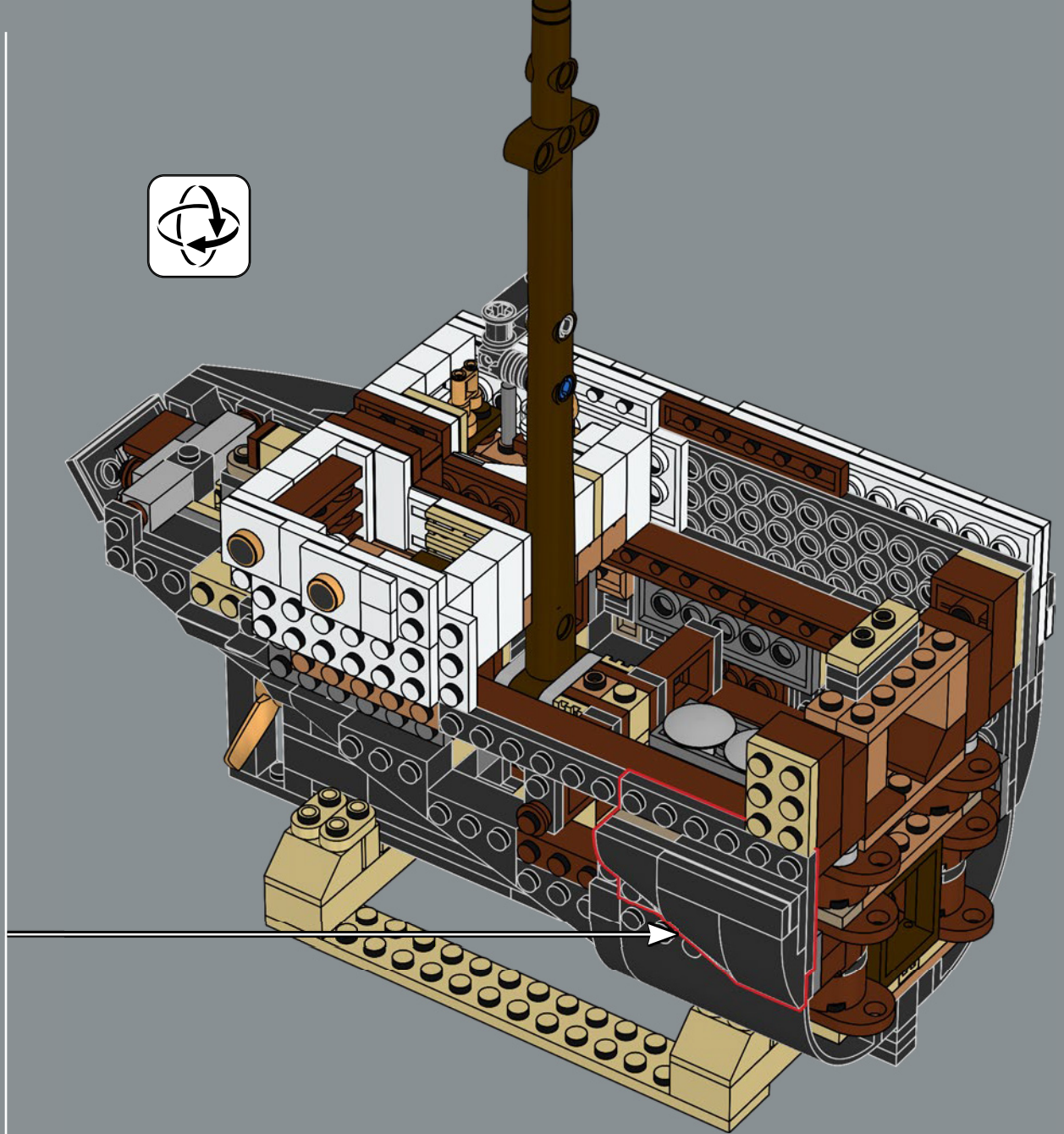
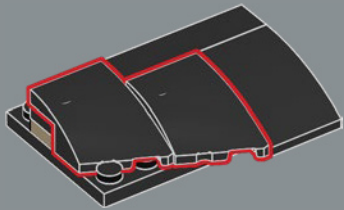

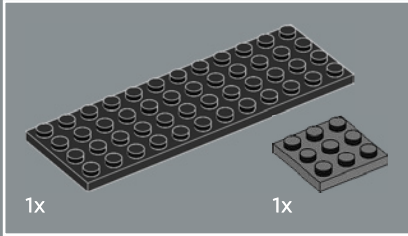
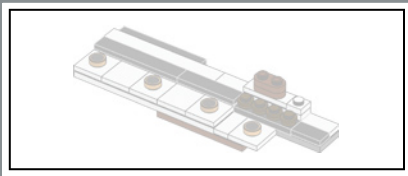

407

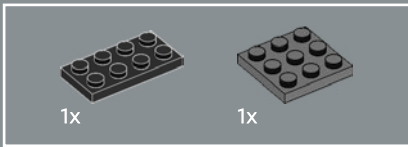
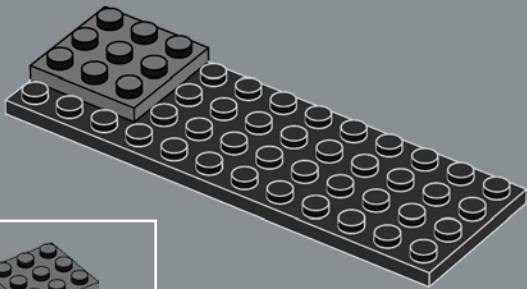

408

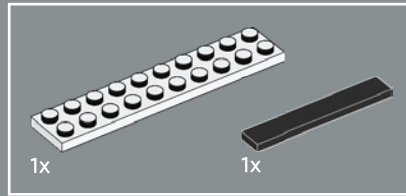
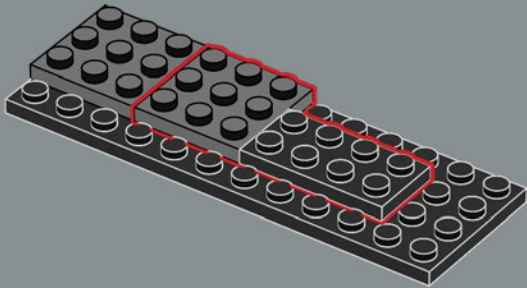

409

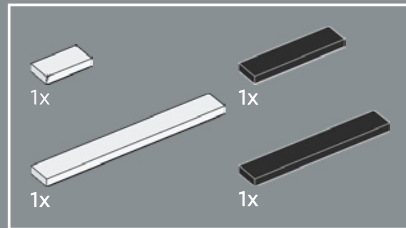
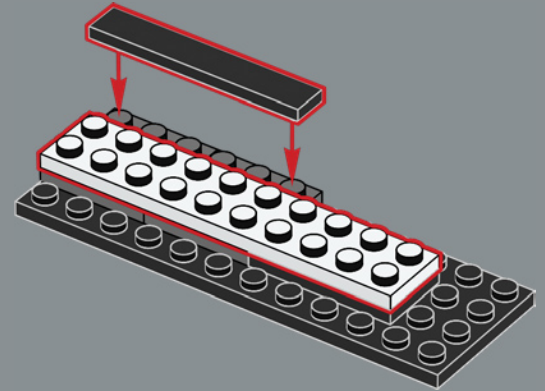

410

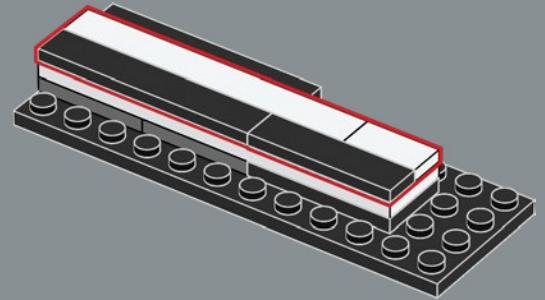

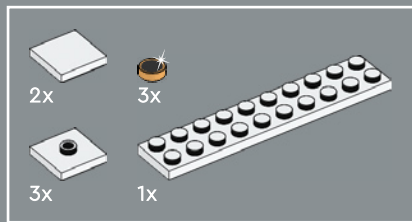

411

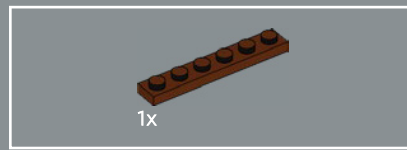
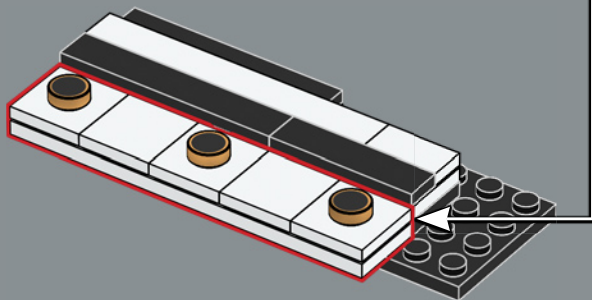
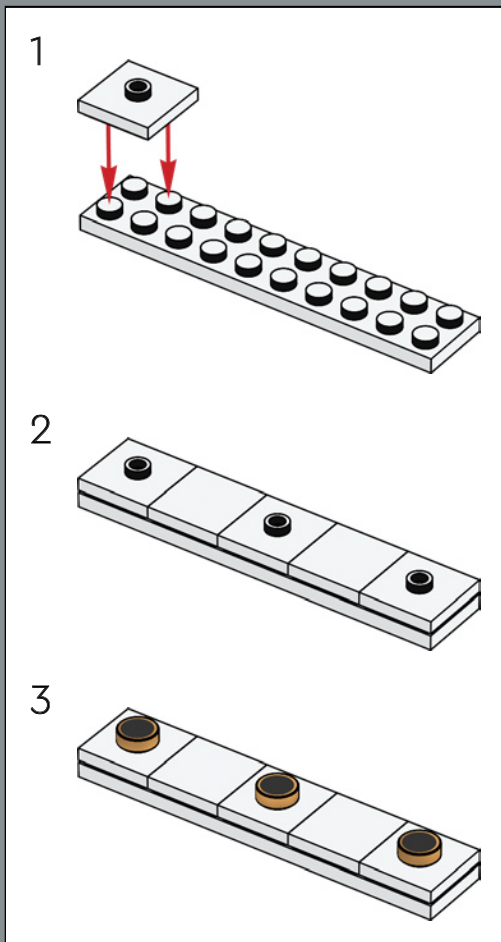

412

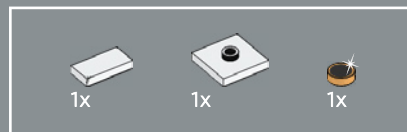
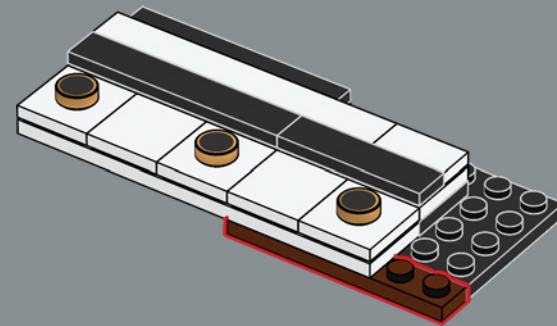

413

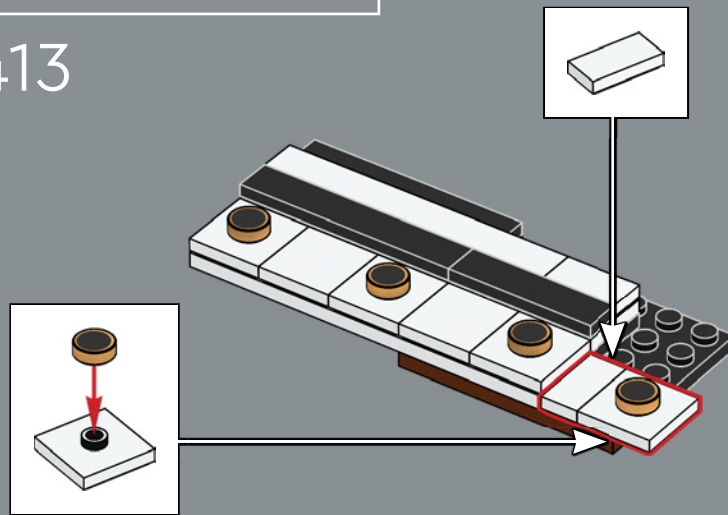

415

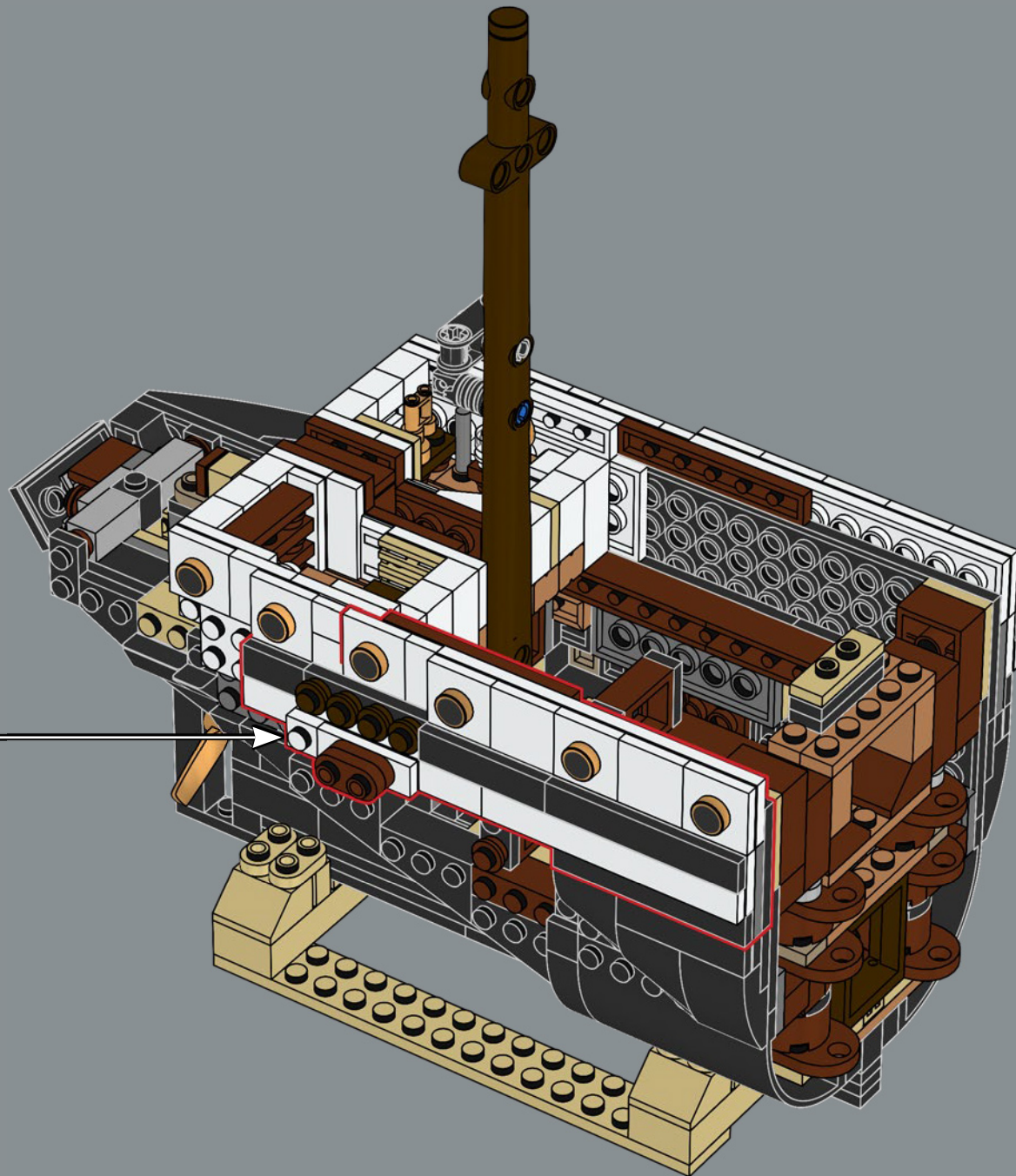

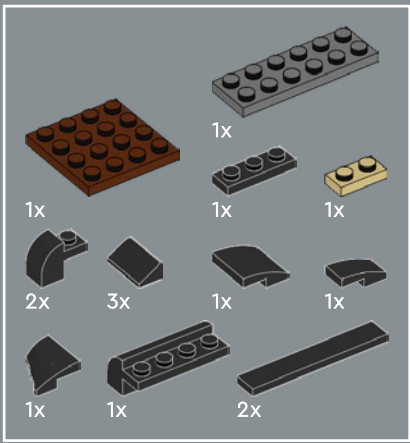

416

1

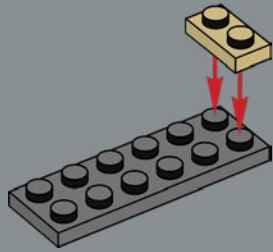

2

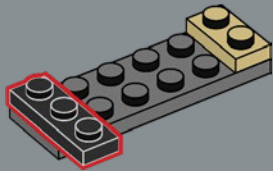

1

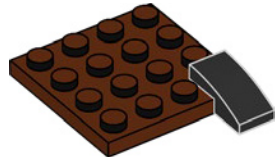

2

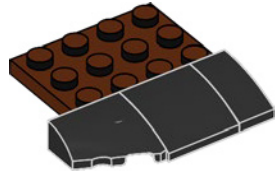

3

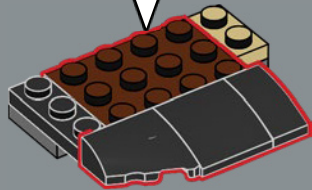

4

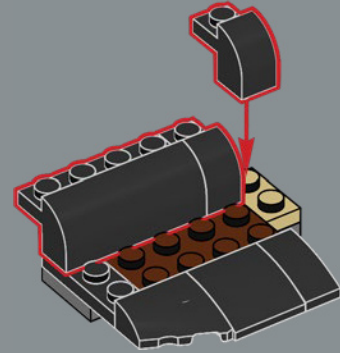

5

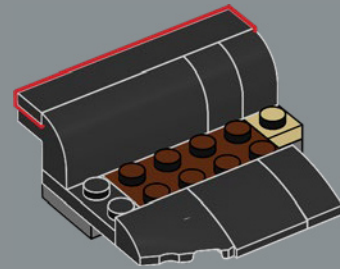

6

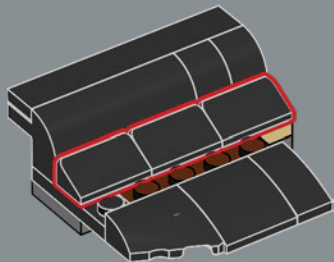

7

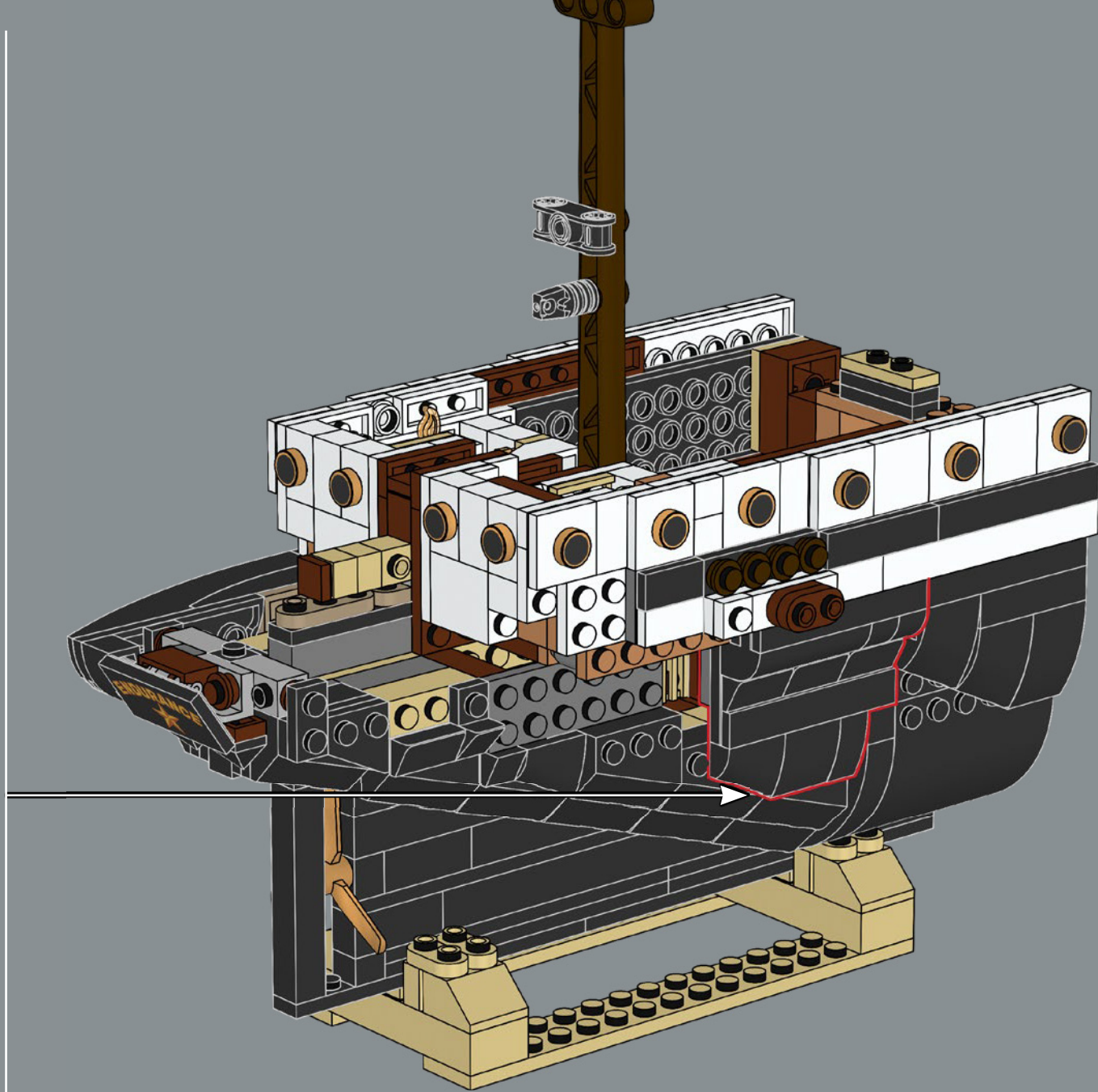
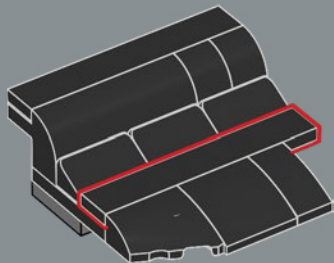

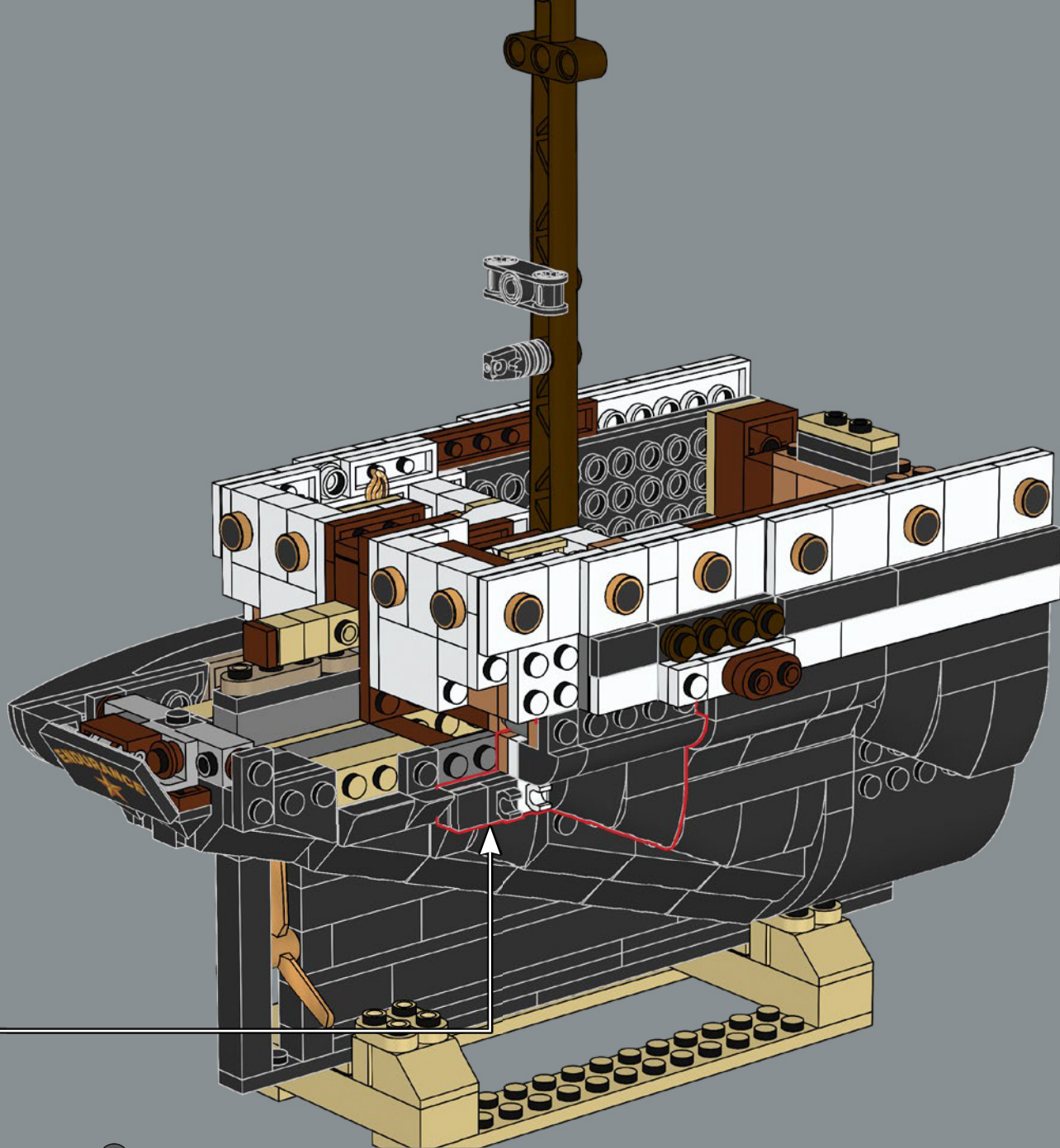

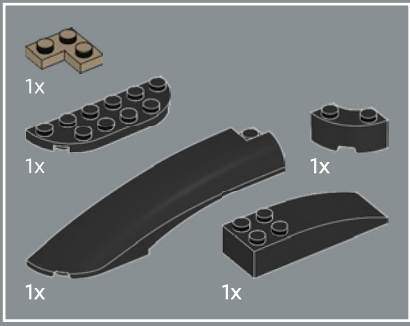

418

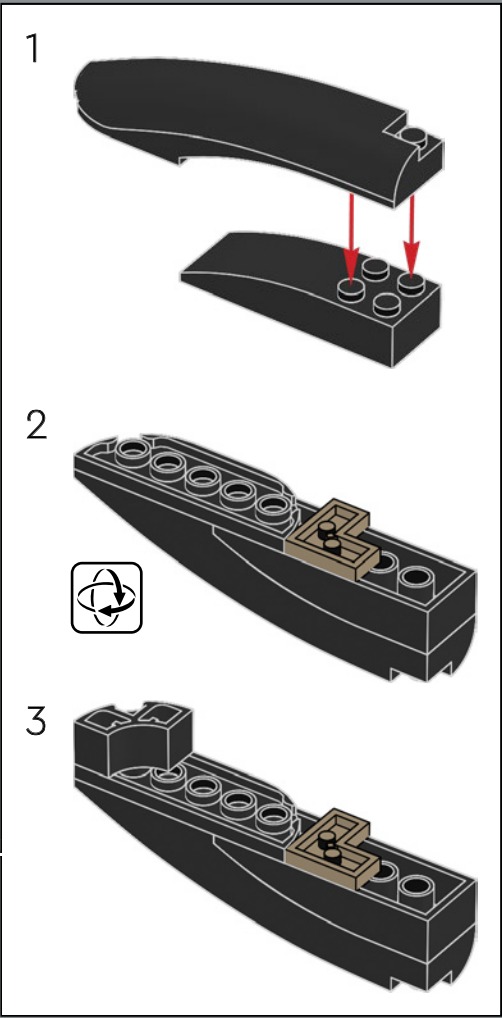
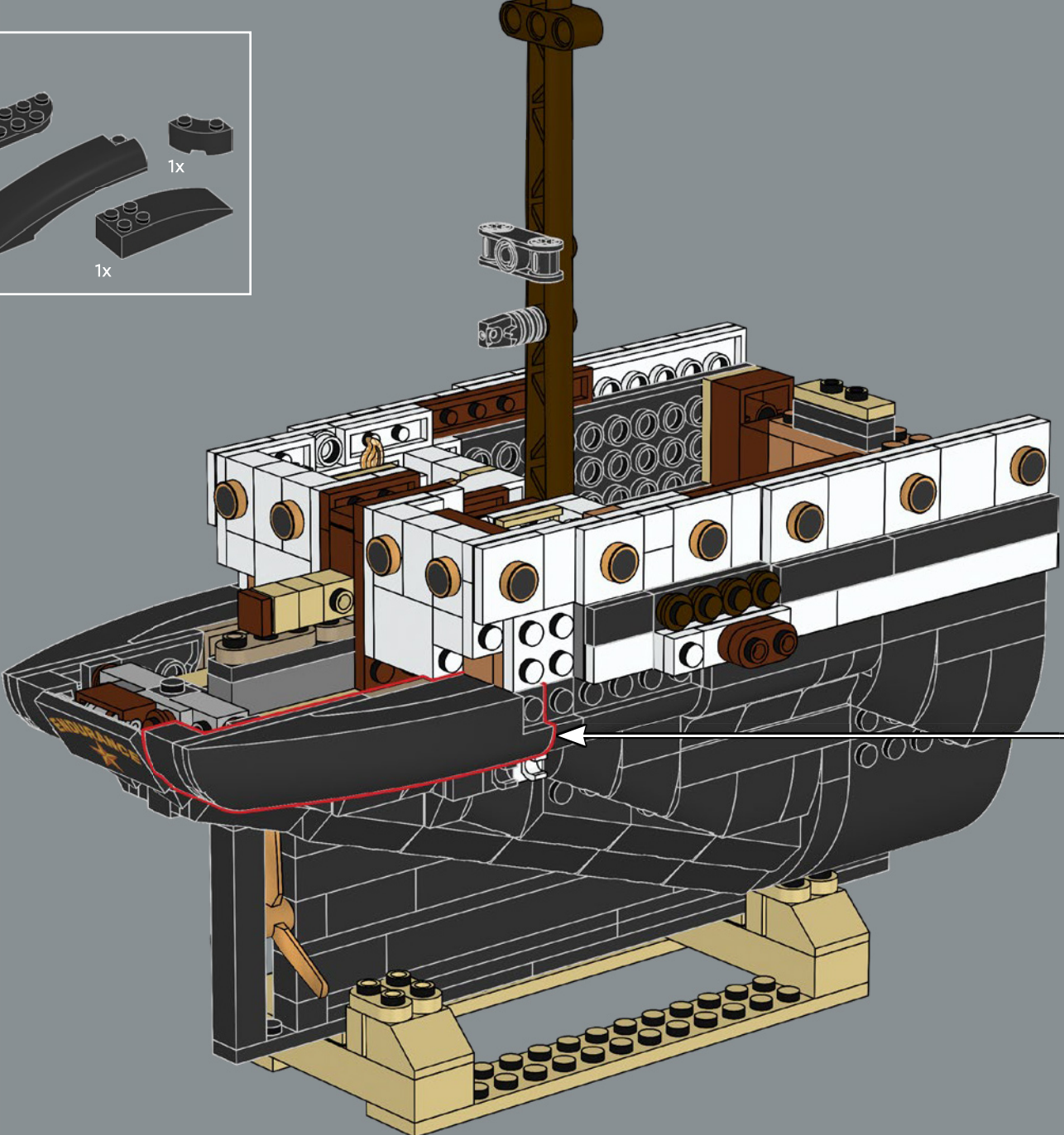

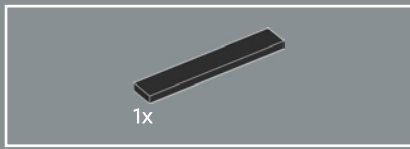

419

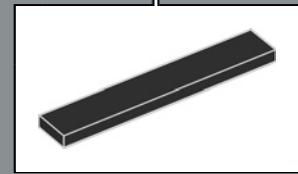
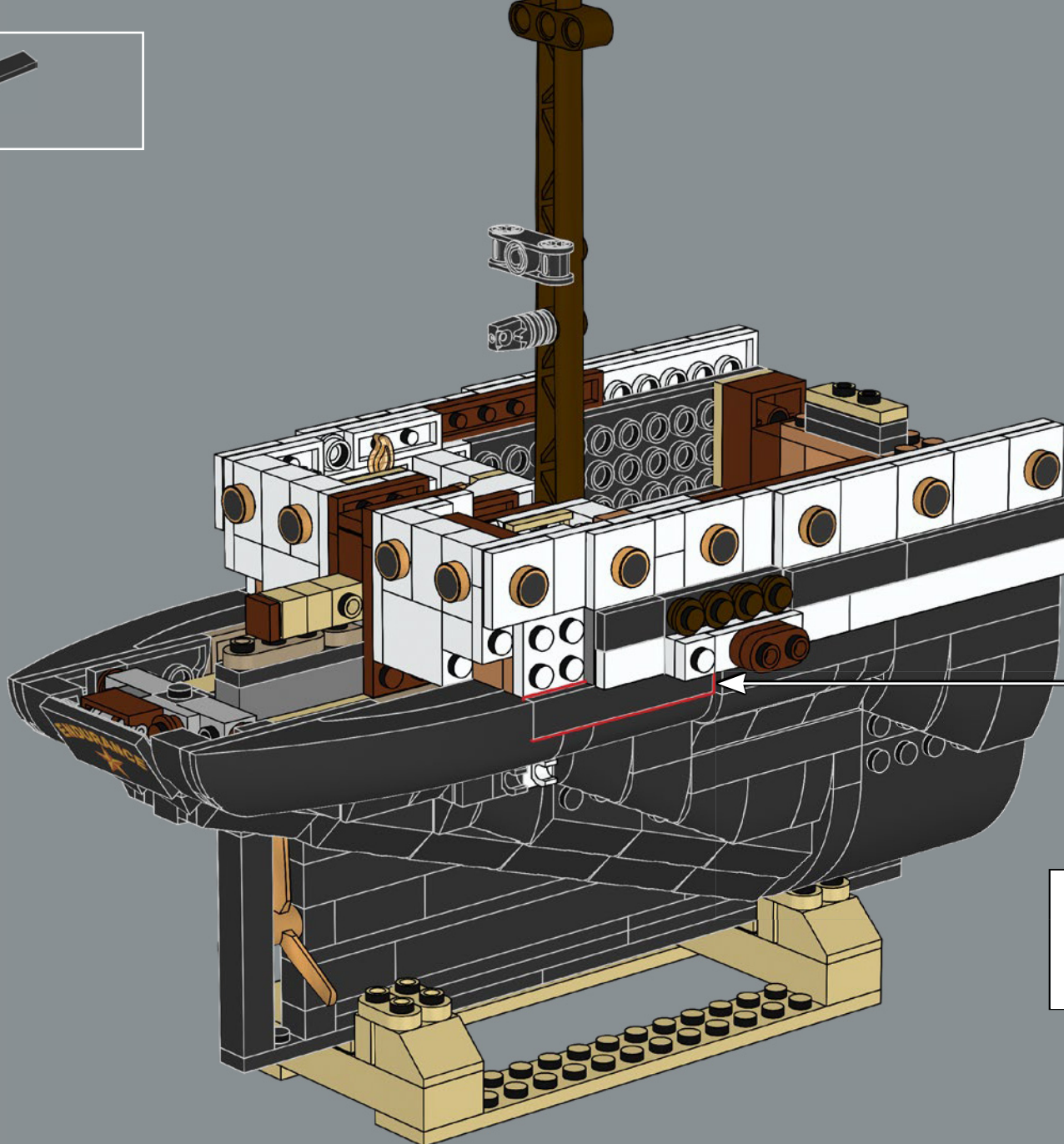

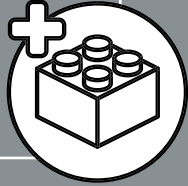
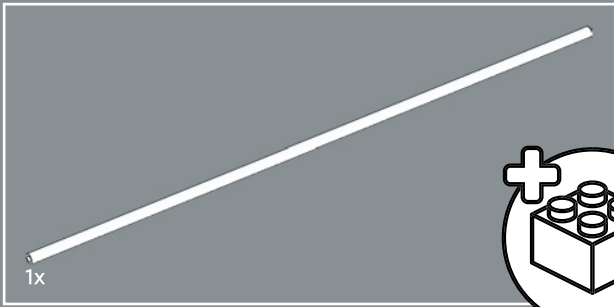

420

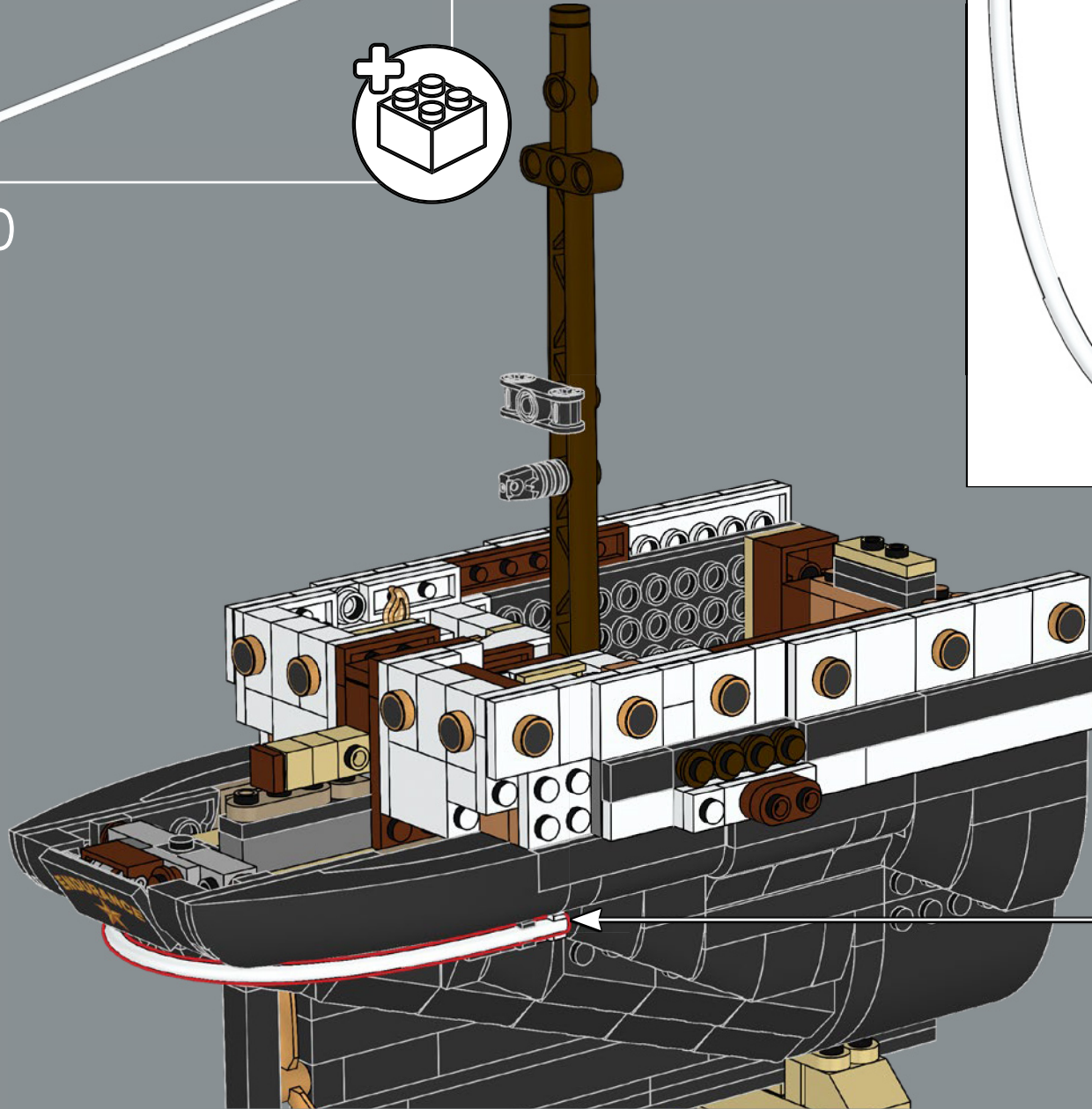
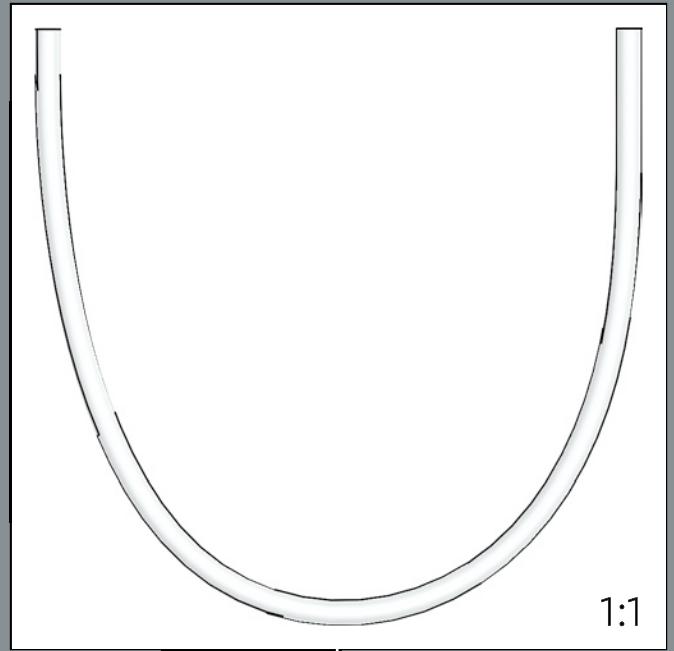

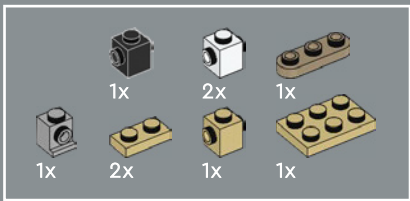
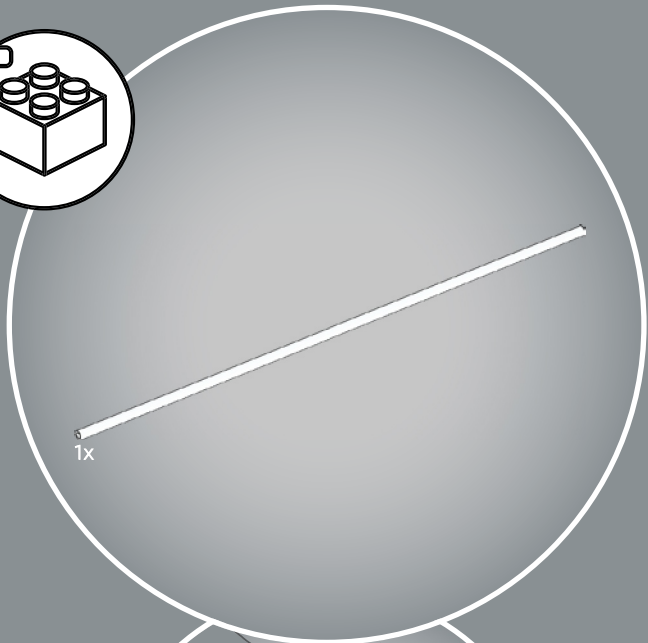
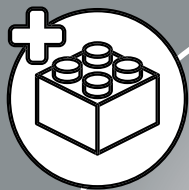

421

1

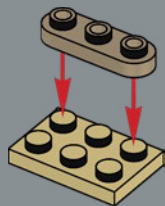

2

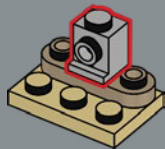

3

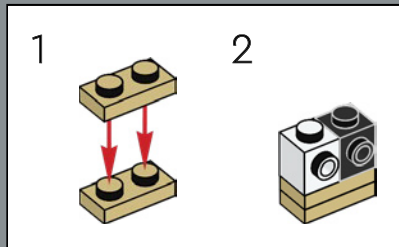
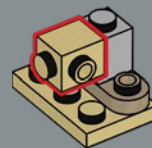

4

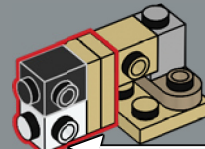

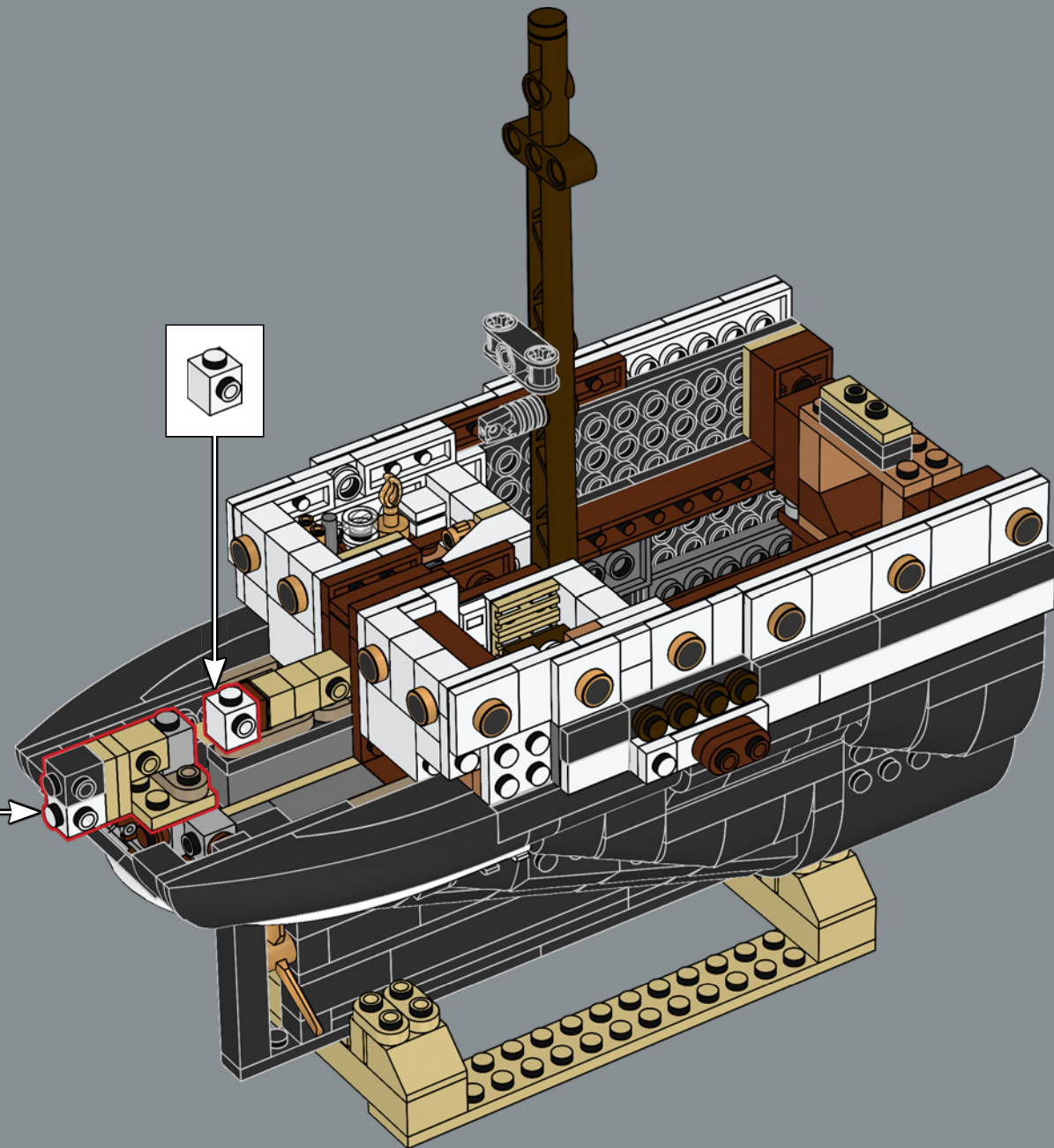

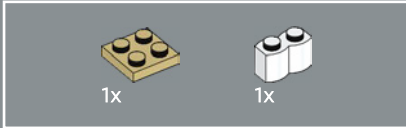
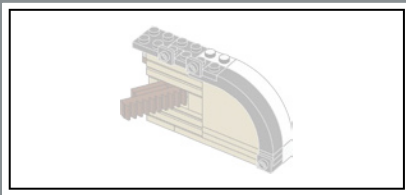

422

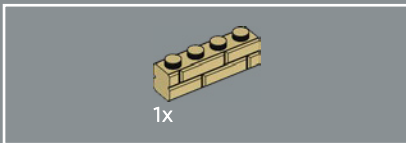
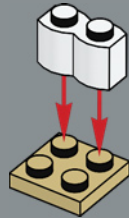

423

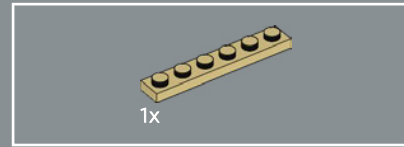
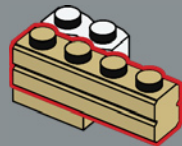

424

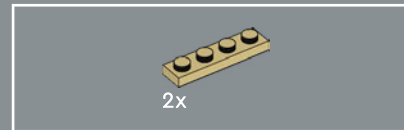
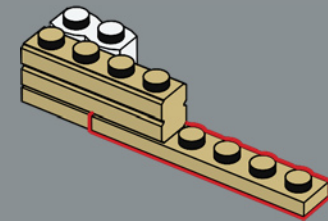

425

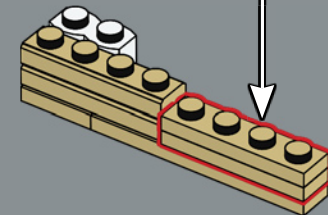
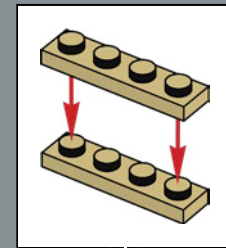

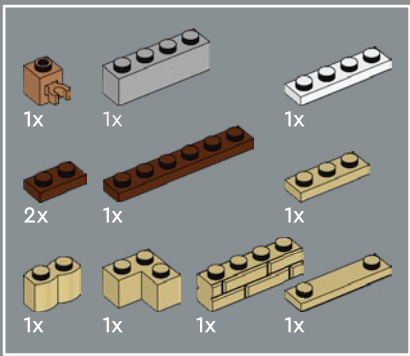

426 1

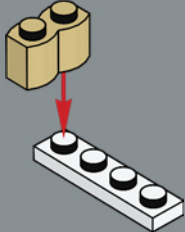

2

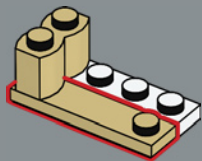

3

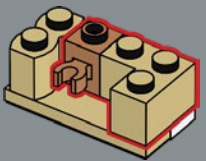

4

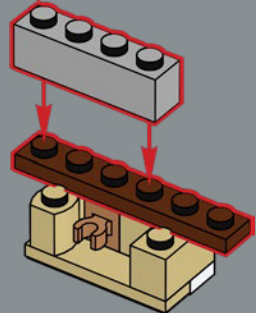

5

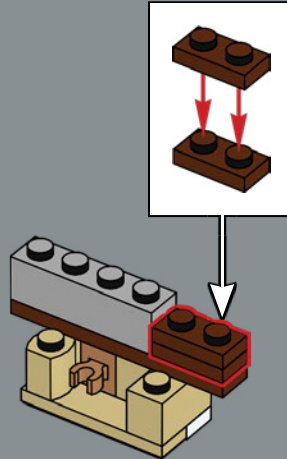

6

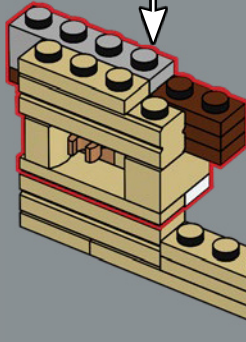
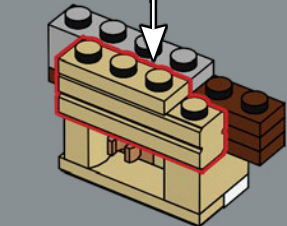
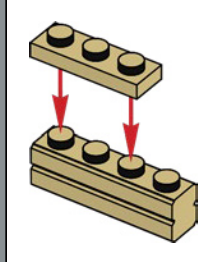

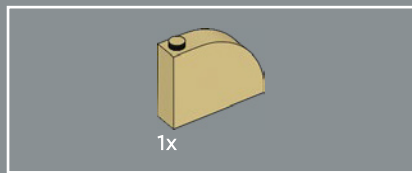

427

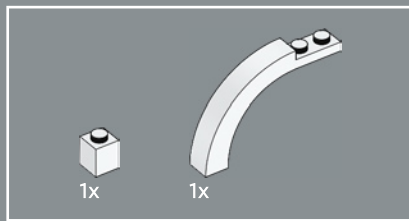
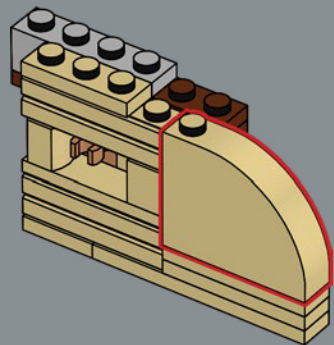

428

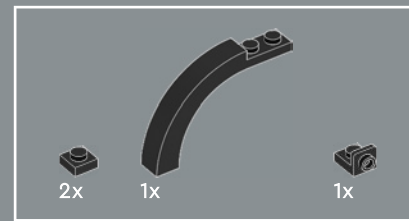
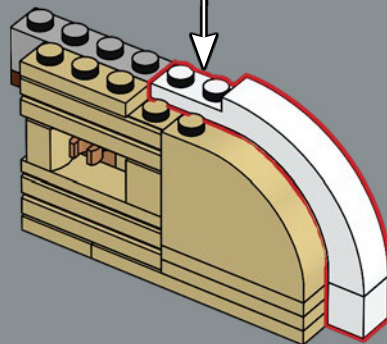
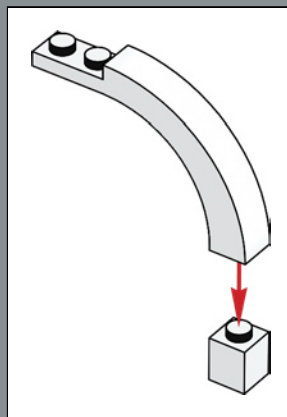

429

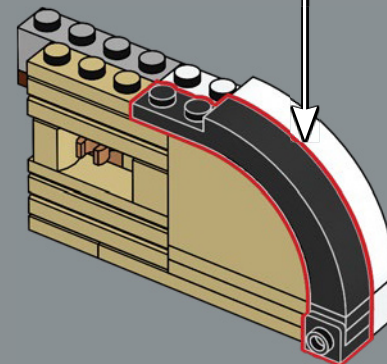
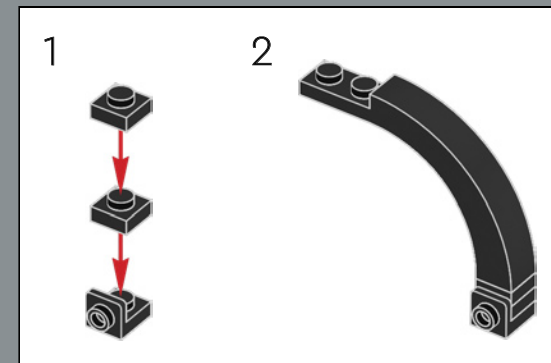

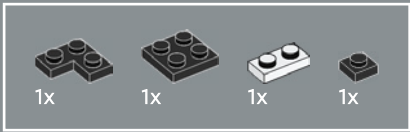

430

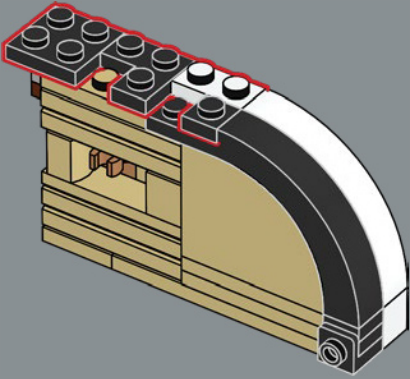

431

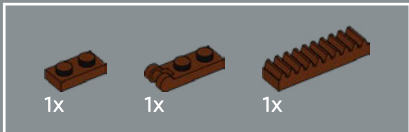
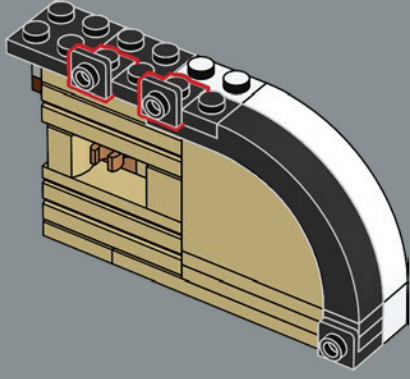

432

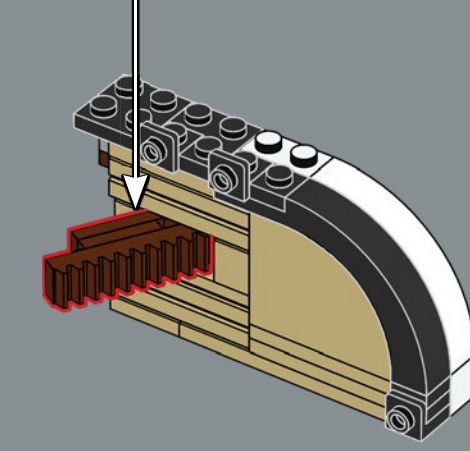
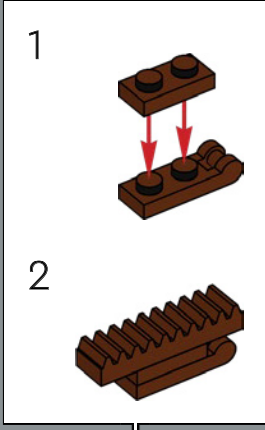

433

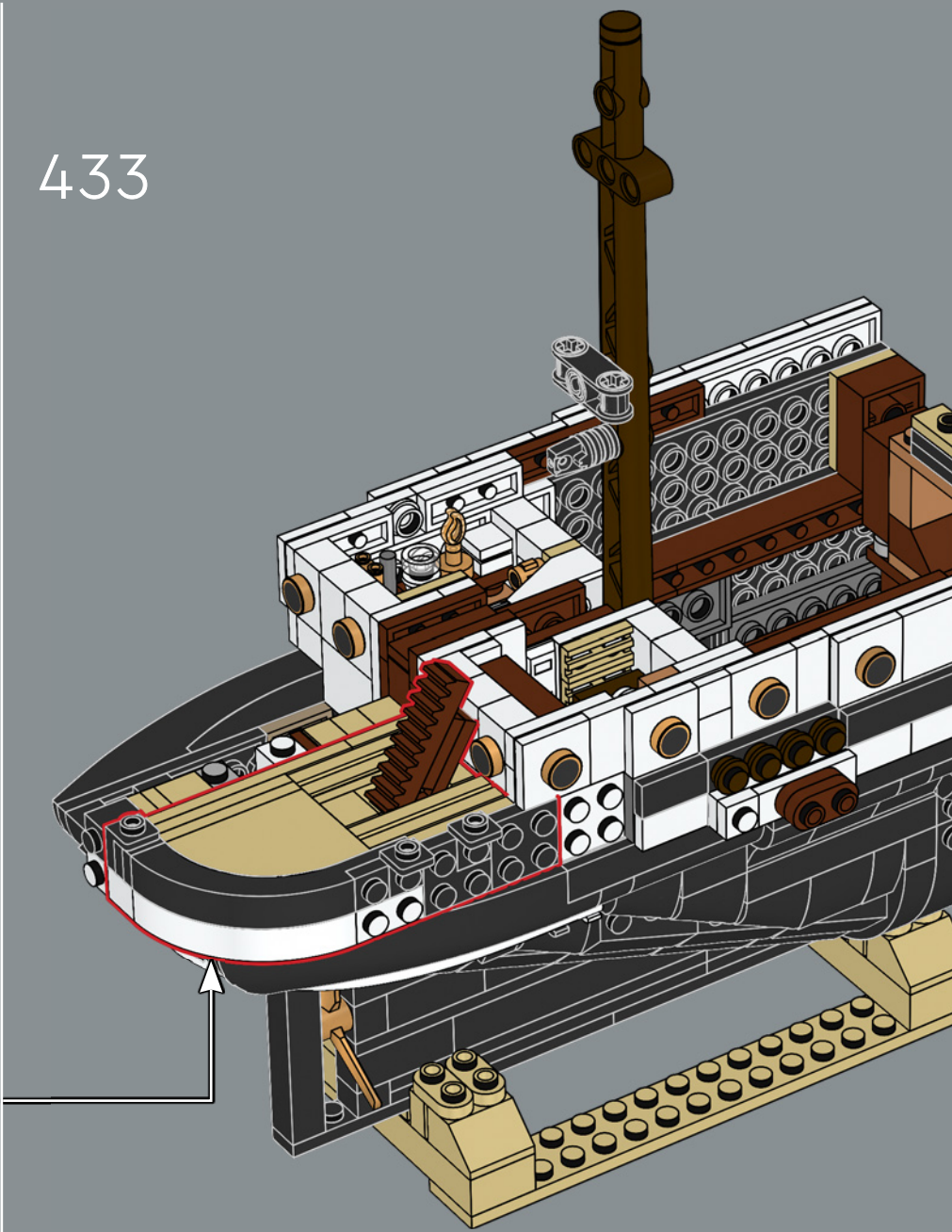

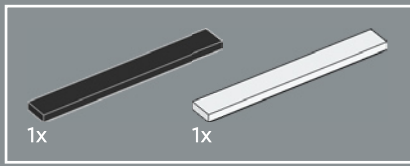

434

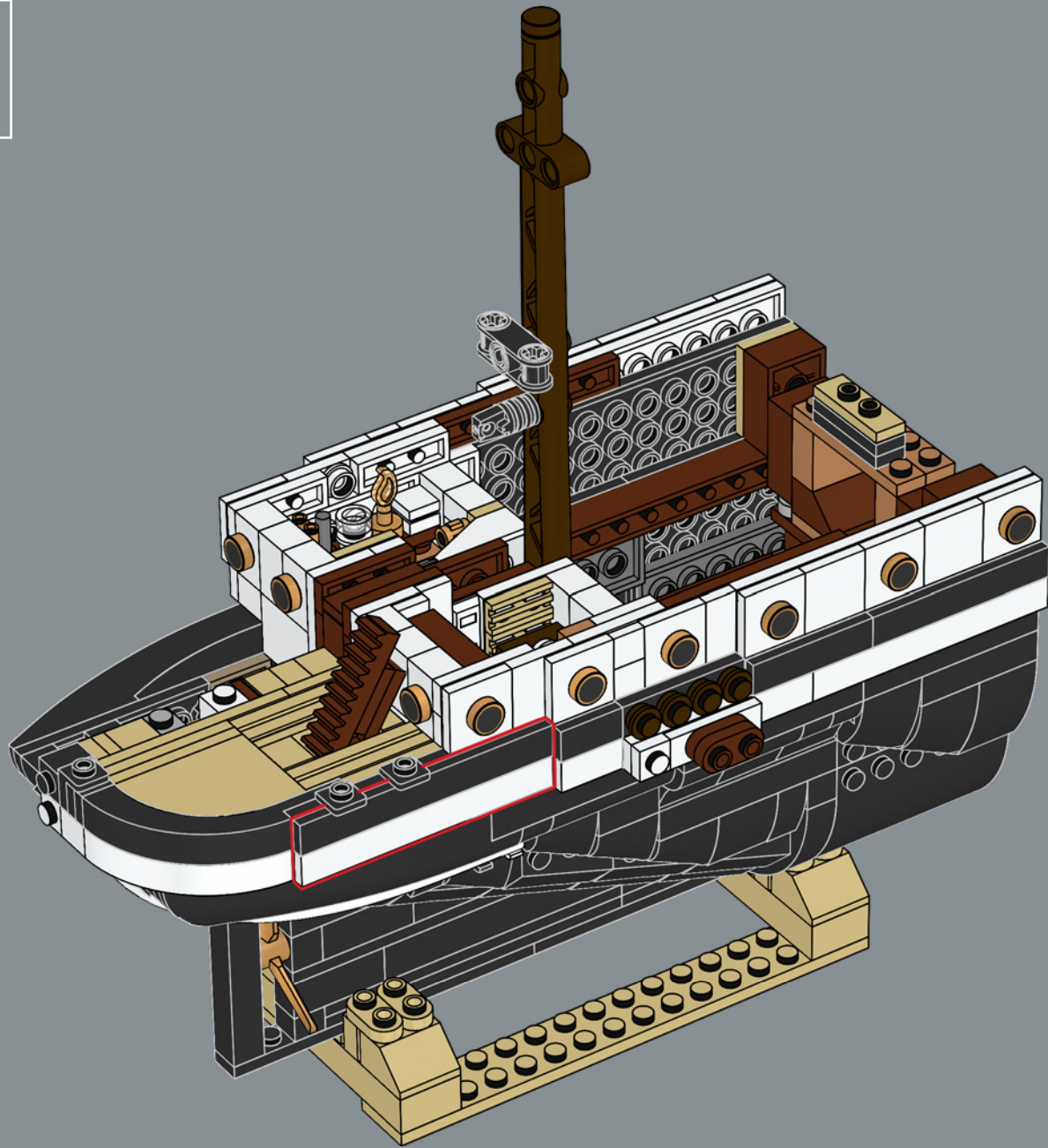

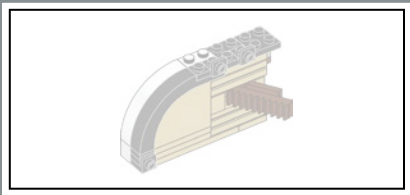

435

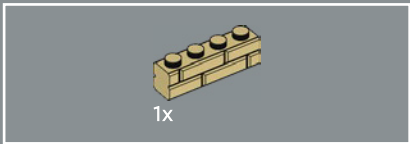
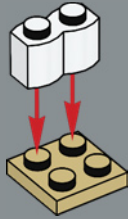

436

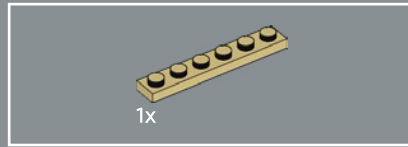
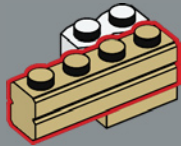

437

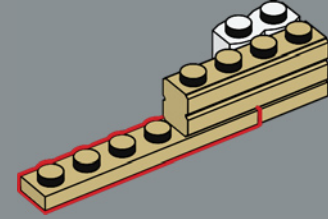

438

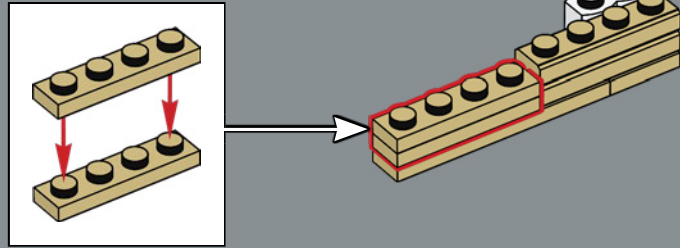

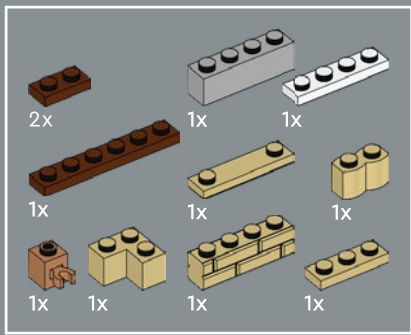

439

1

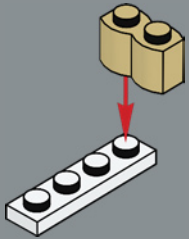

2

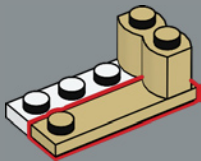

3

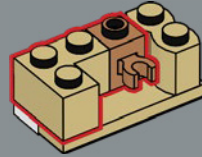

4

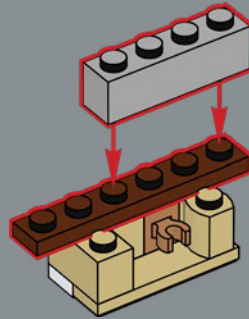

5

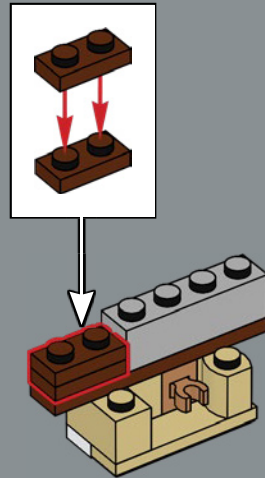

6

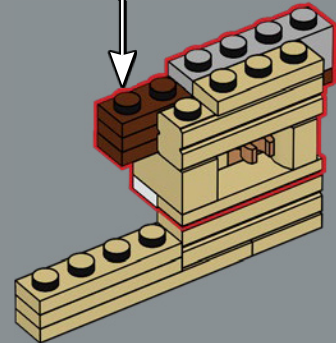
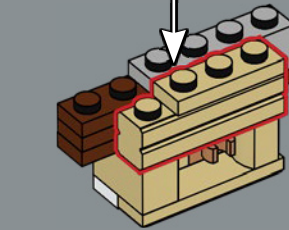
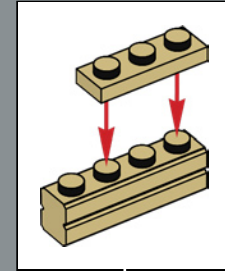

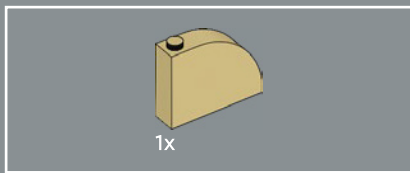

440

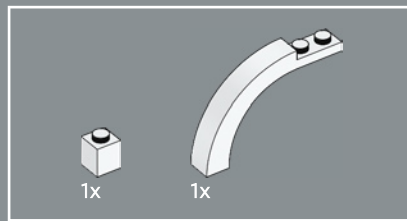
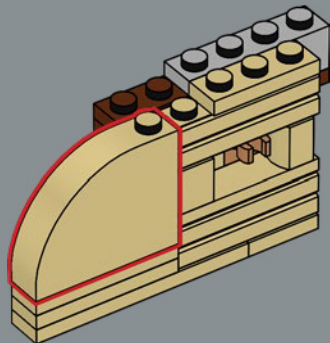

441

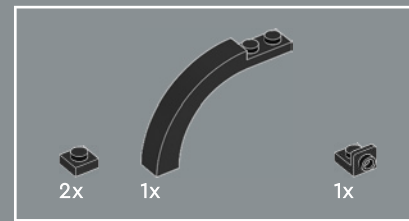
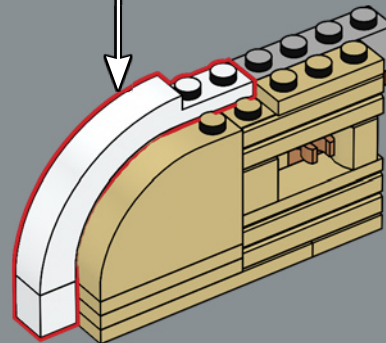
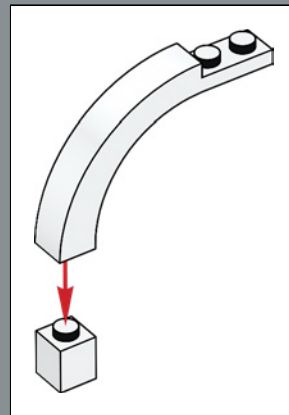

442

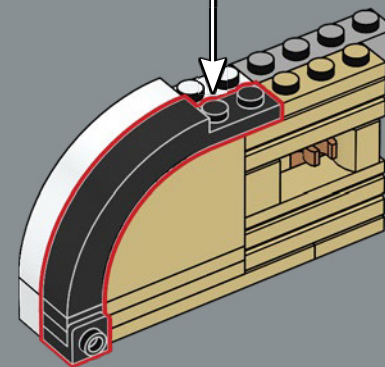
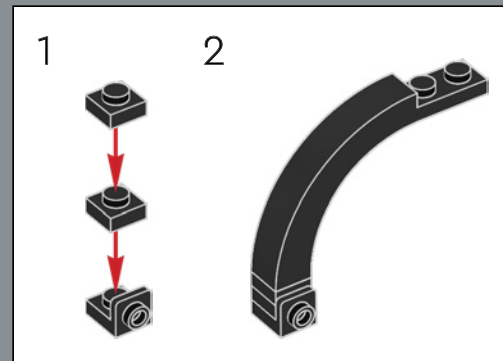

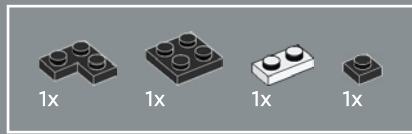

443

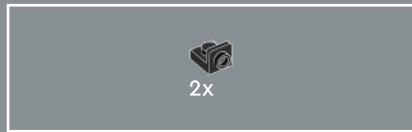
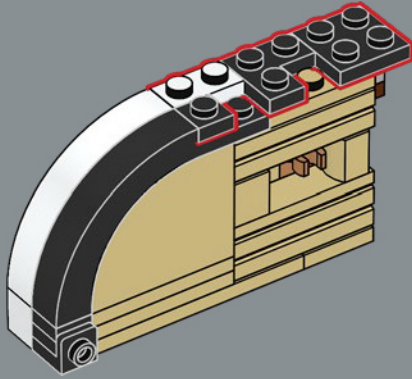

444

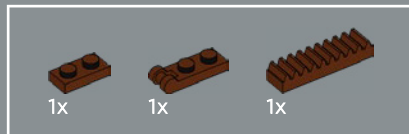
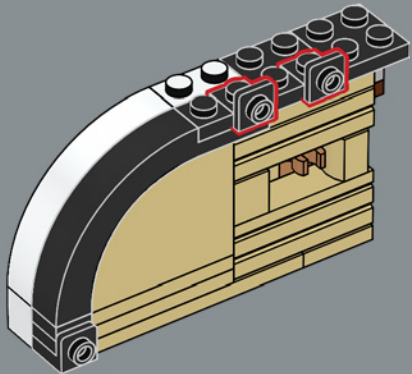

445

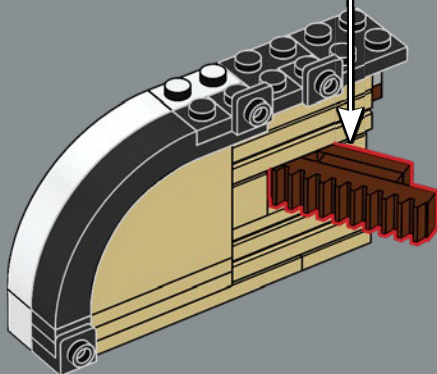
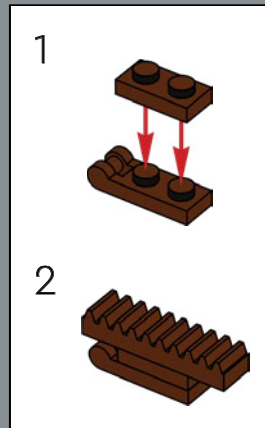

446

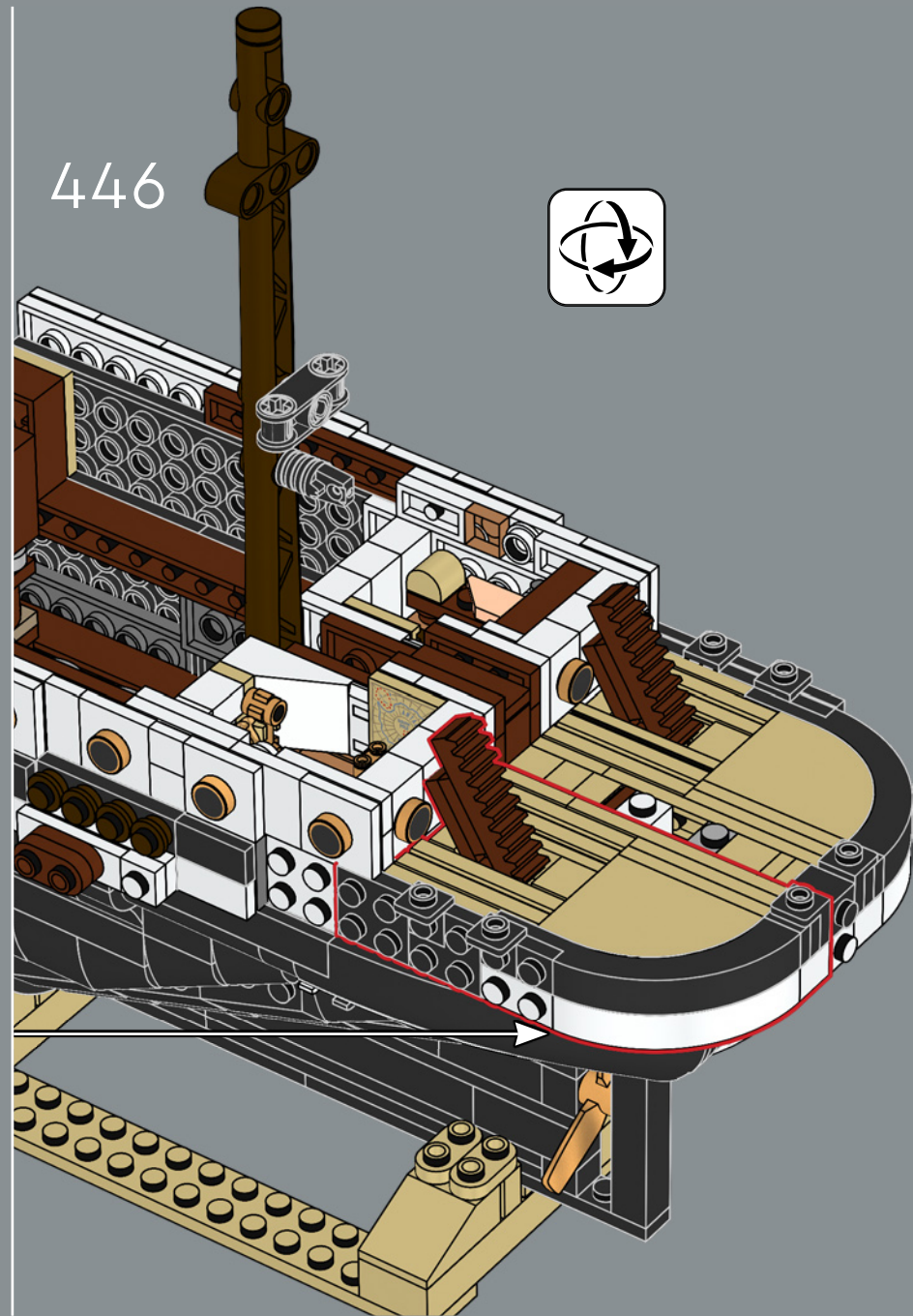

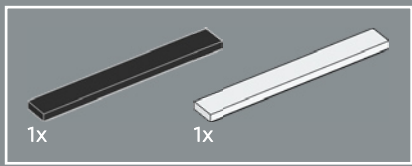

447

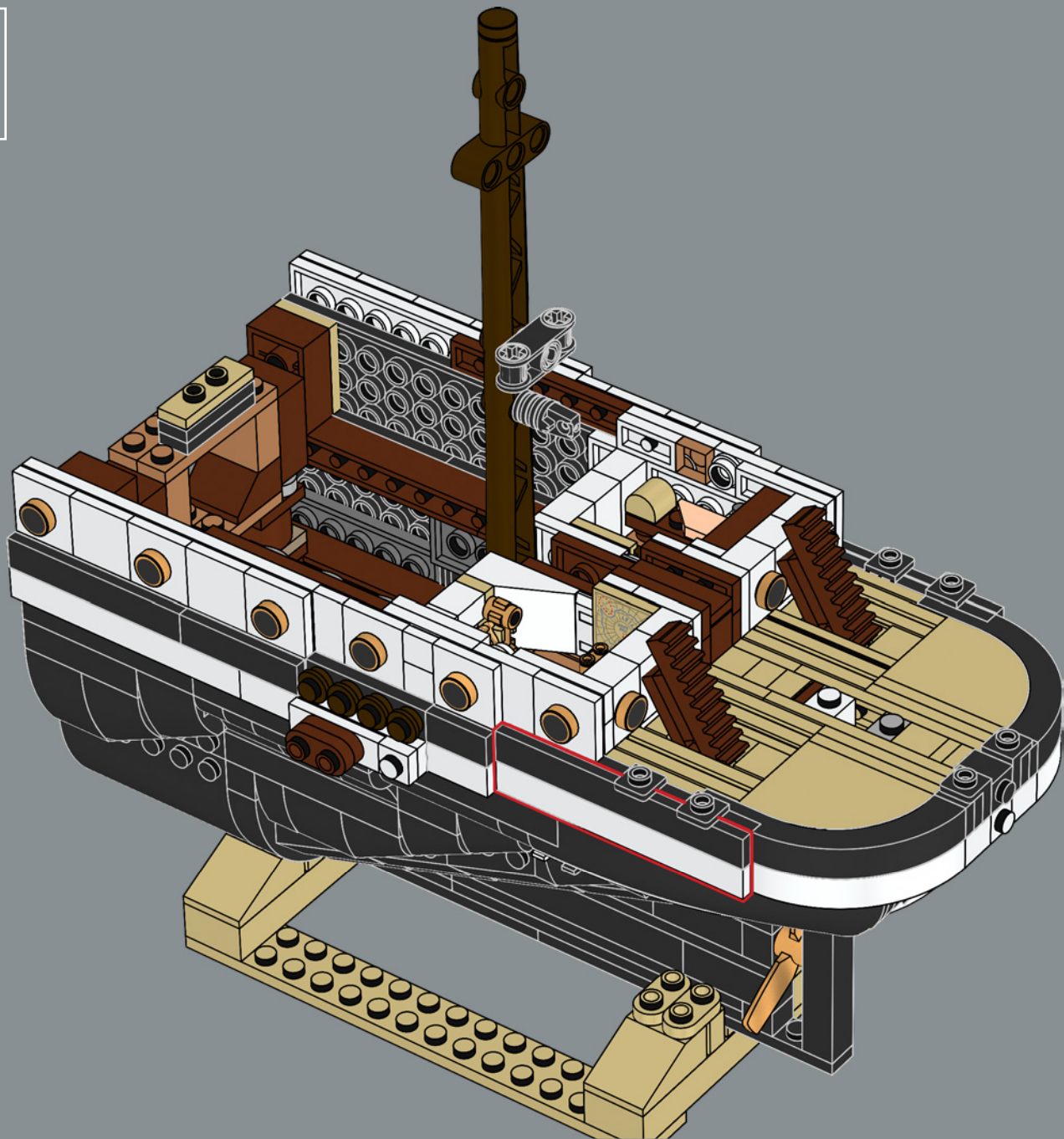

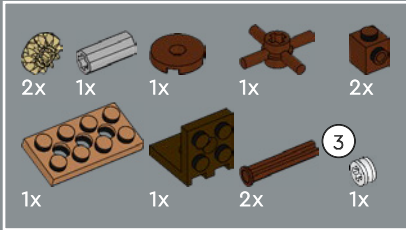
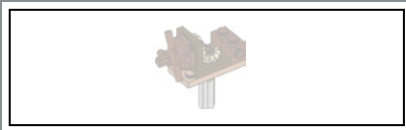

448

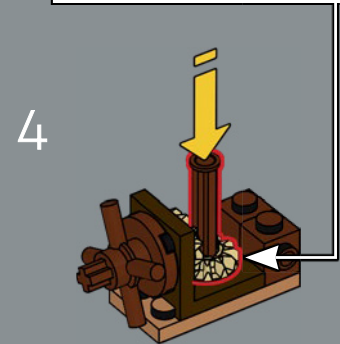
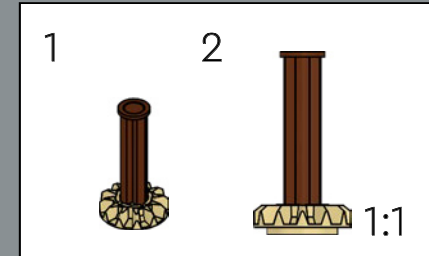
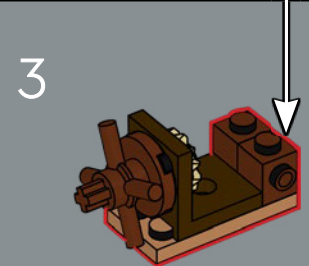
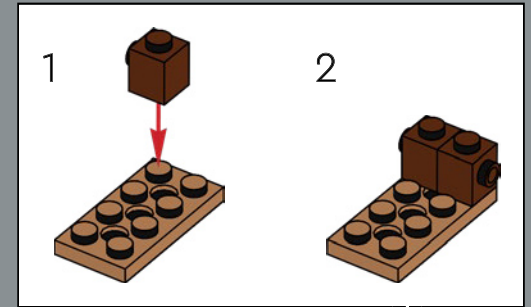
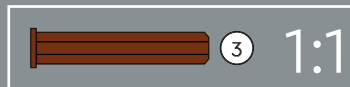
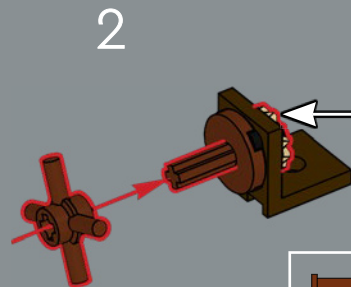
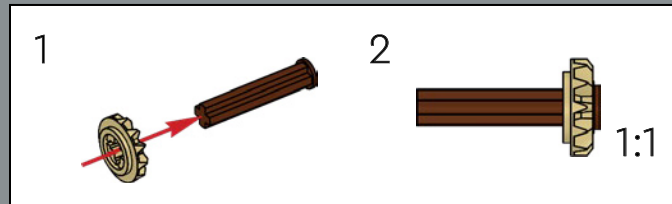
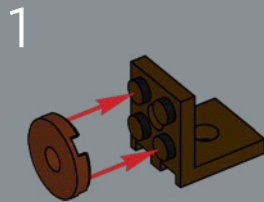

5

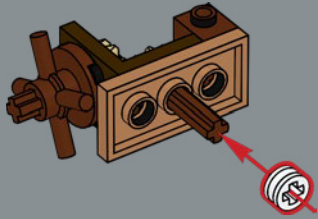

6

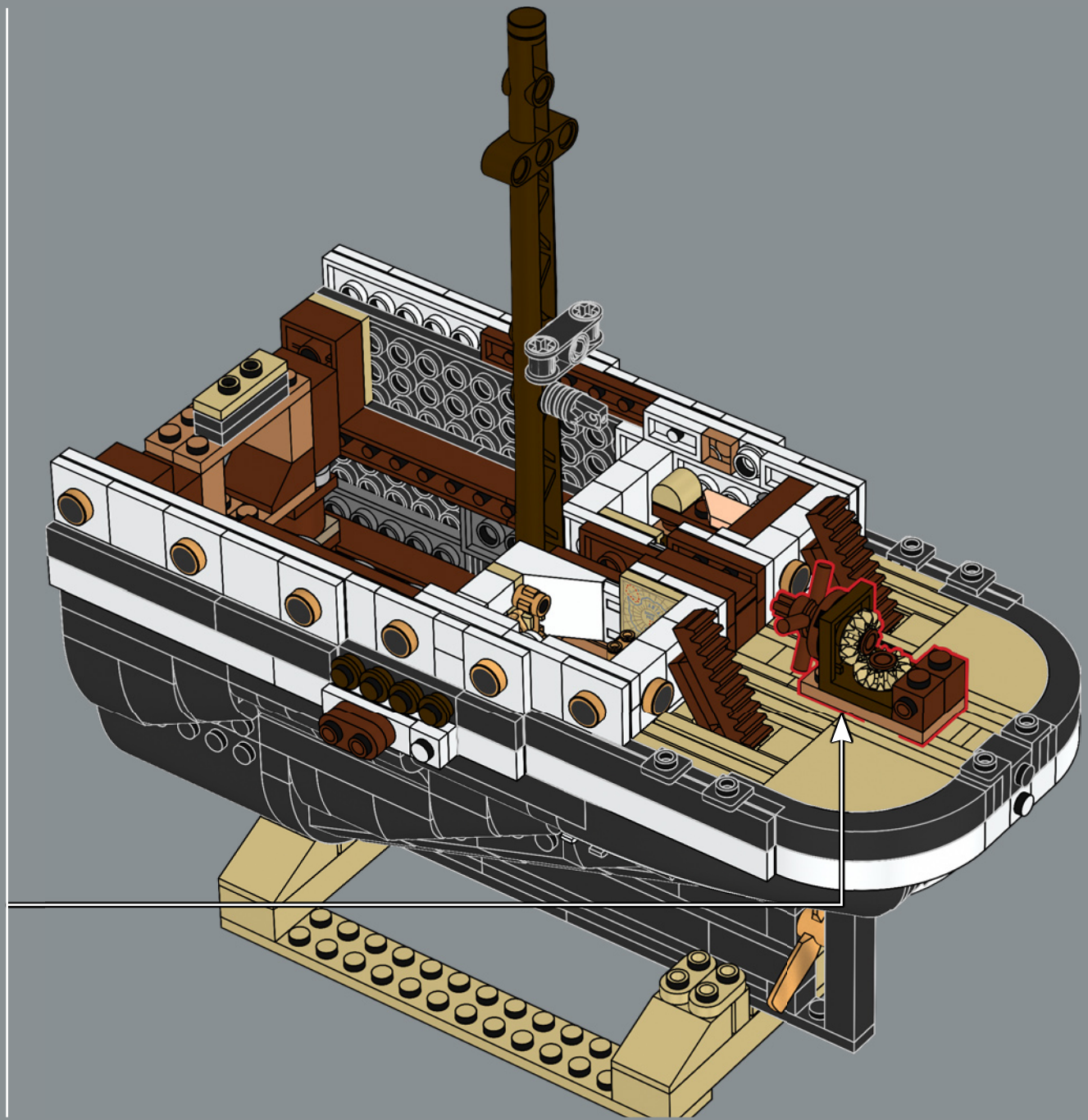
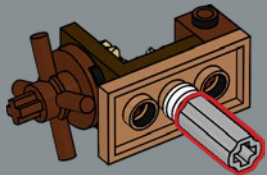

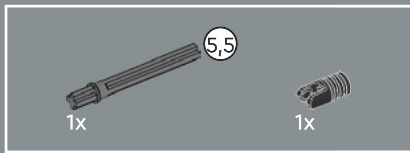

449

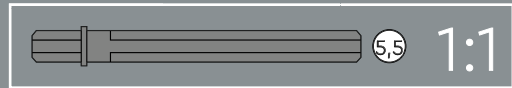
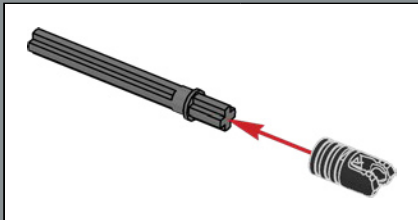
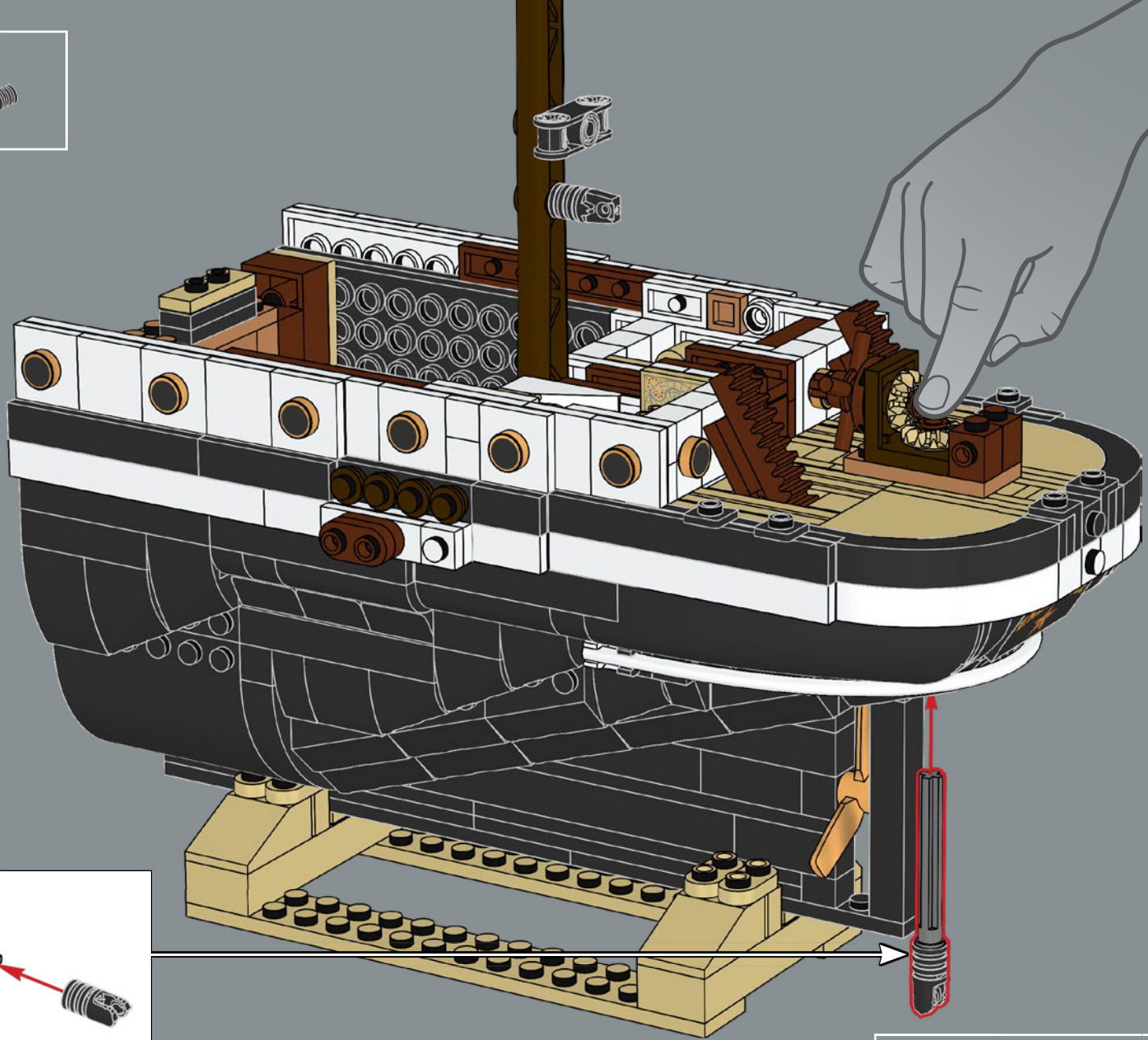

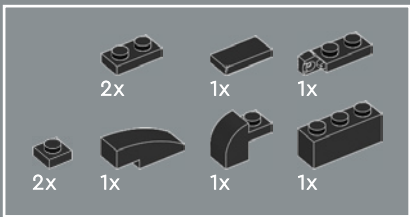

450

1

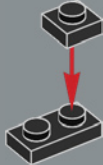

2

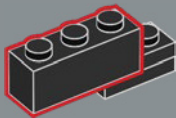

3

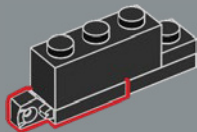

4

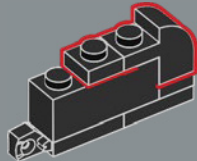

5

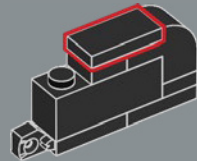

6

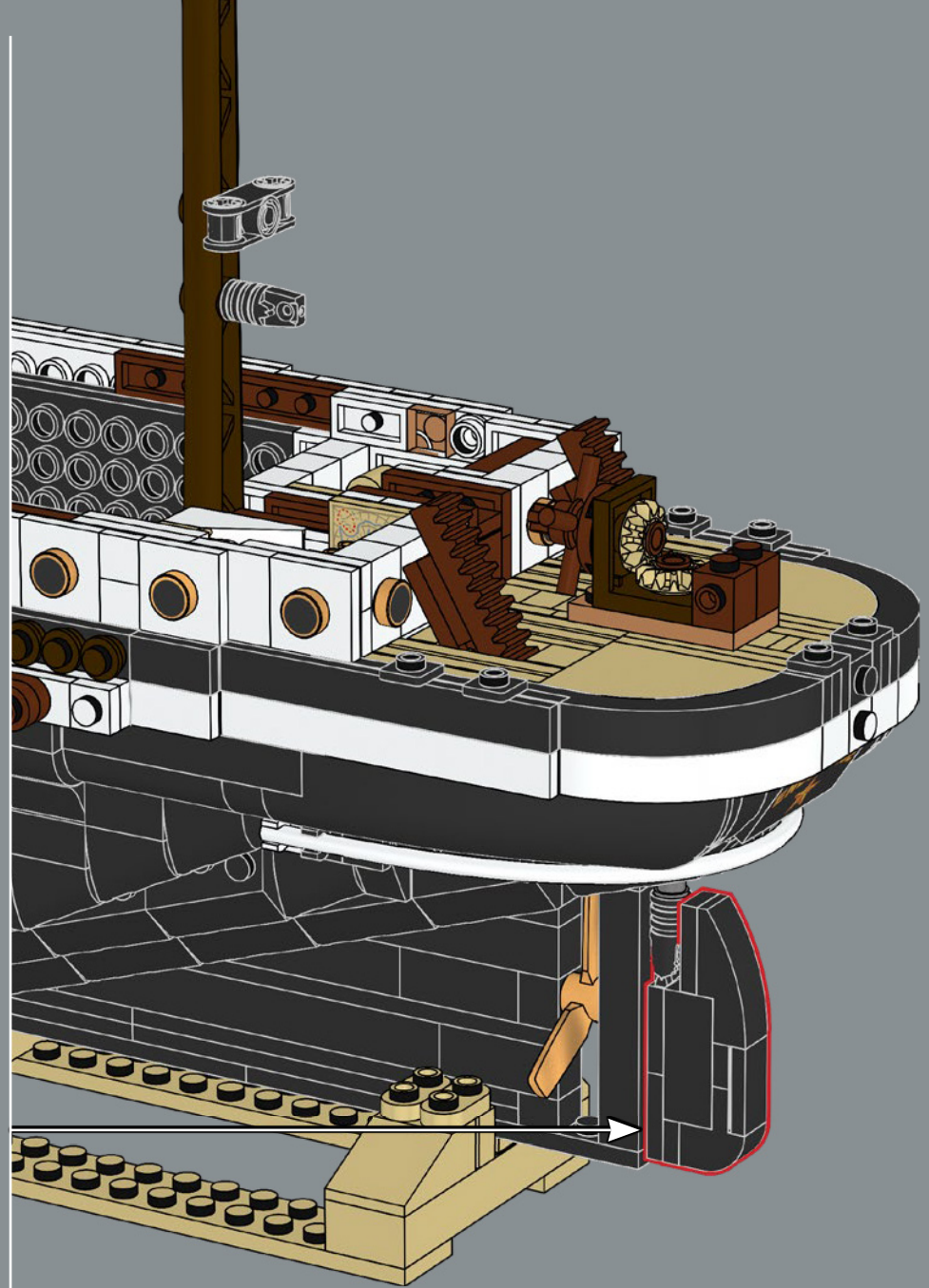
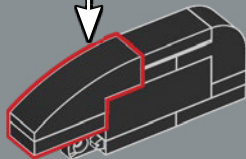
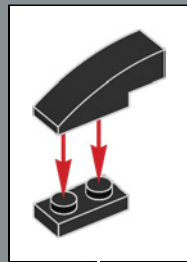

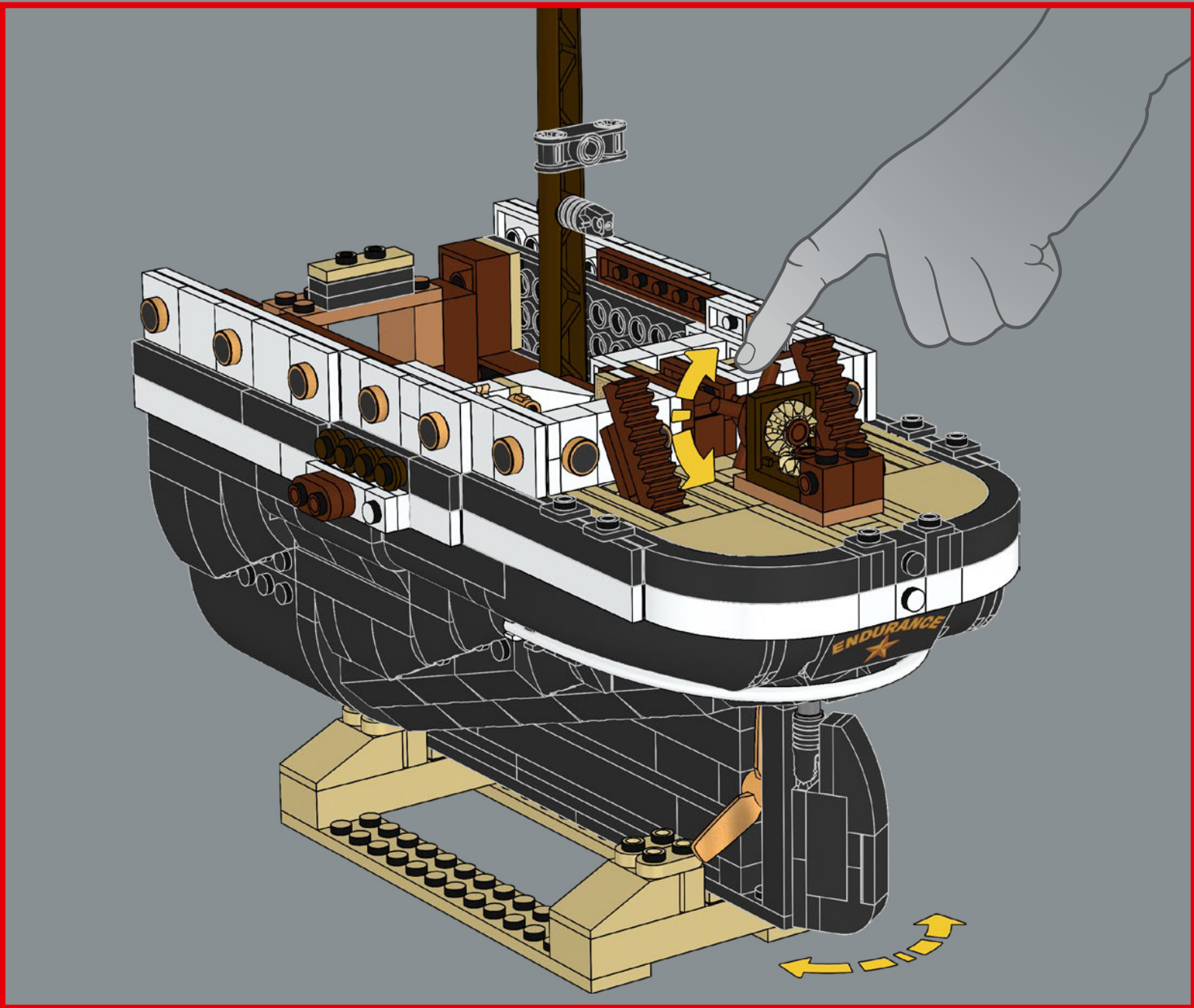

2x

451

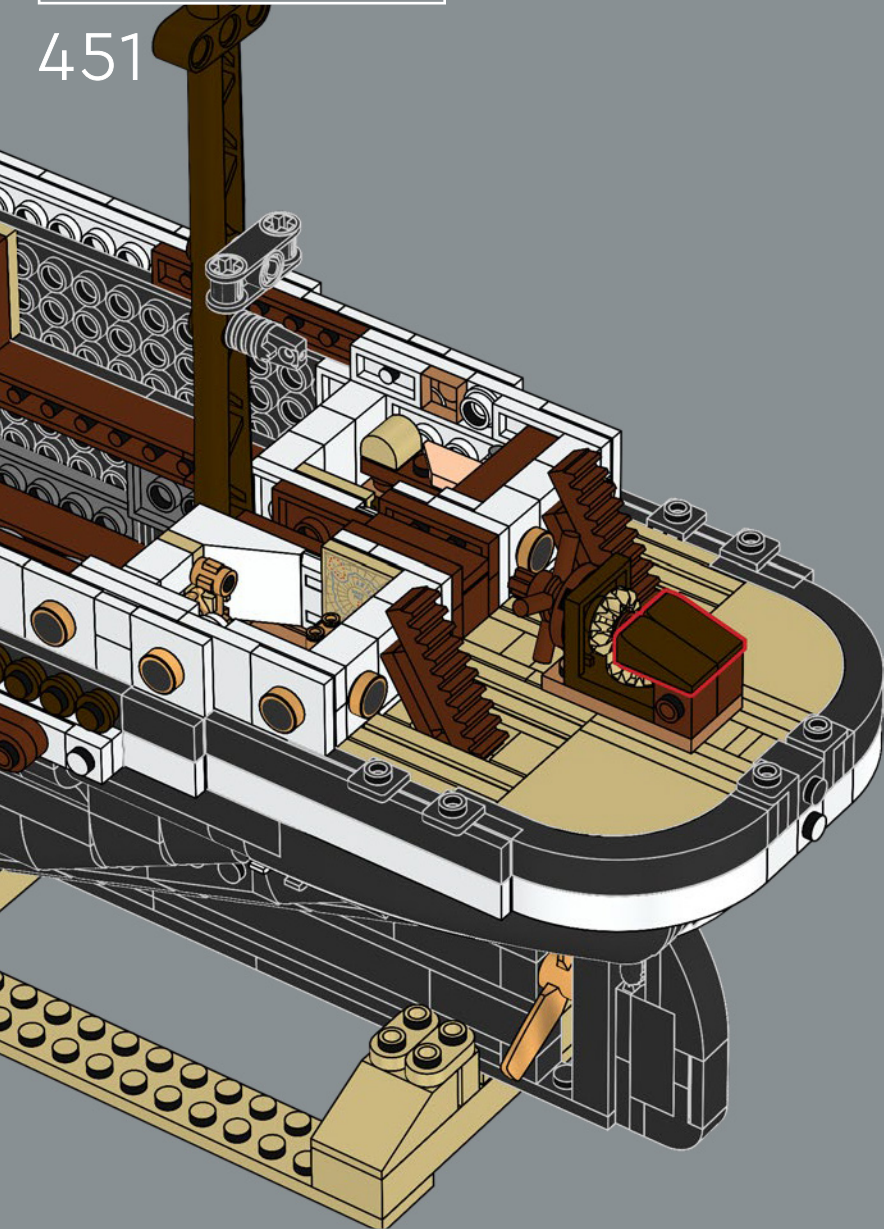

1x

1x

452

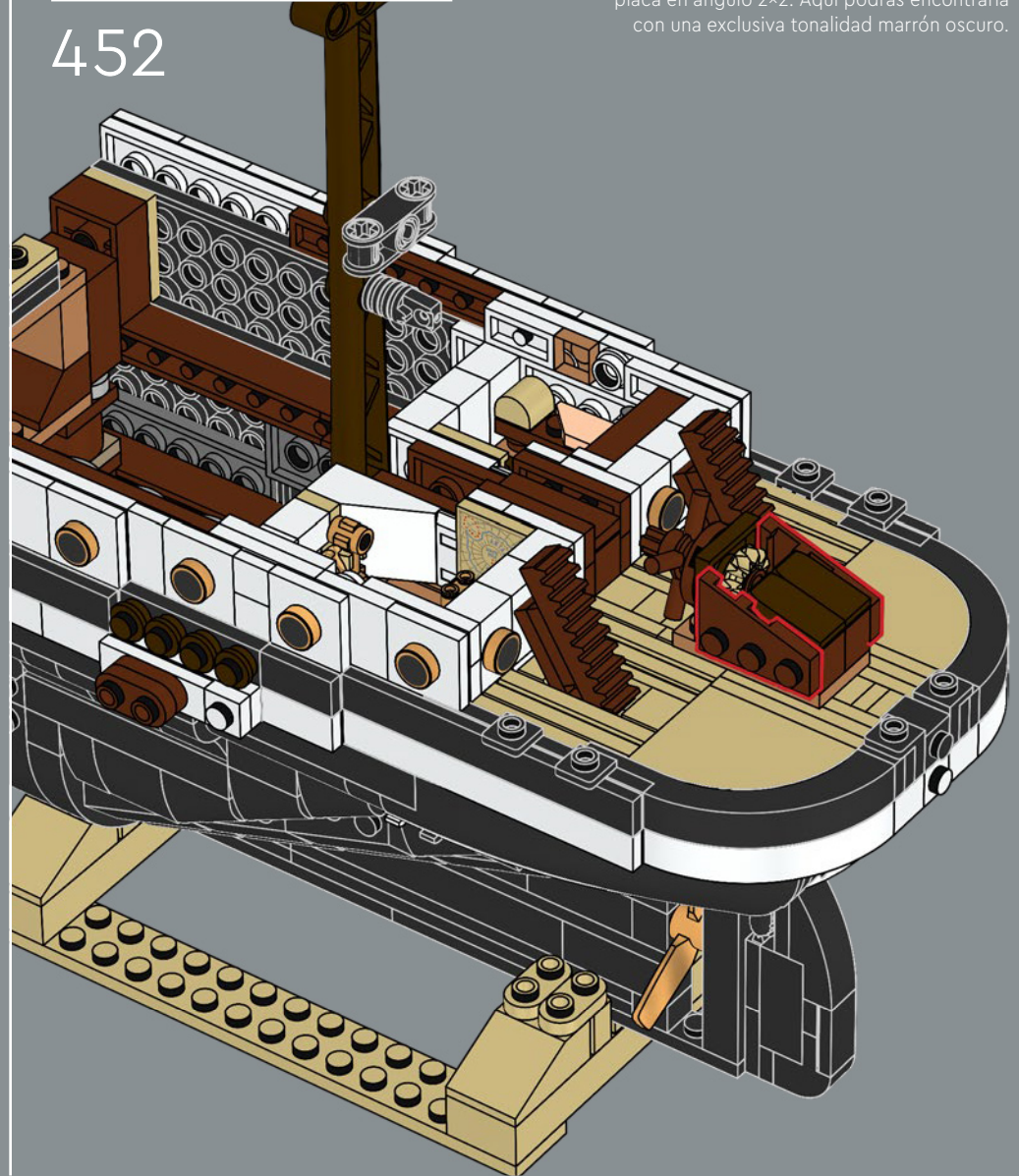

★
Para el compartimento de control del timón, diseñamos uno de los mecanismos LEGO® más pequeños de la historia basado en una original placa en ángulo 2x2. Aquí podrás encontrarla con una exclusiva tonalidad marrón oscuro.

6x

453

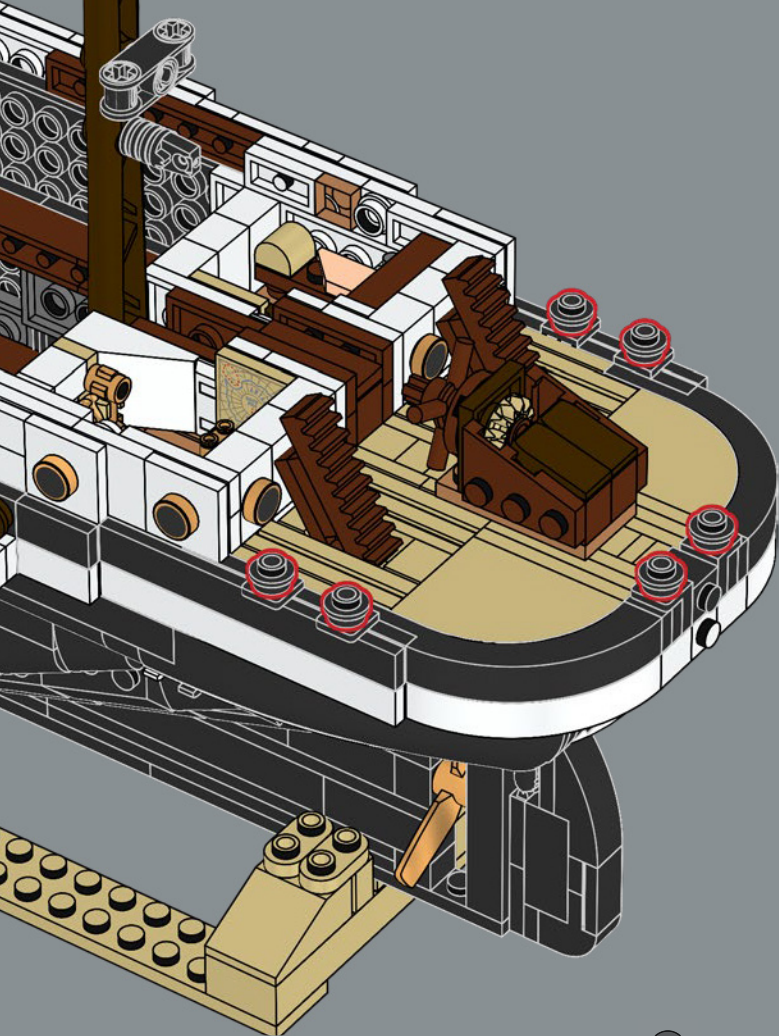

6x

454

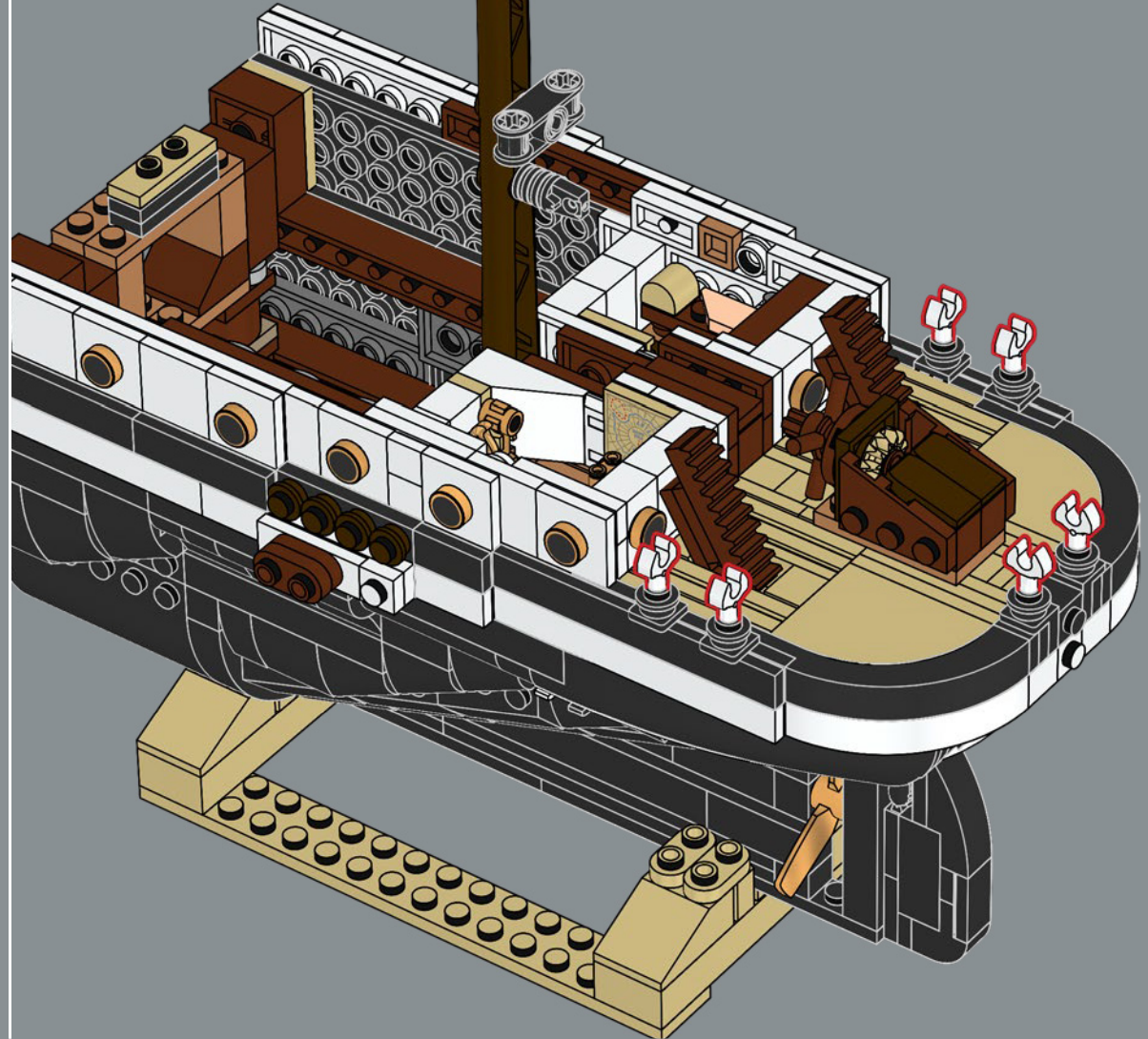

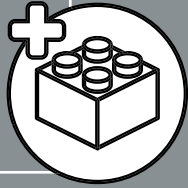
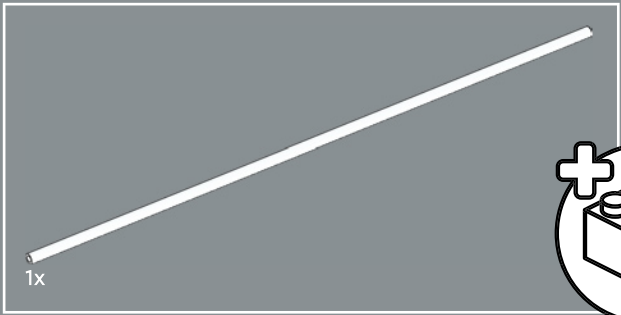

455

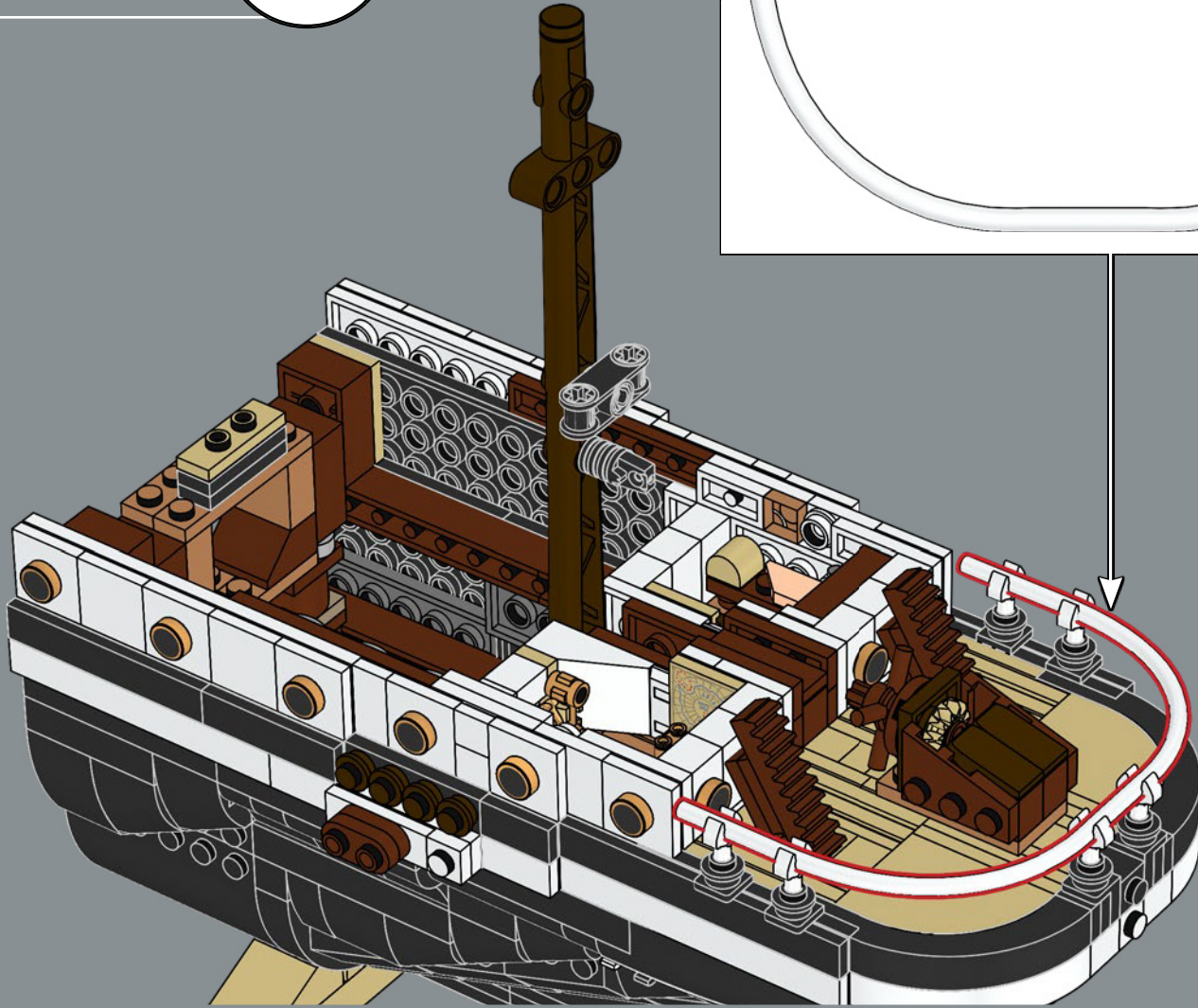
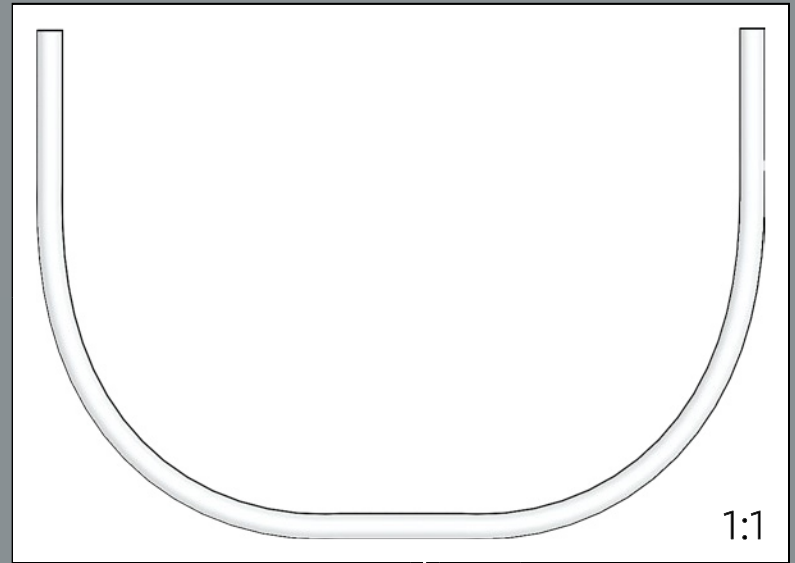



2x

456

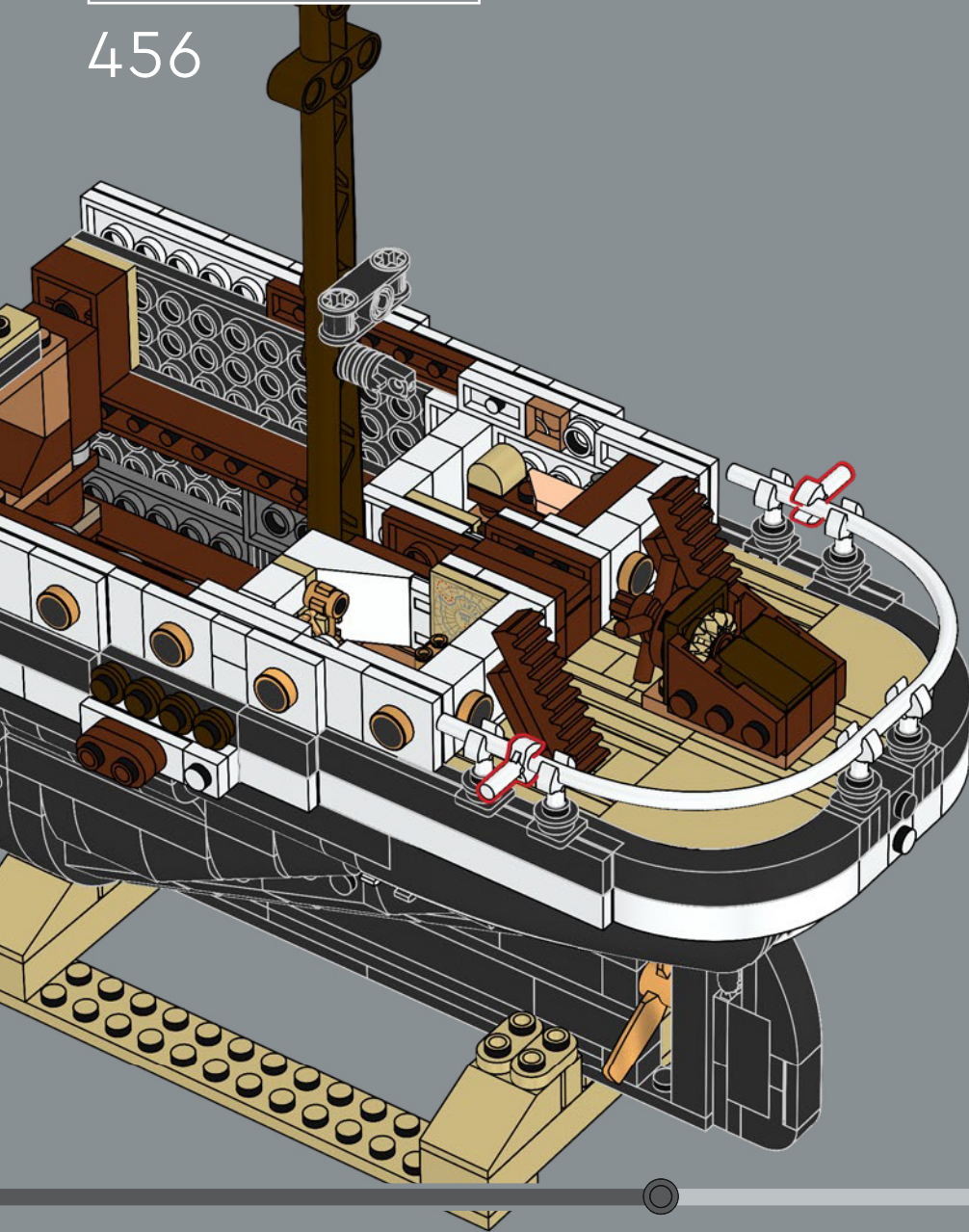

2x

457

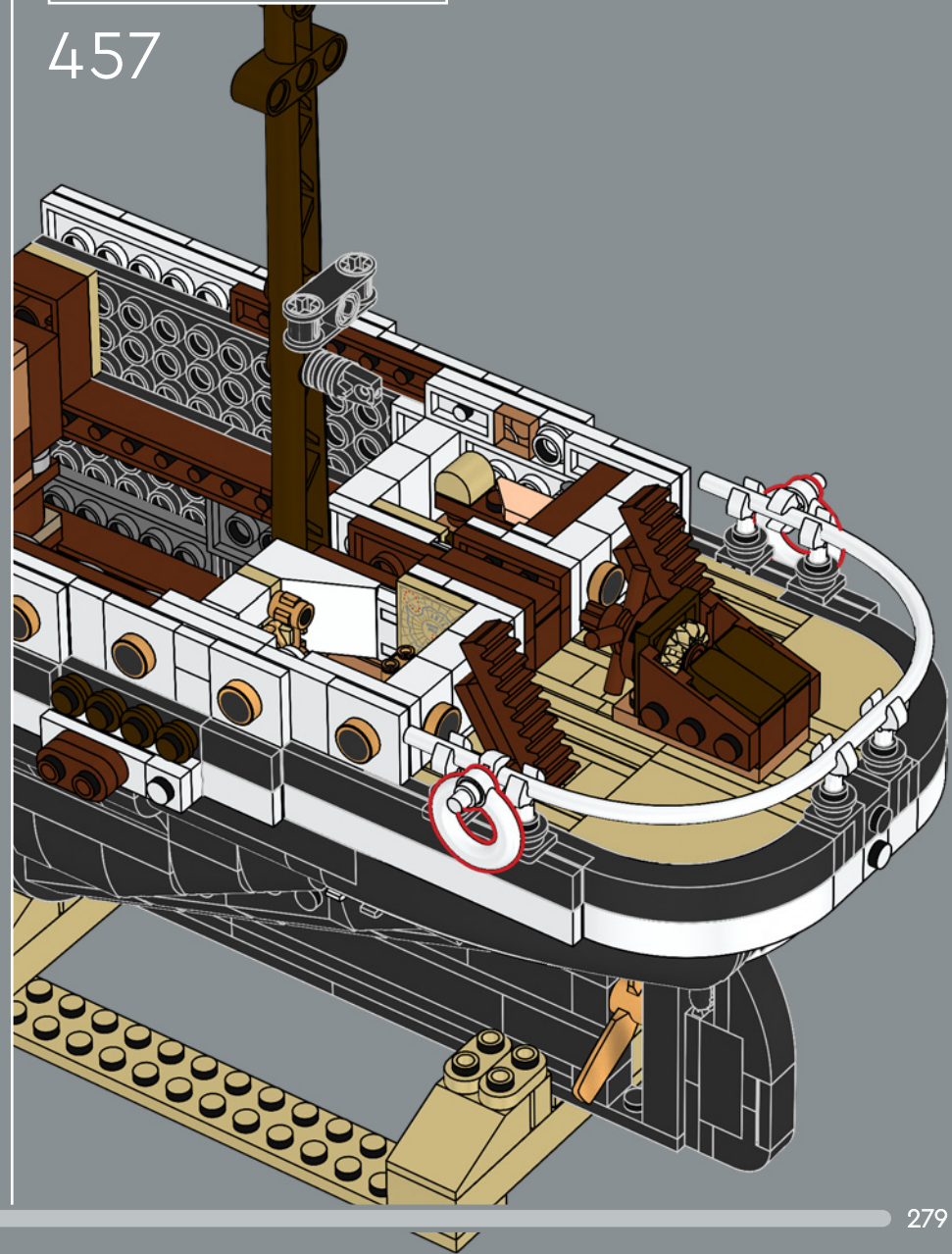

458

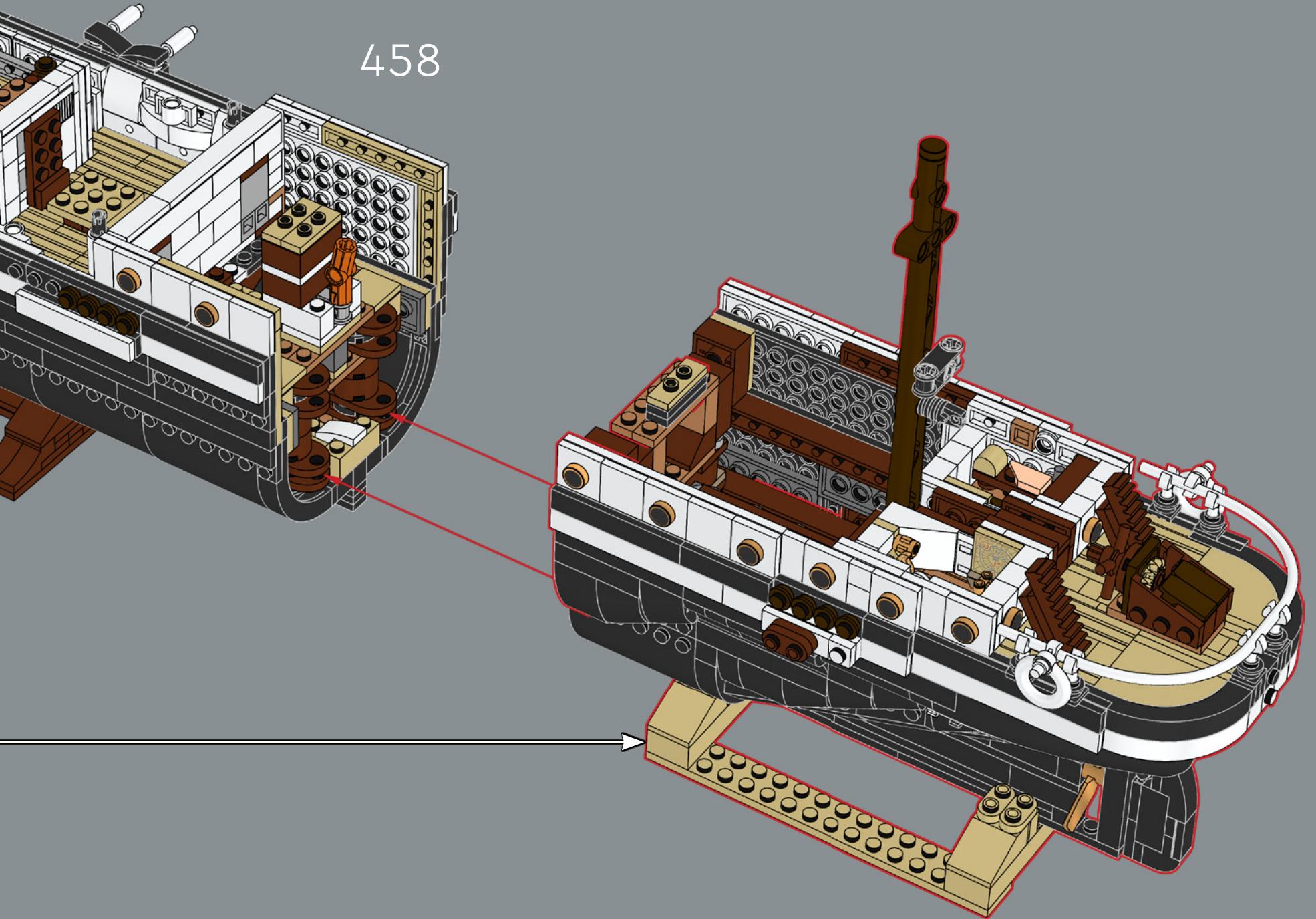

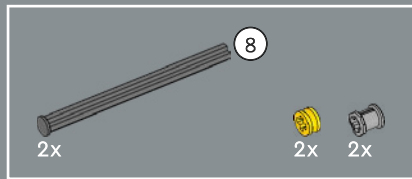

459

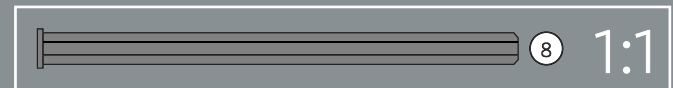
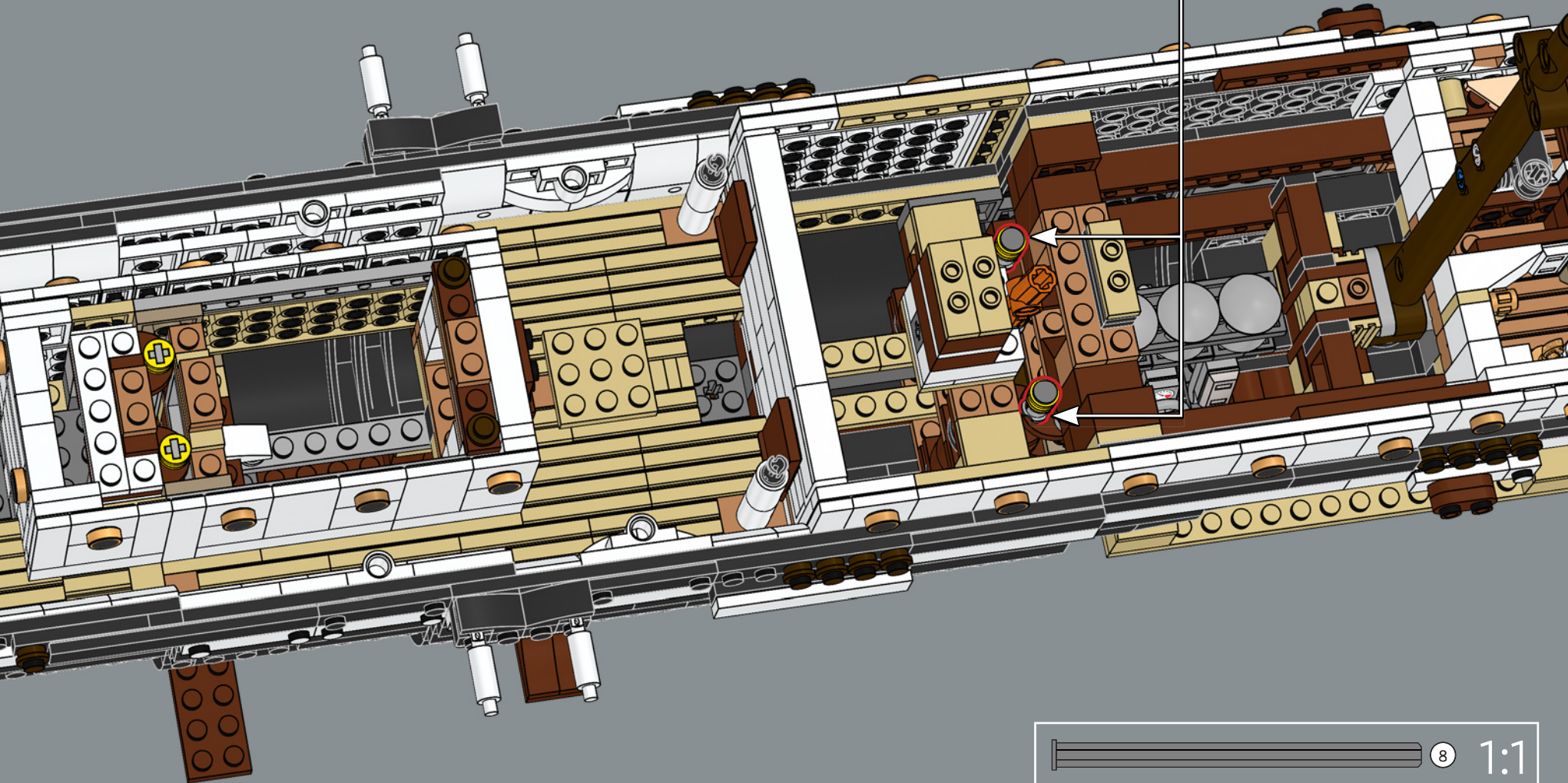
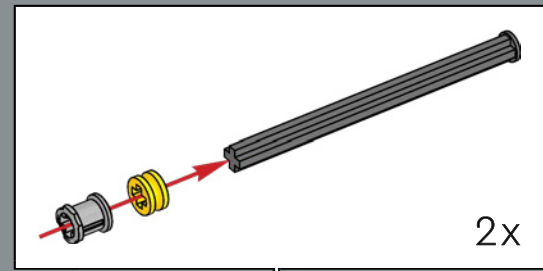

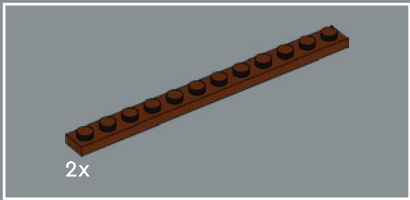

2x

460

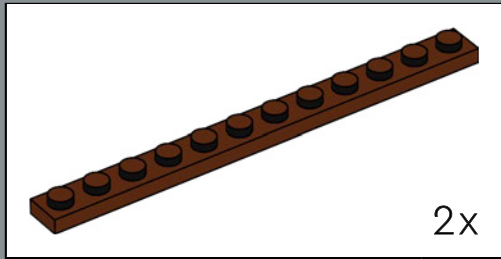

2x

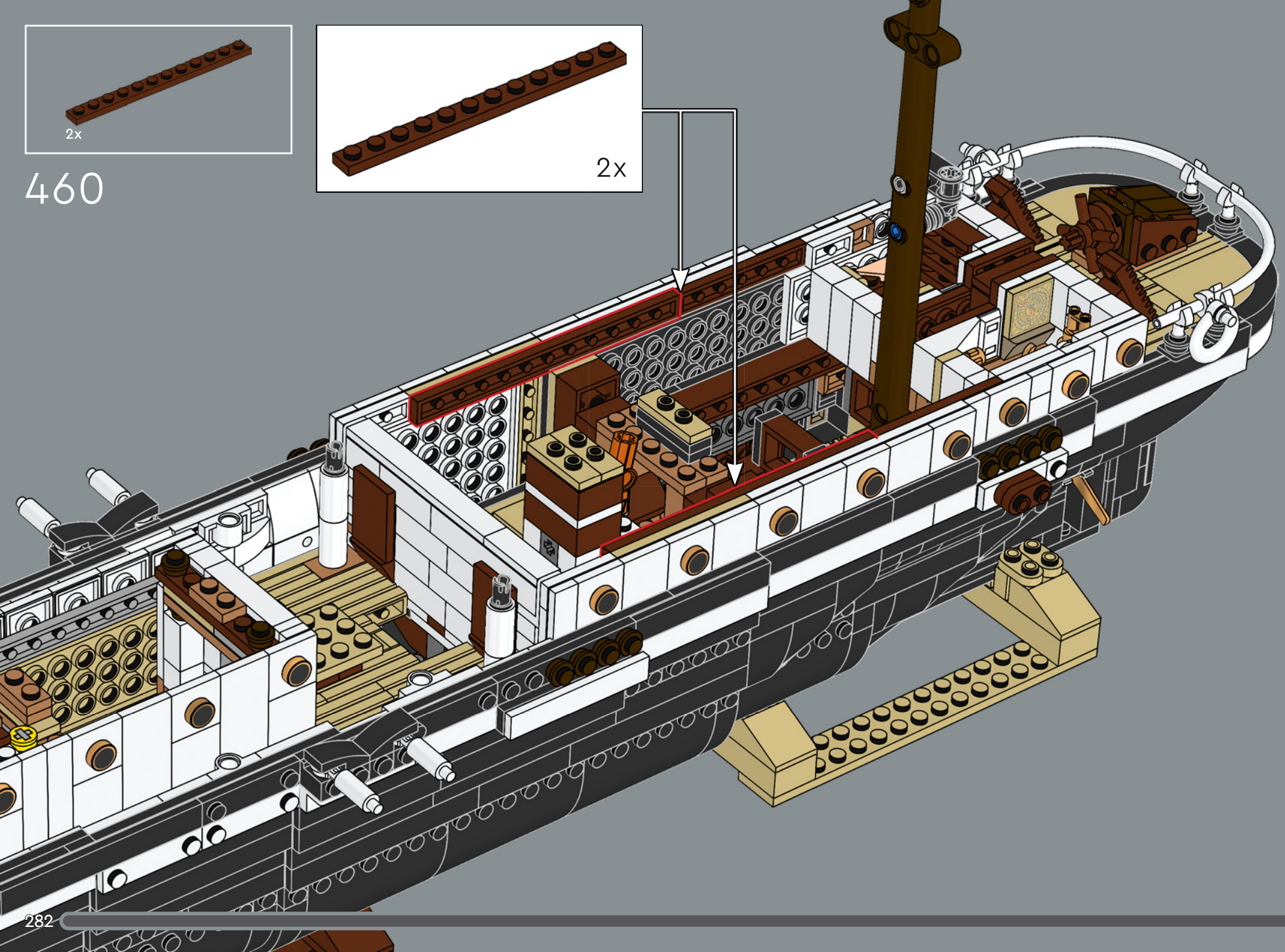

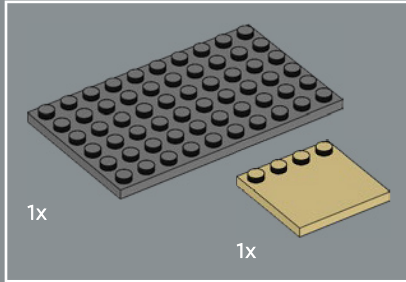
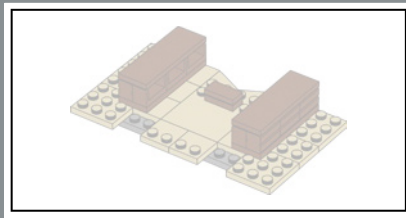

461

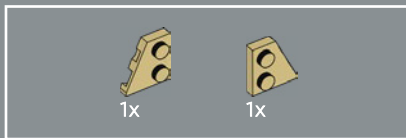
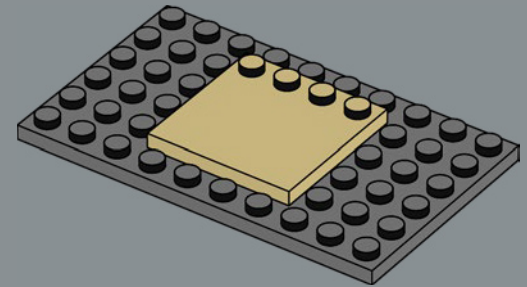

462

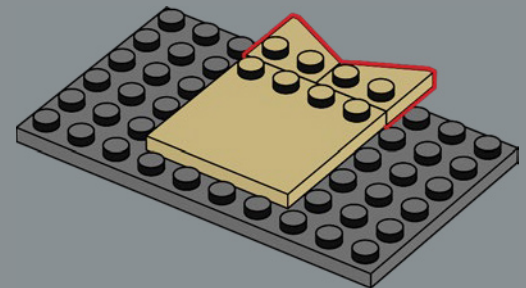

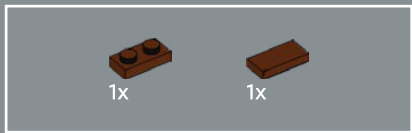

463

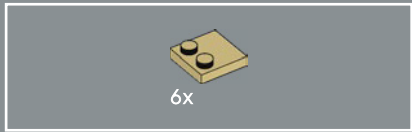
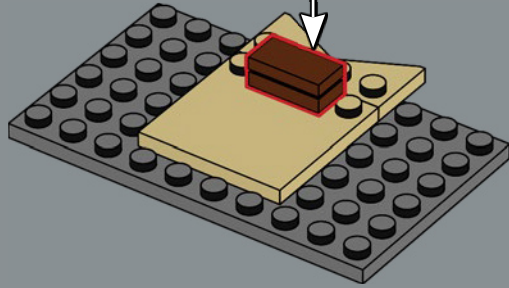
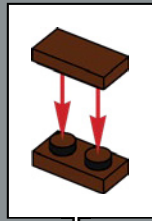

464

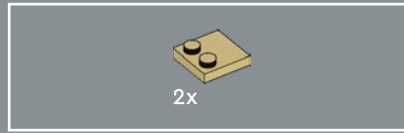
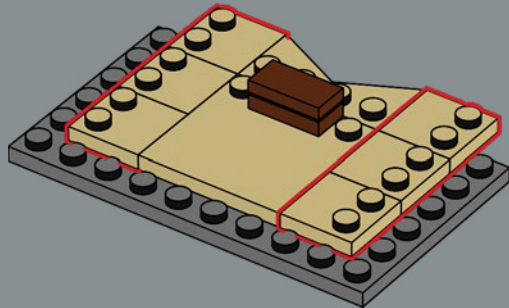

465

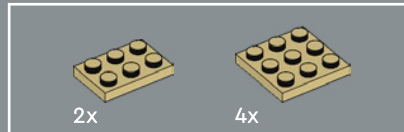
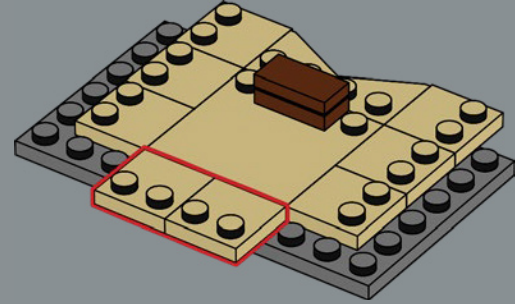

466

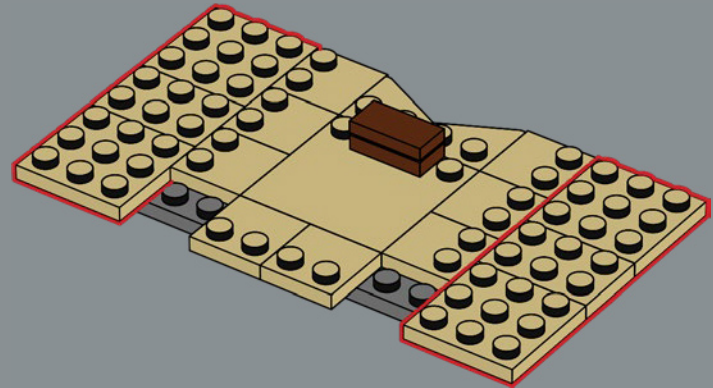

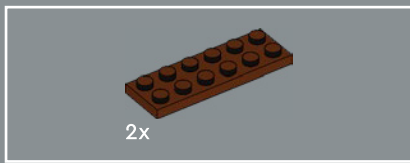

467

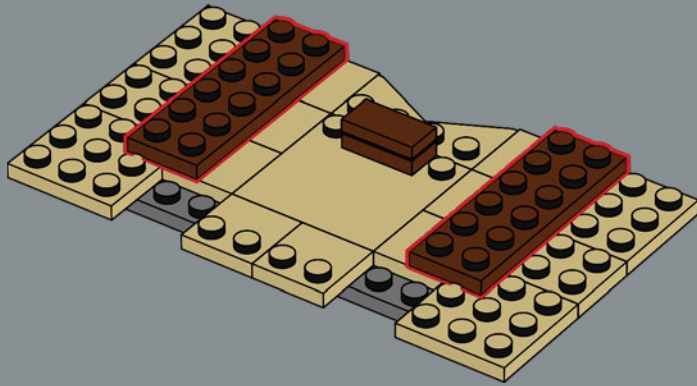

468

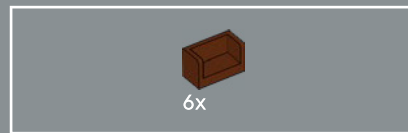
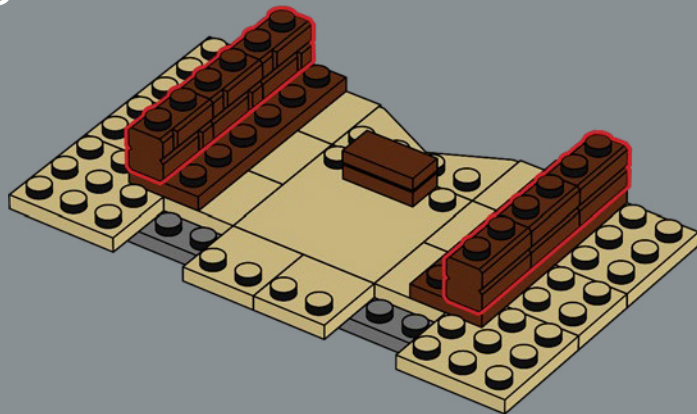

469

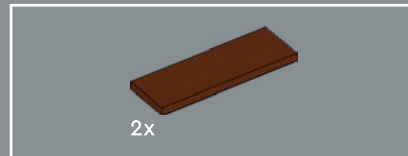
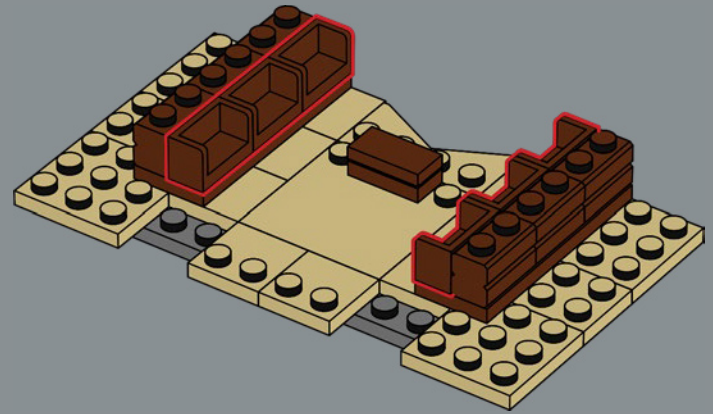

470

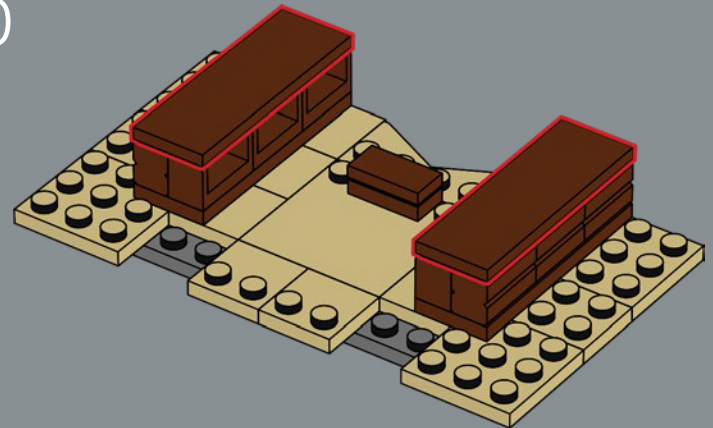

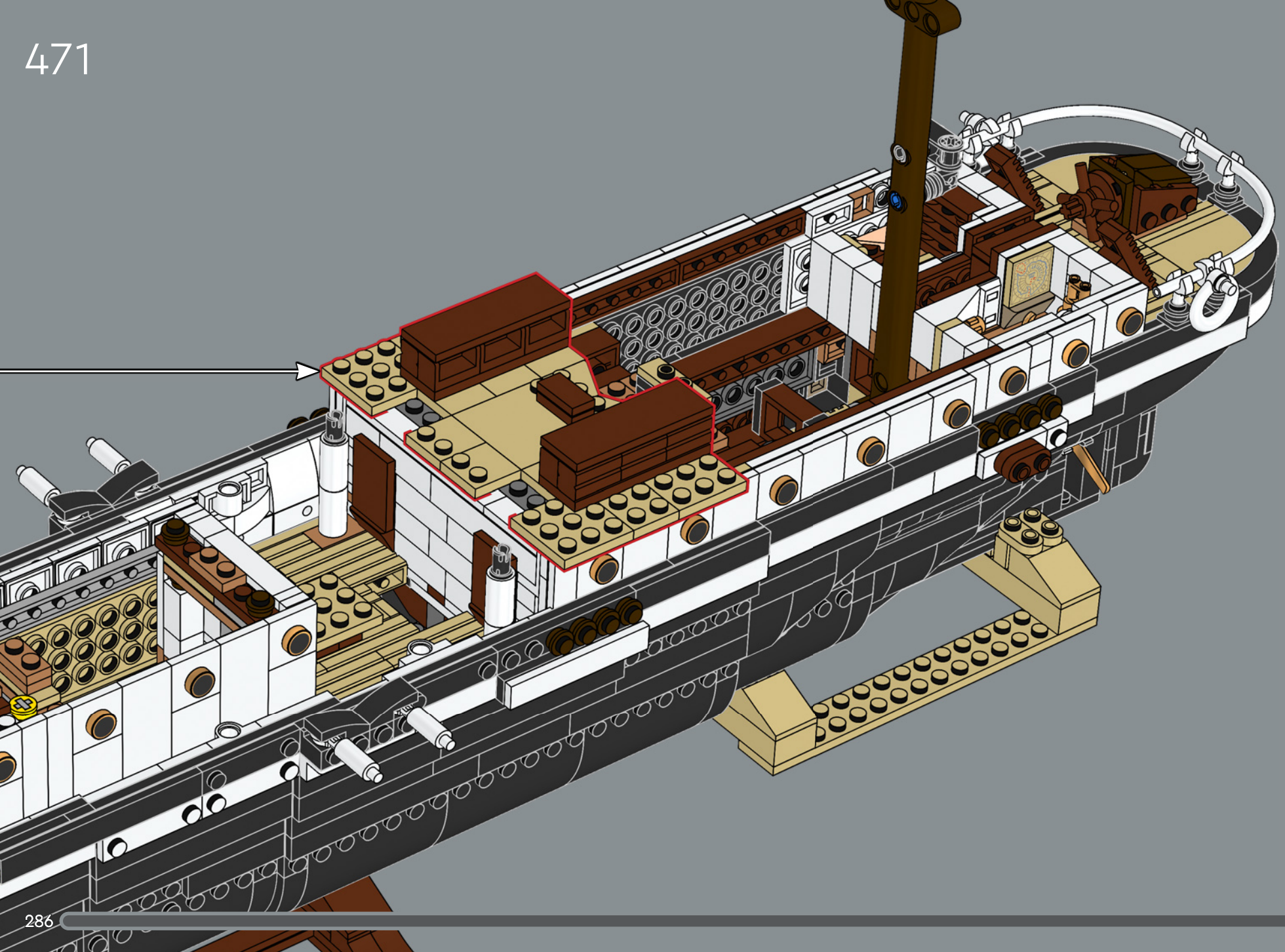

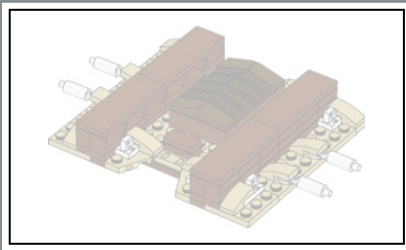

472

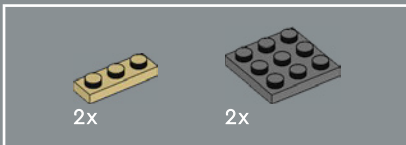
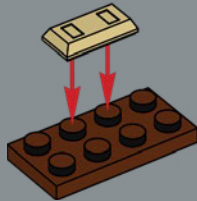

473

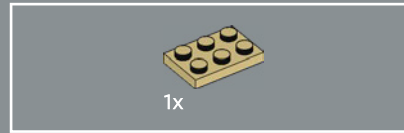
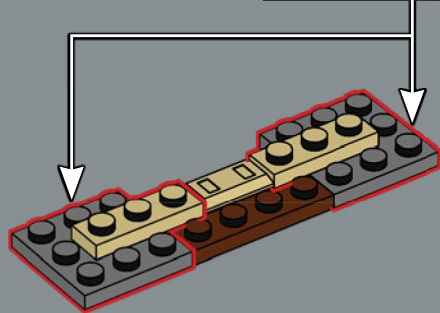
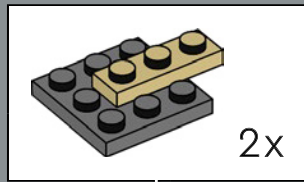

474

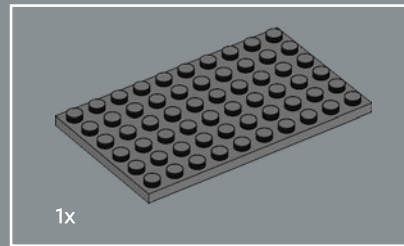
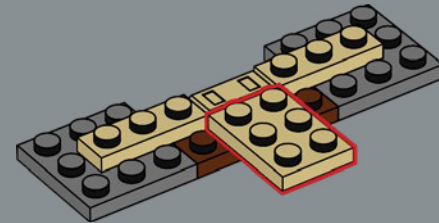

475

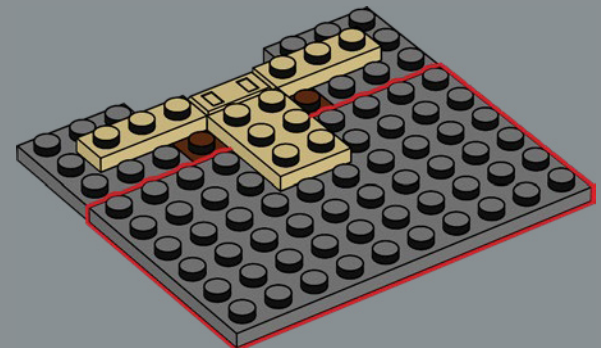

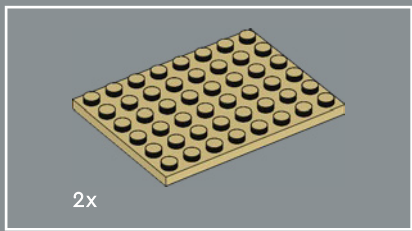

476

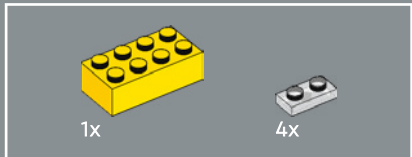
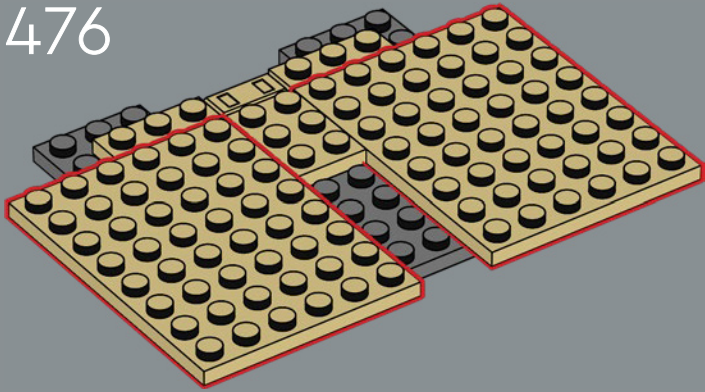

477

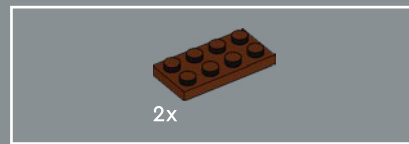
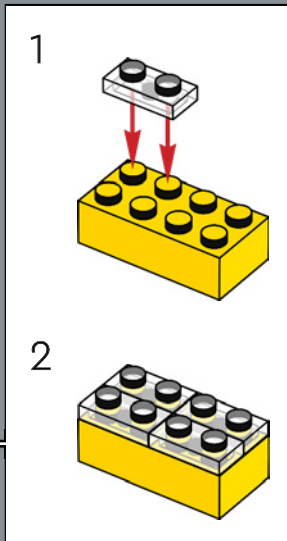
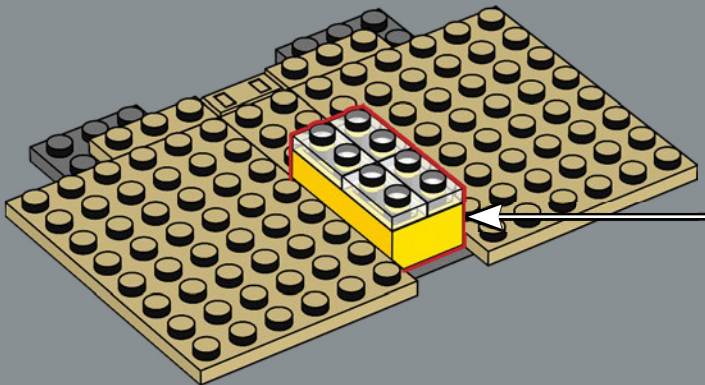

478

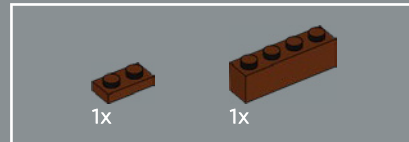
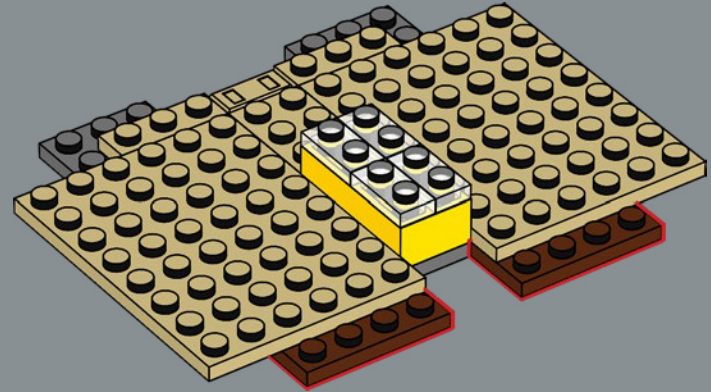

479

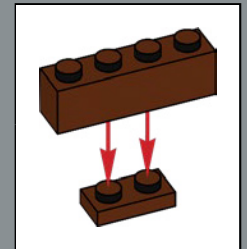
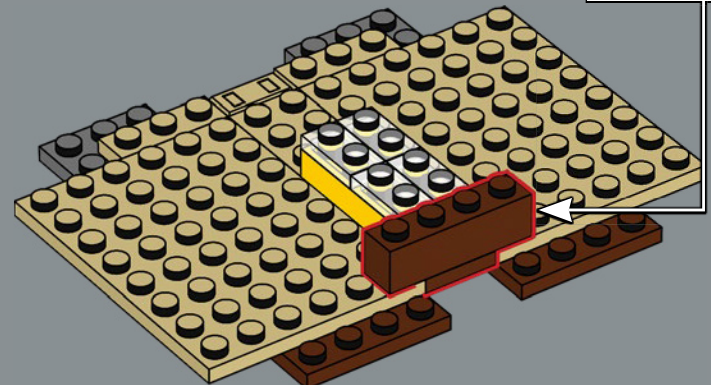

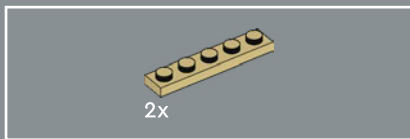

480

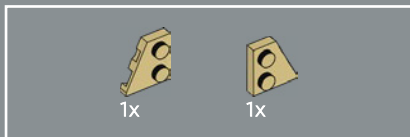
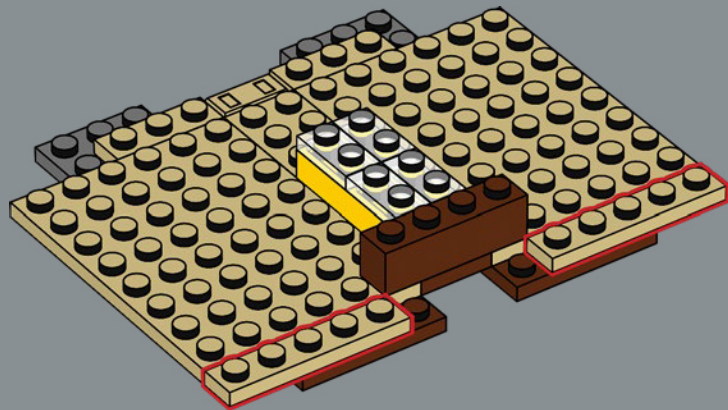

481

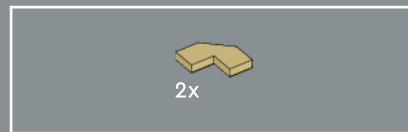
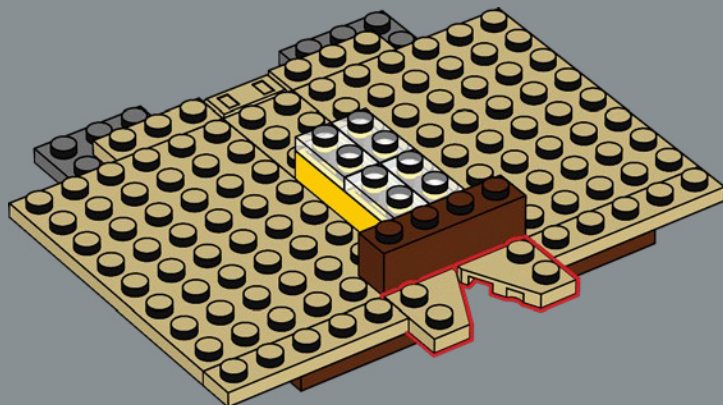

482

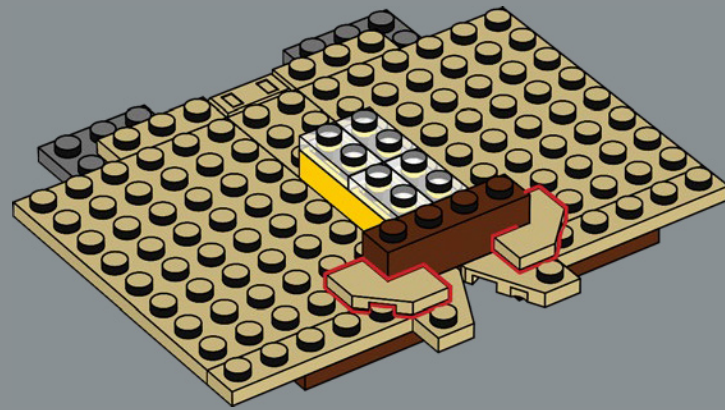

483

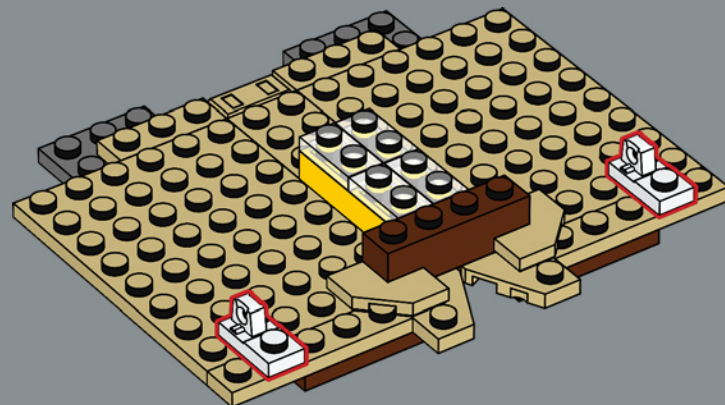



2x

484

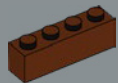
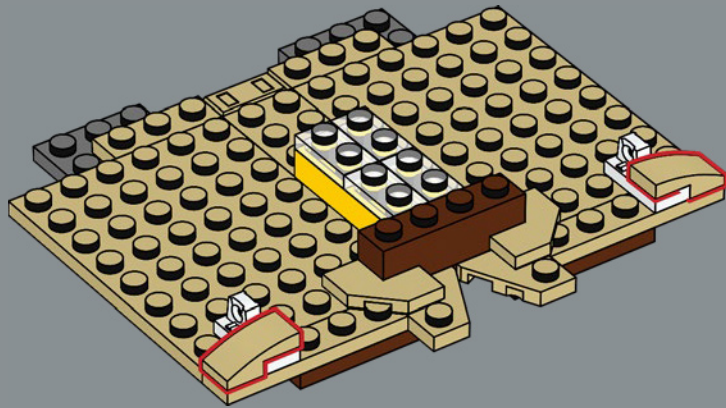

3x

485

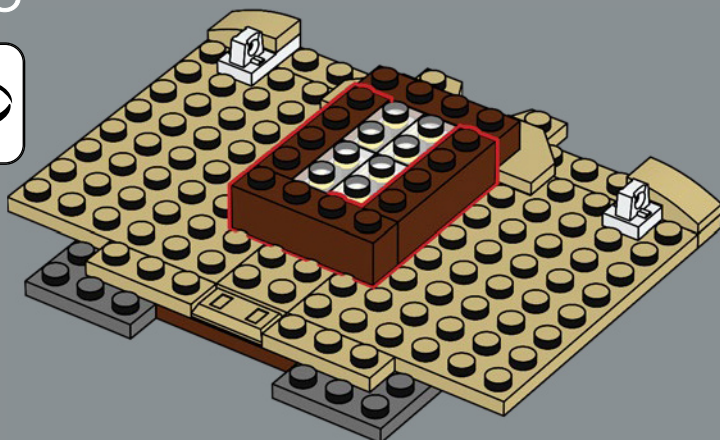

4x



8x

486

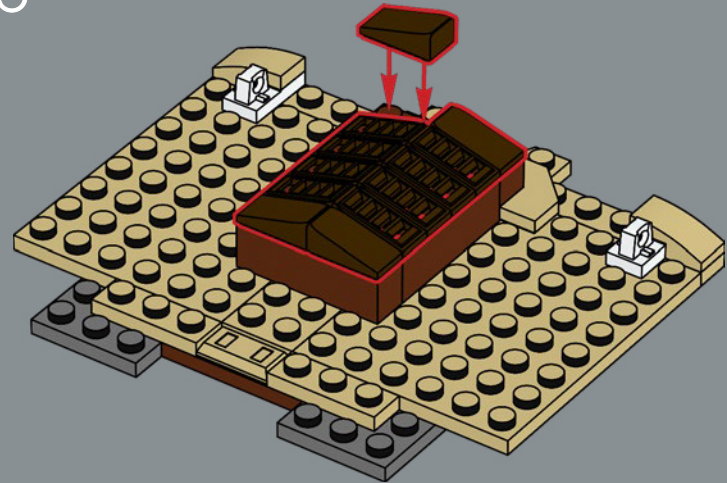

Para dar a la parte superior de los camarotes del modelo un aspecto más robusto, se fabricaron por primera vez en marrón oscuro pequeños elementos con pendiente 1x2 para sus techos.

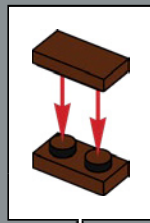
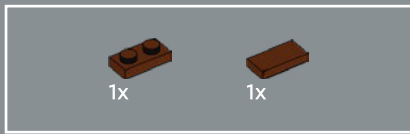

487

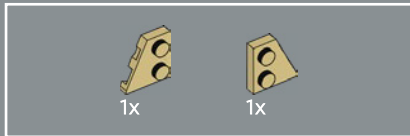
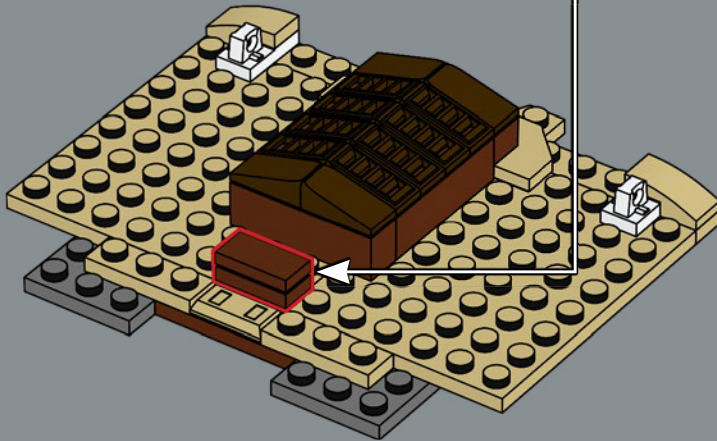

488

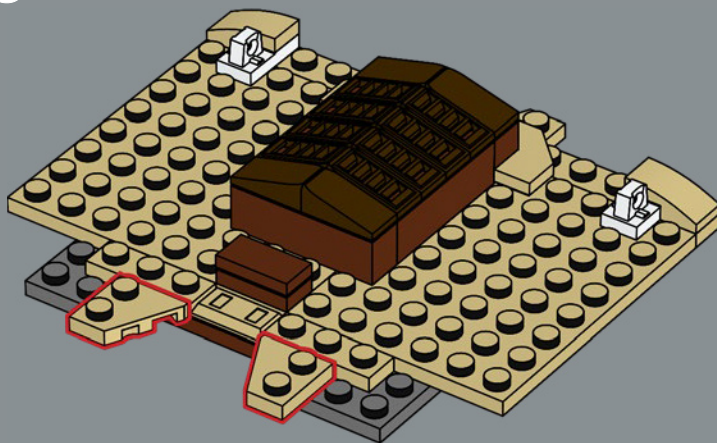

489

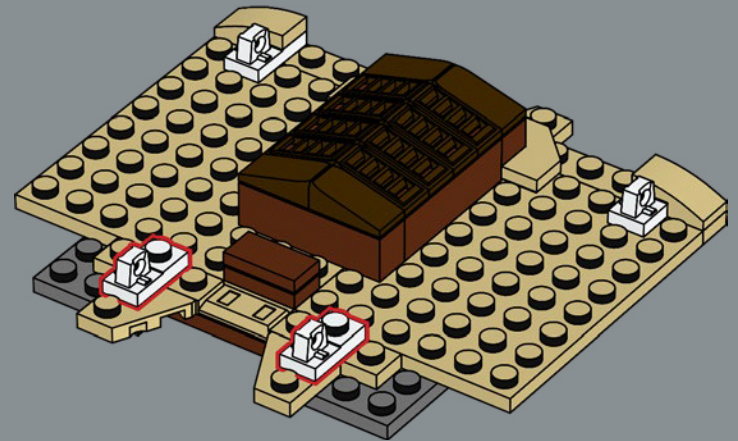

490

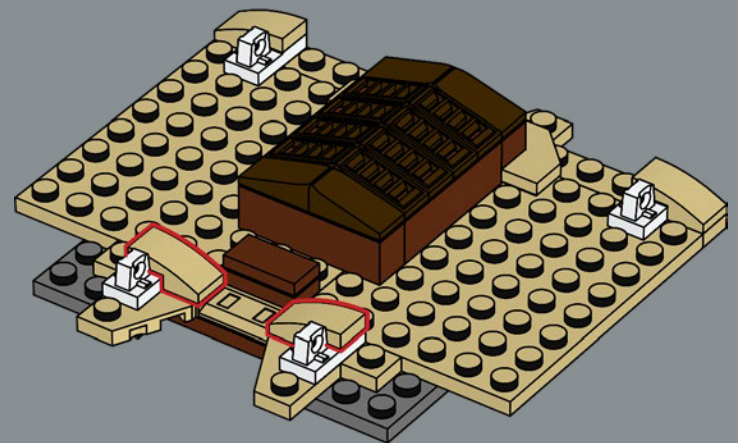



2x

491

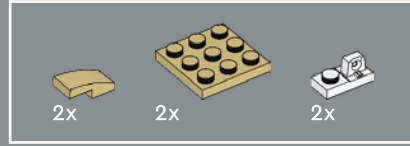
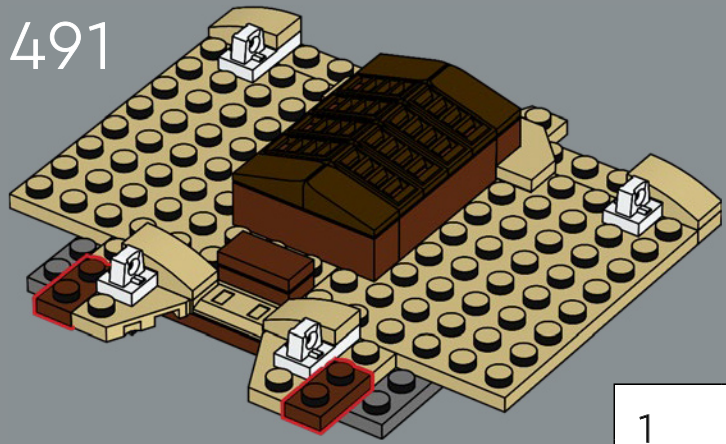

492

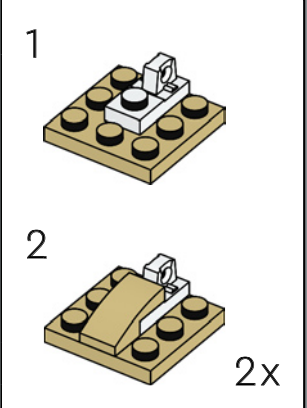
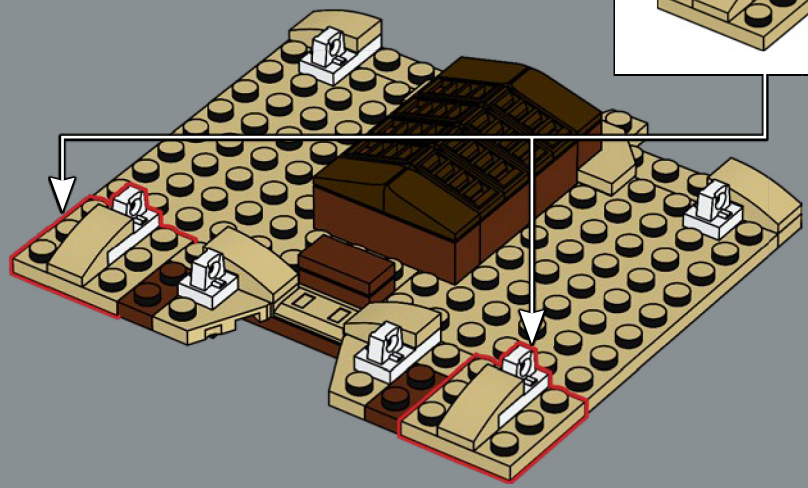

1

2

2x



4x

493

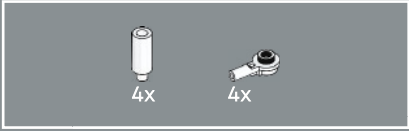
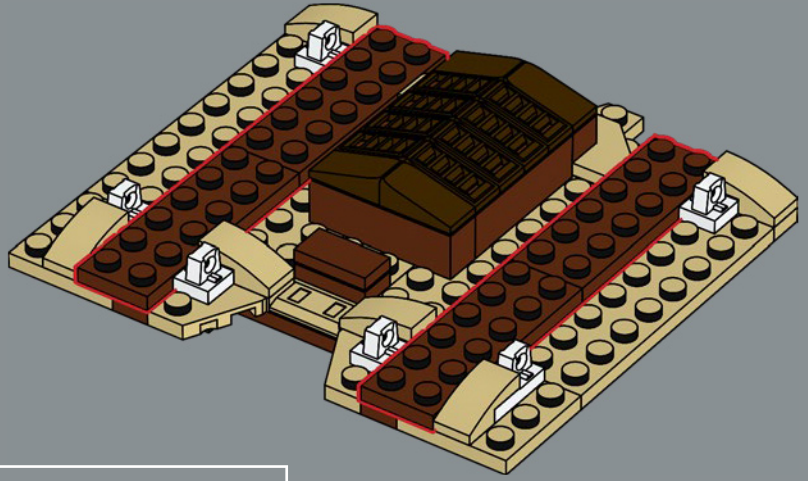

494

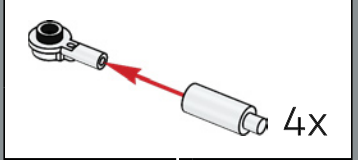
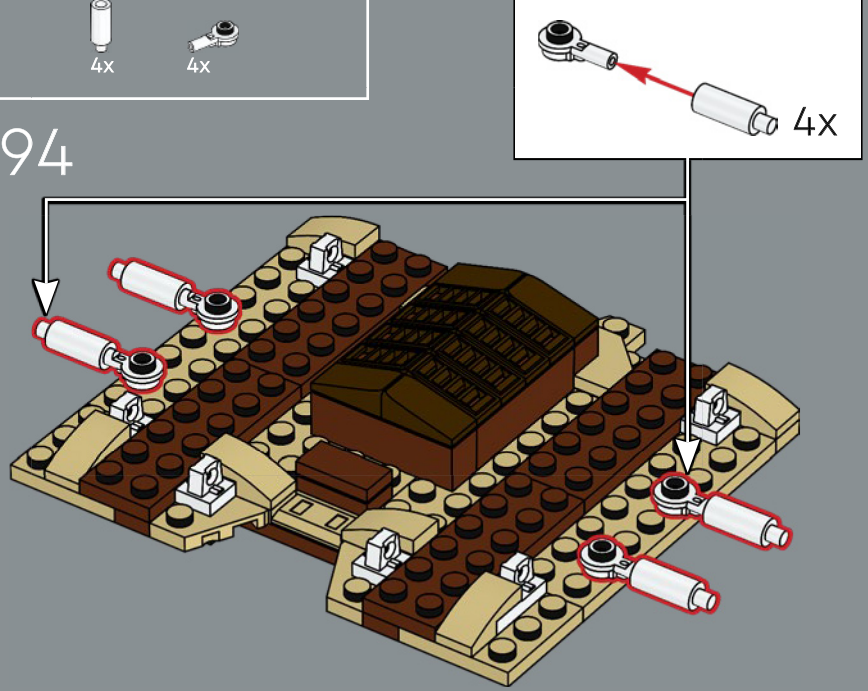

4x



495

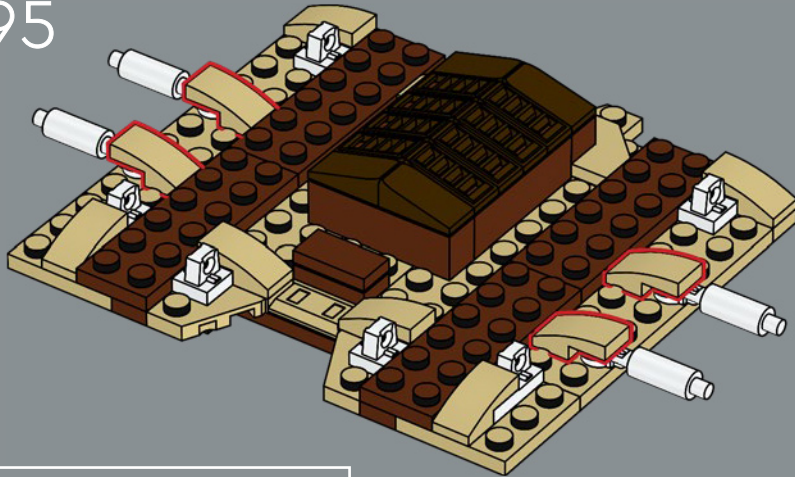

496

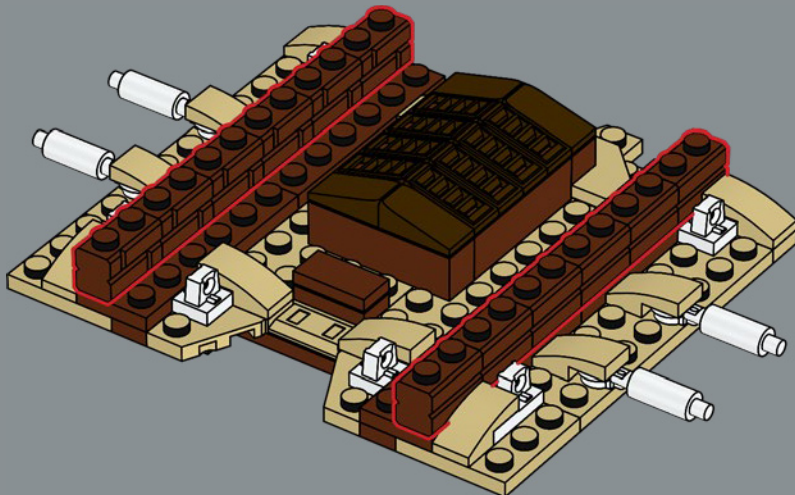

497

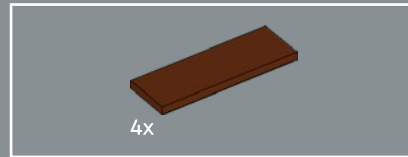
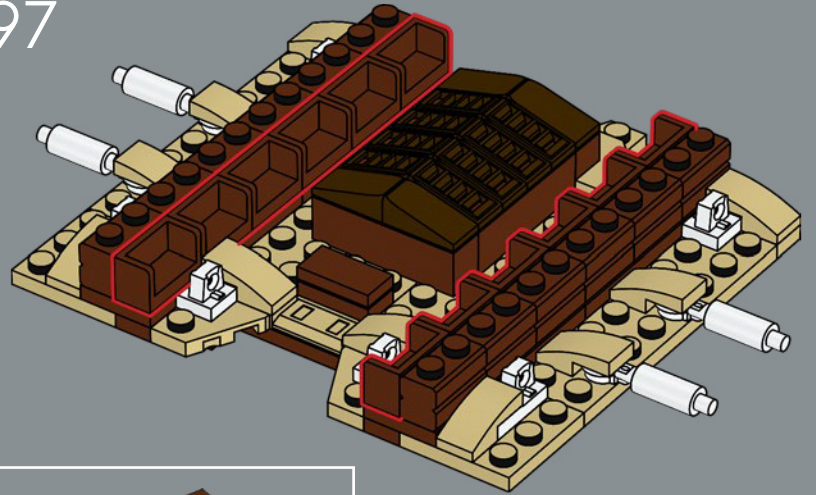

498

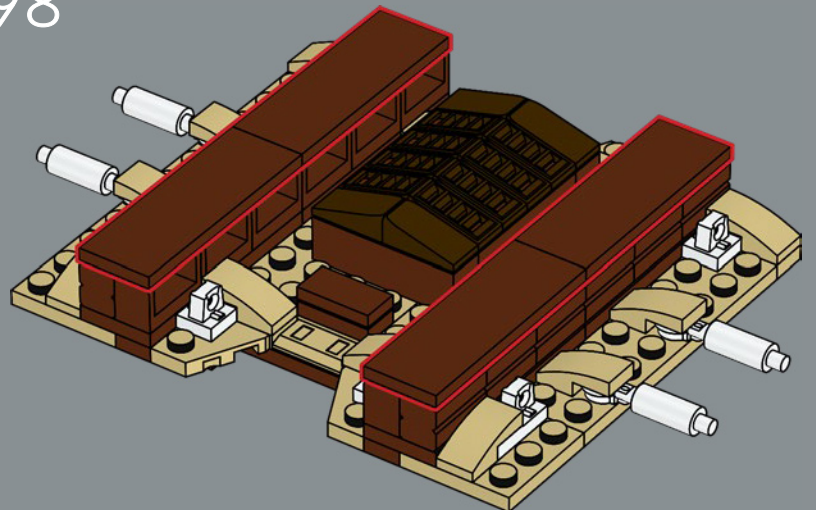

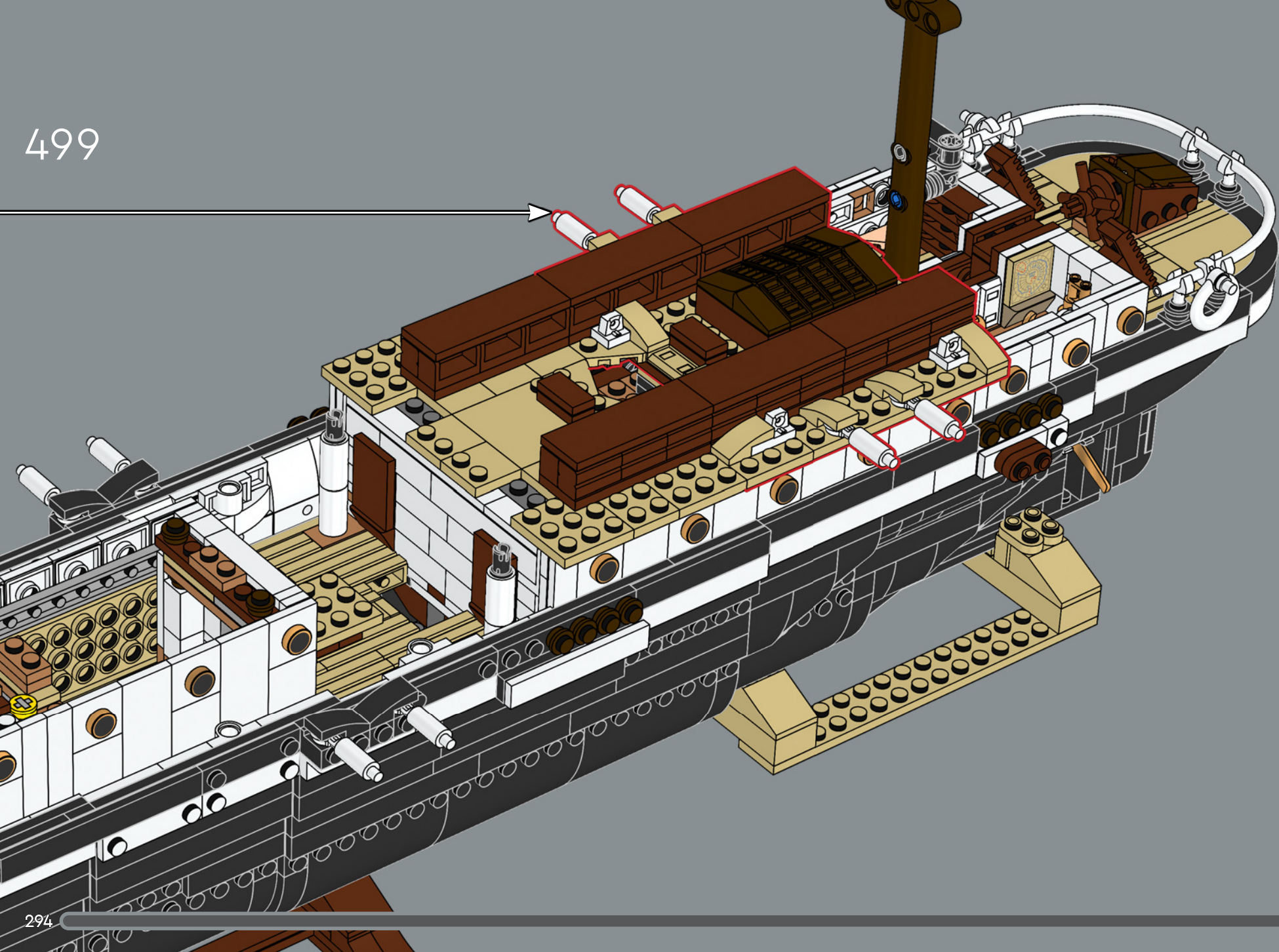

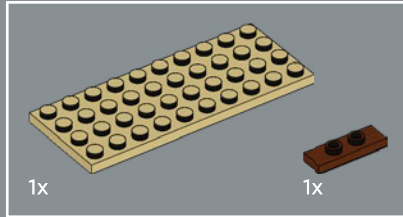
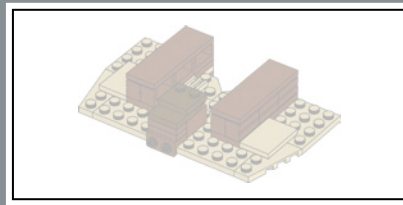

500

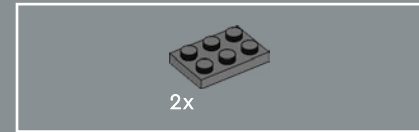
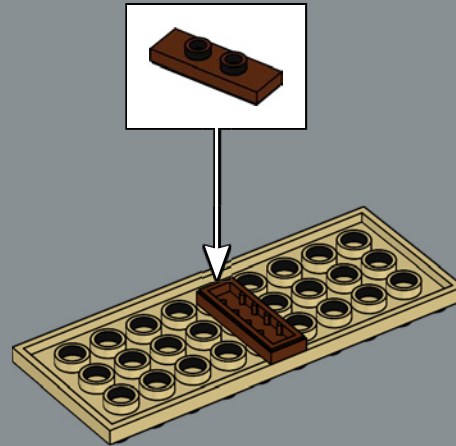

501

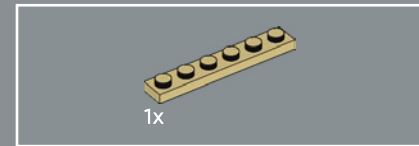
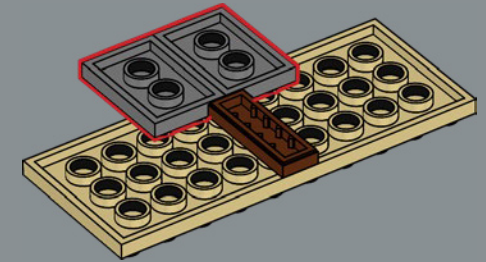

502

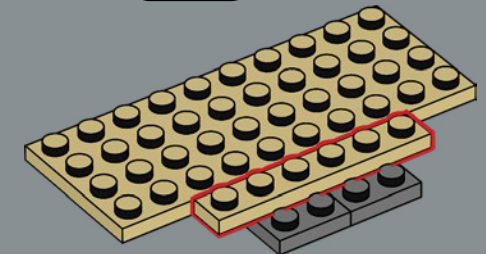

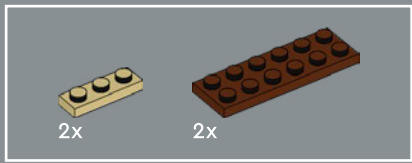

503

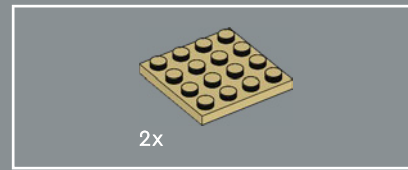
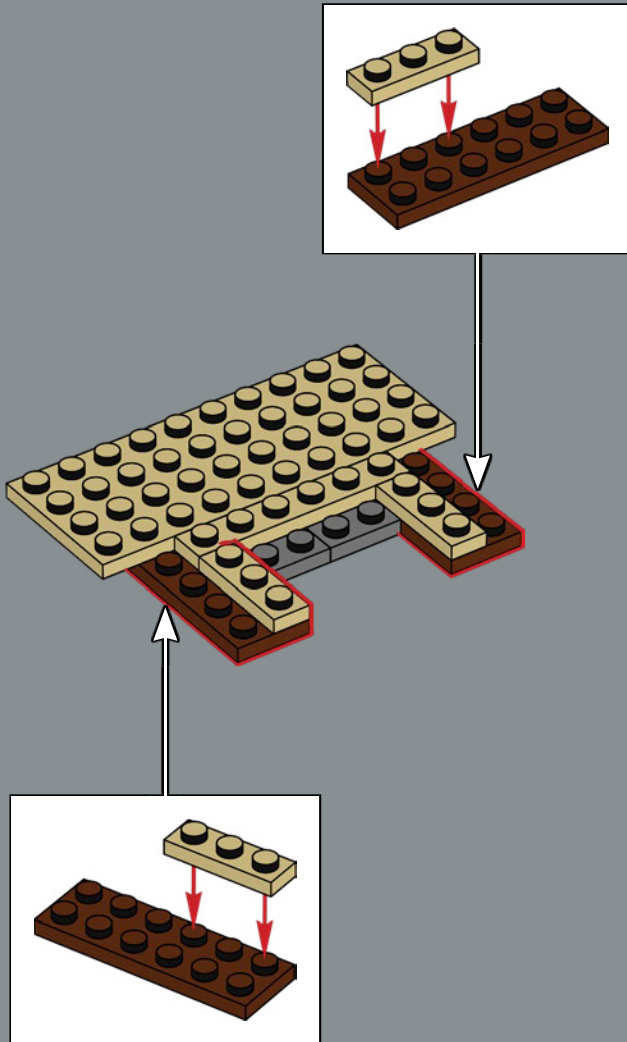

504

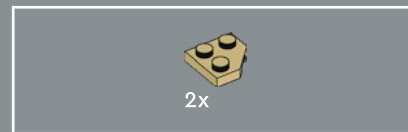
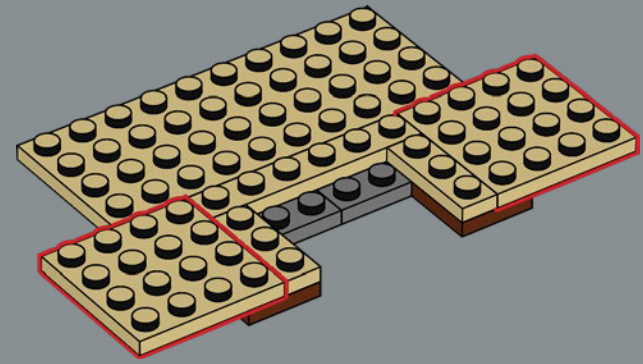

505

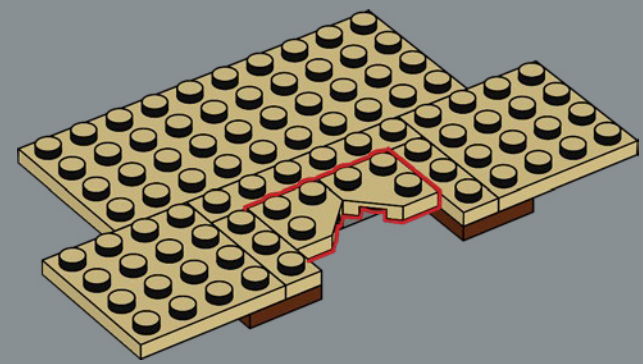

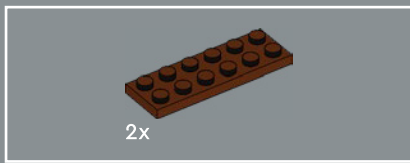

506

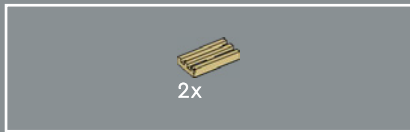
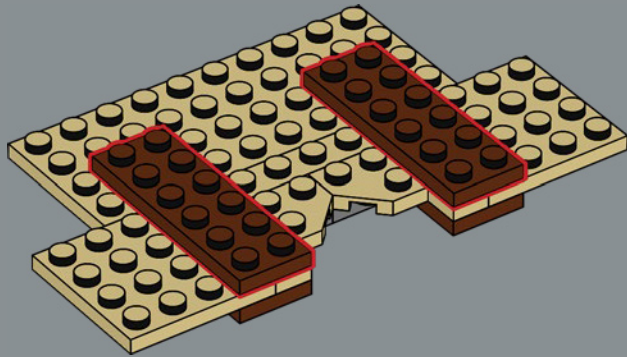

507

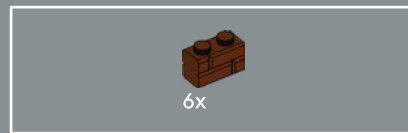
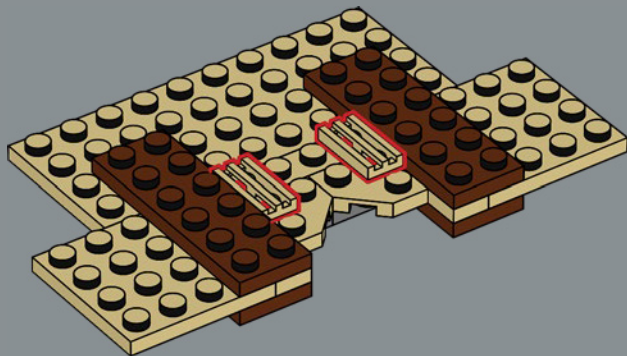

508

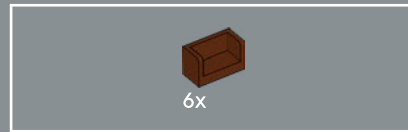
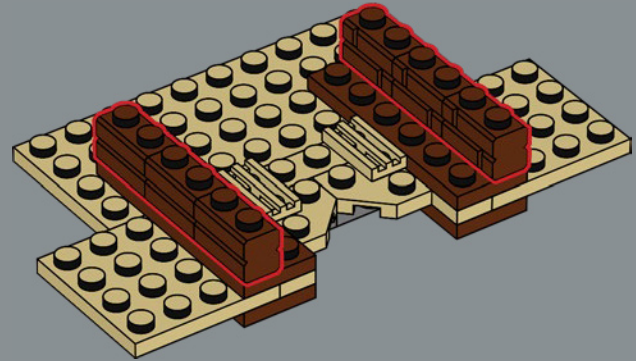

509

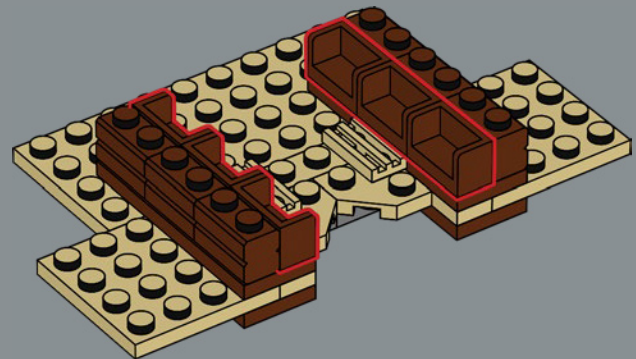

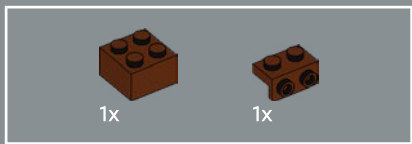

510

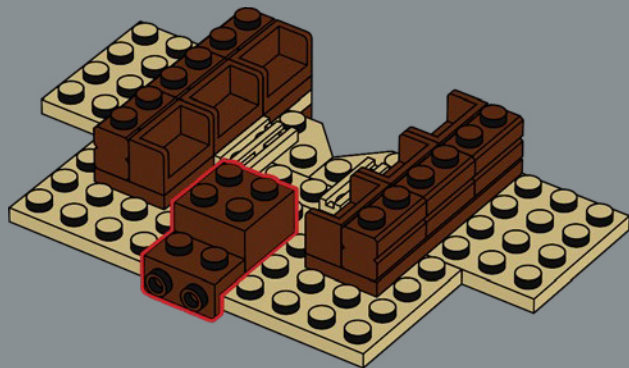

511

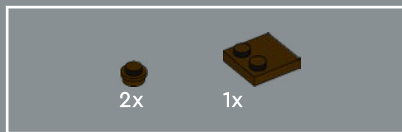
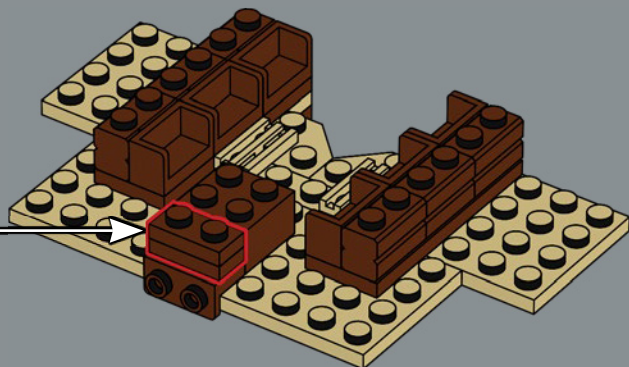
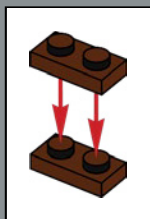

512

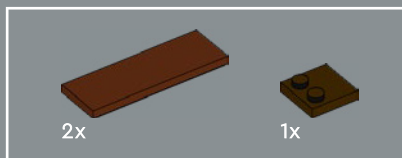
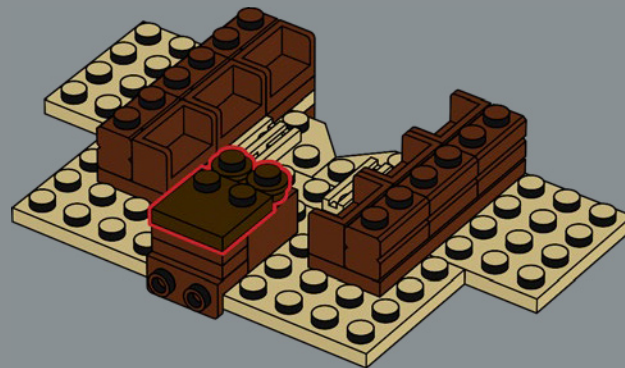

513

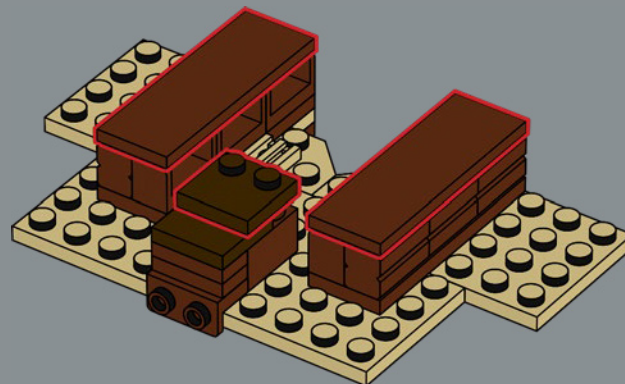

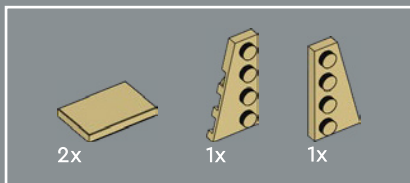

514

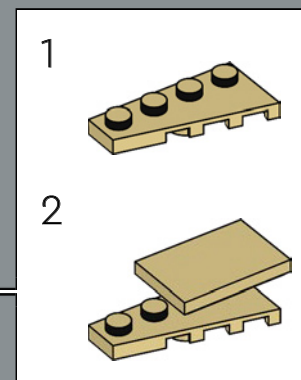
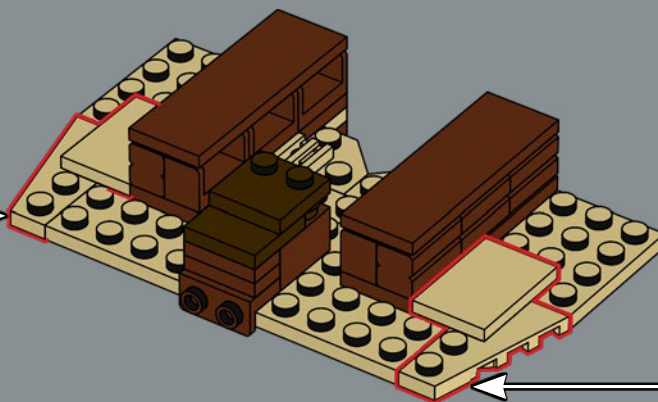
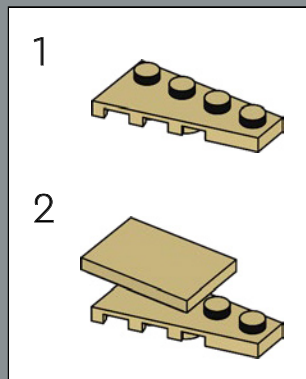

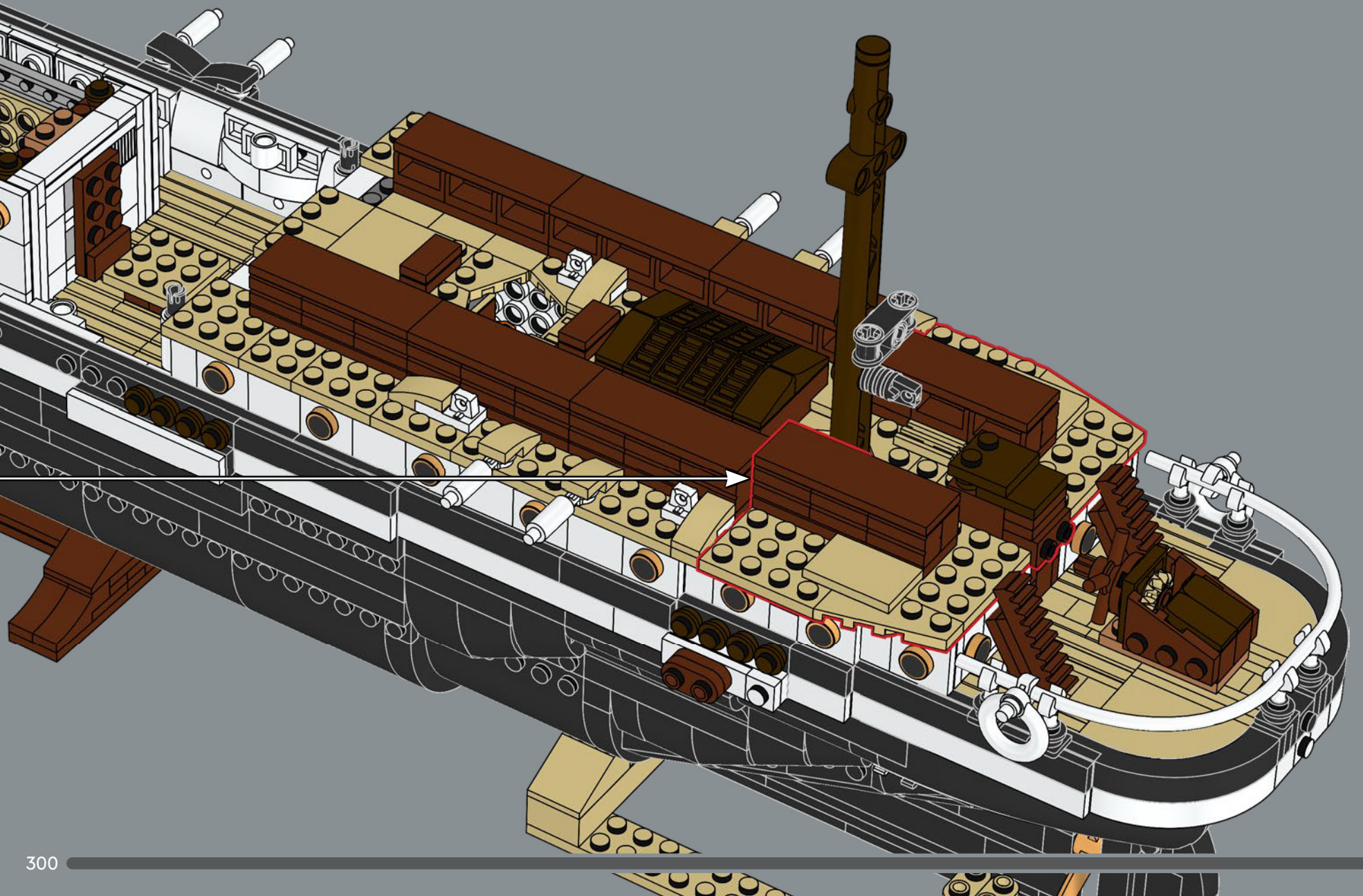

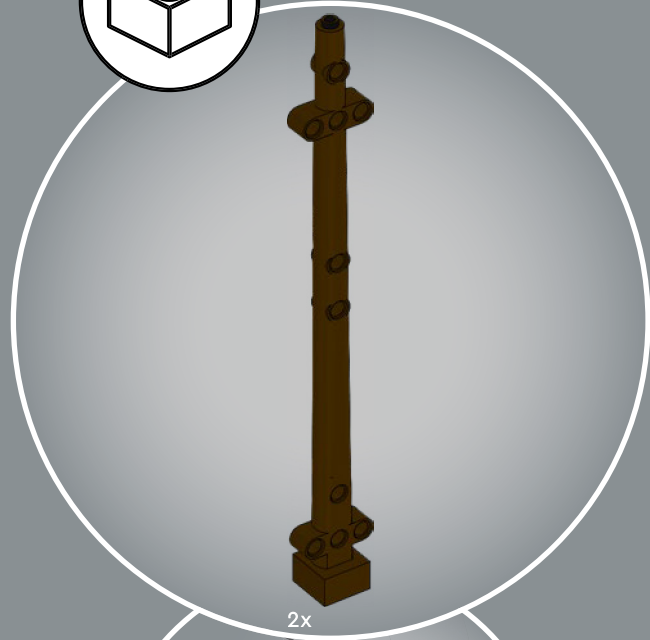
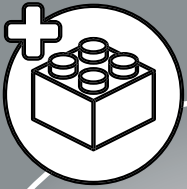

2x



23



4x

516

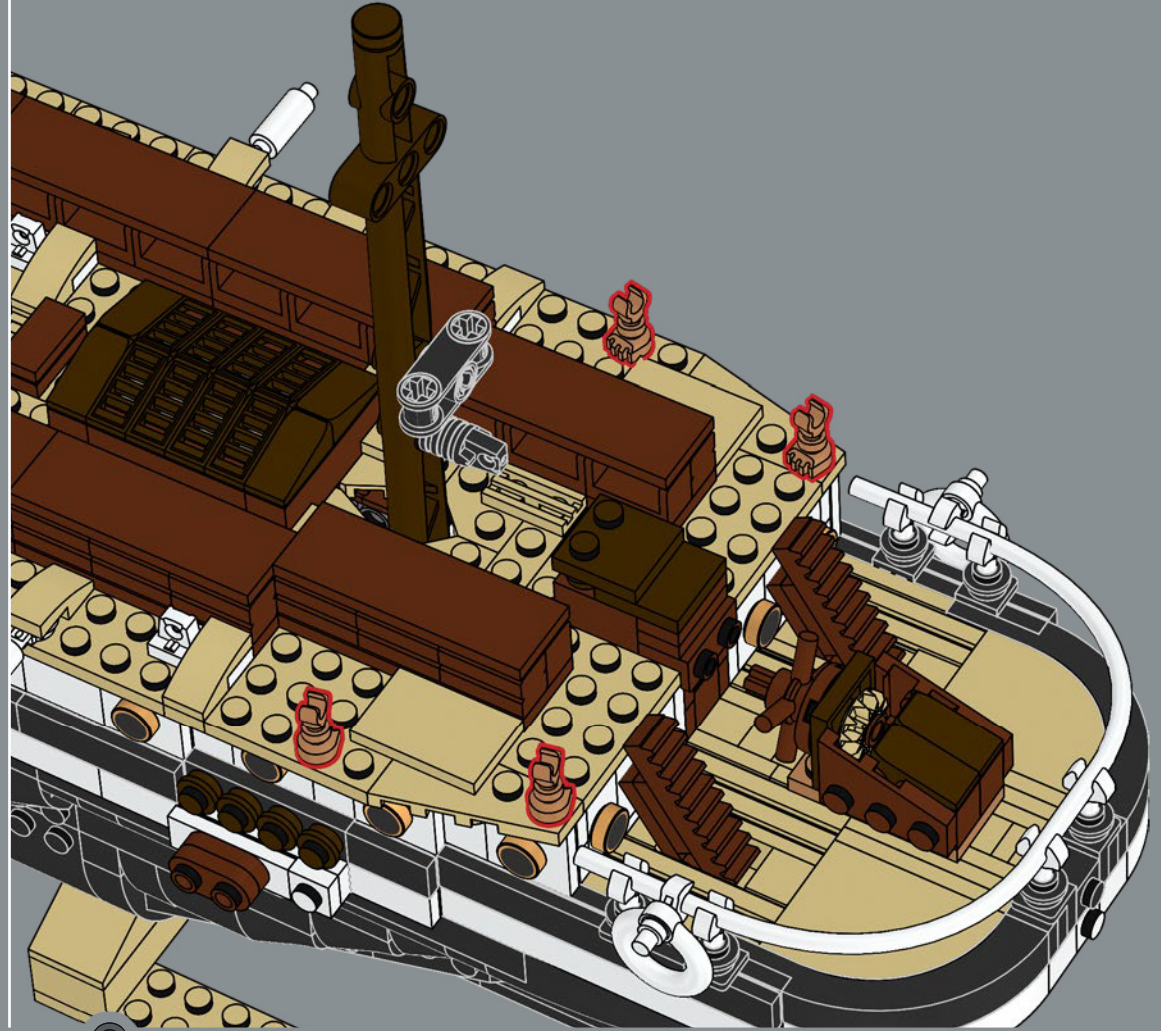



517

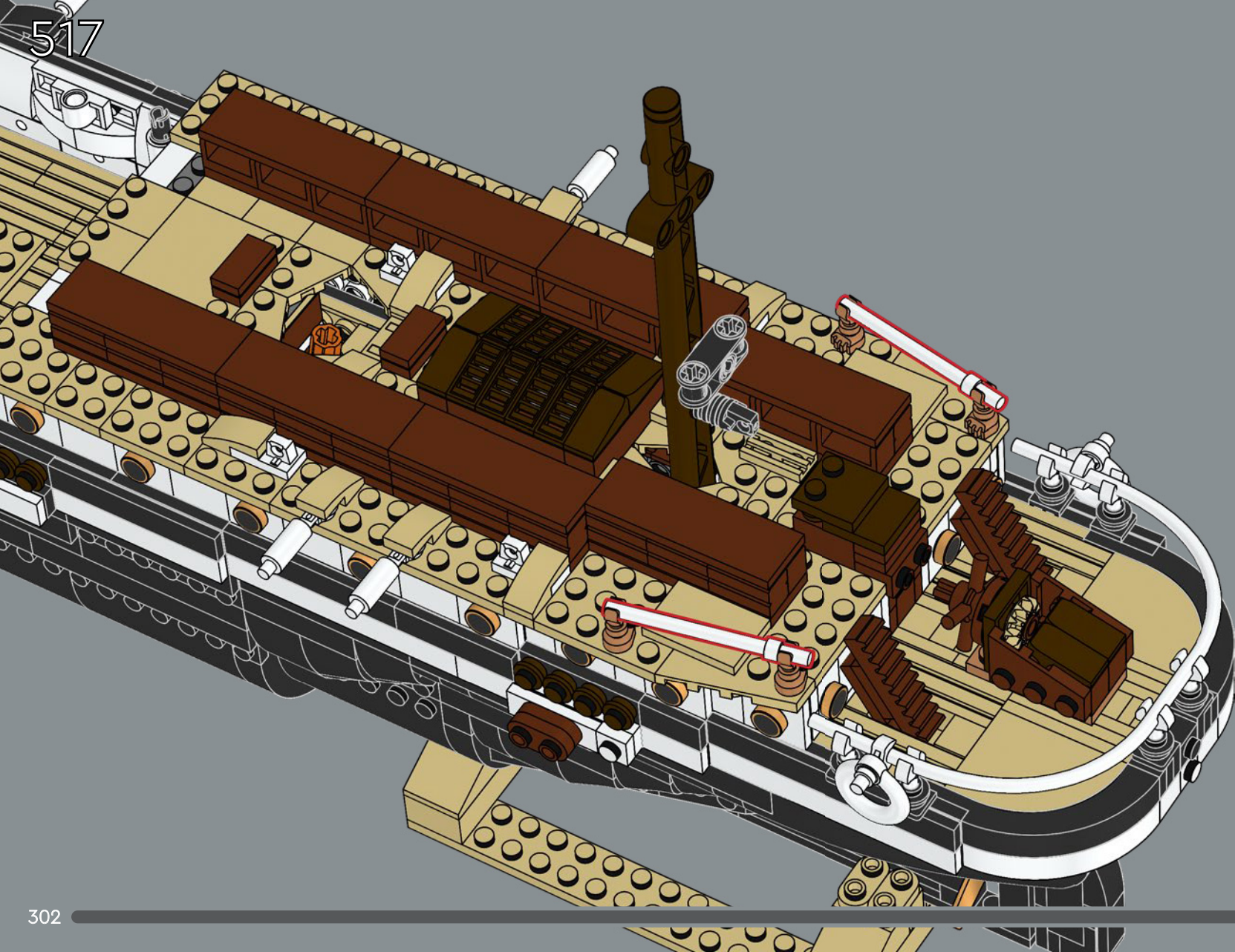

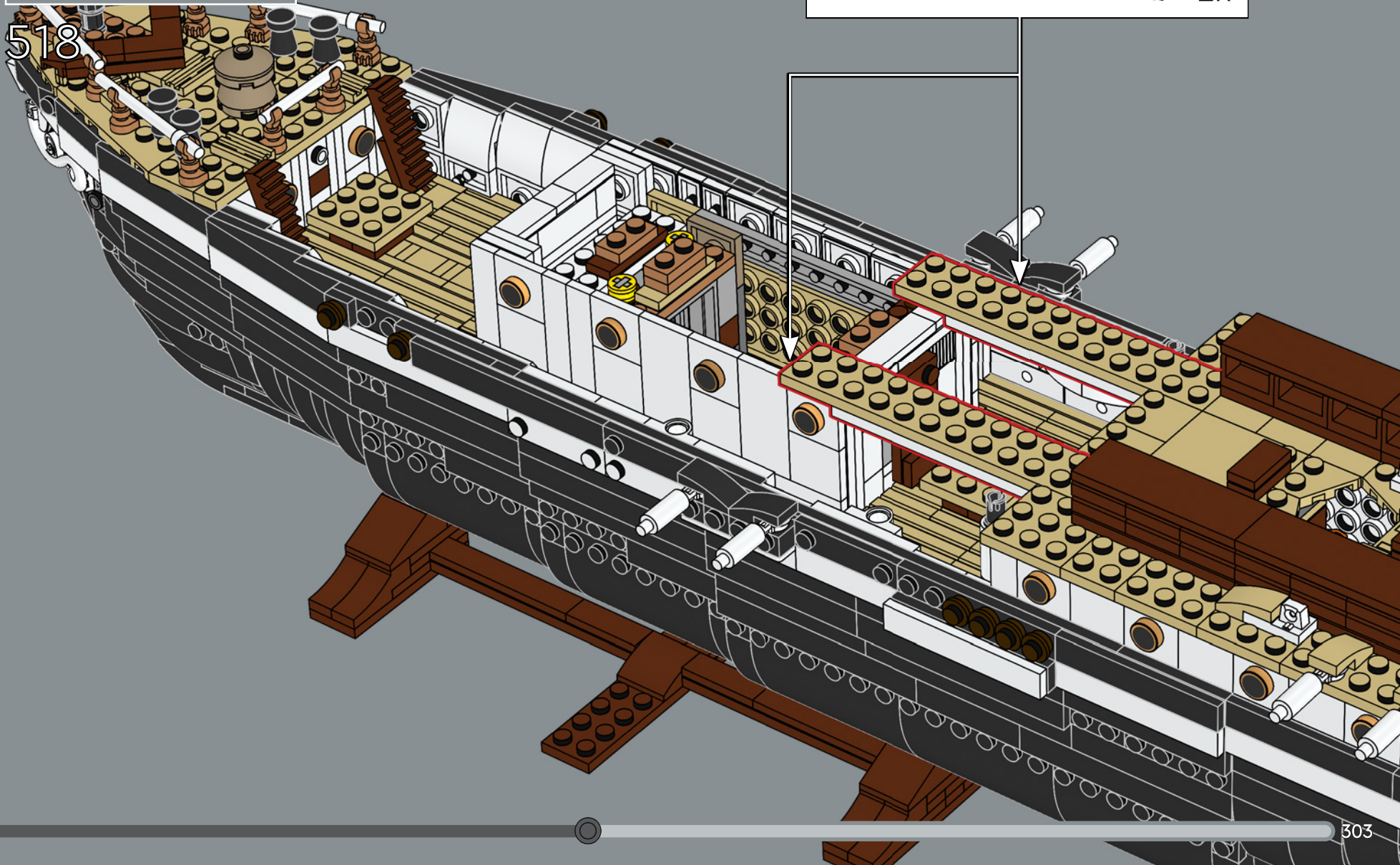
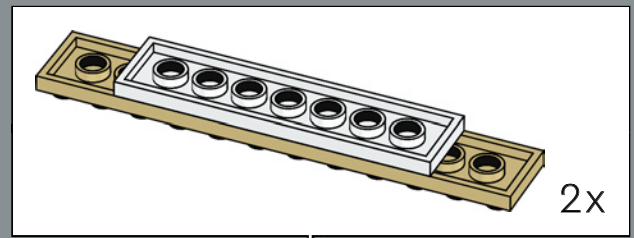
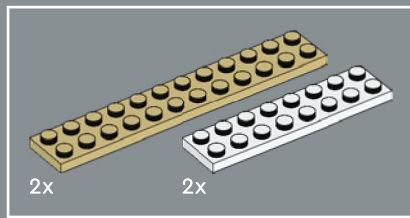

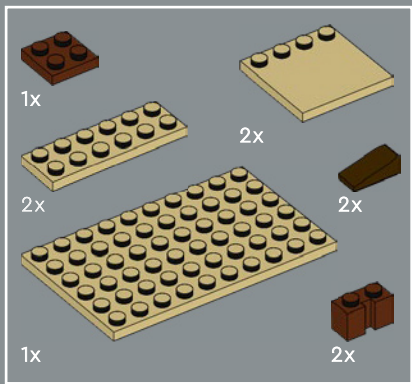

519

1

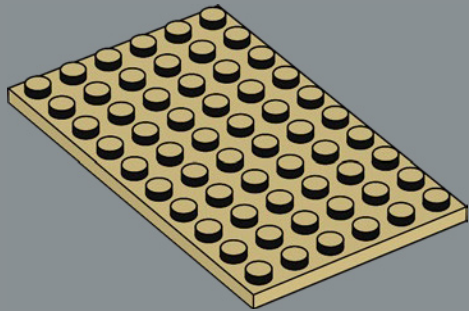

2

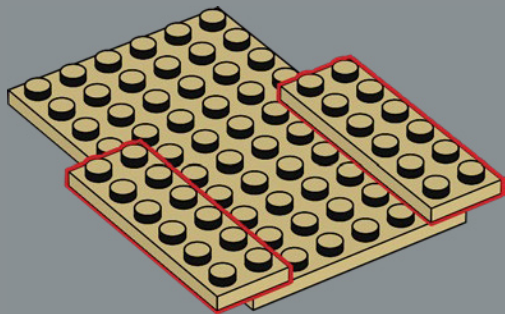

3

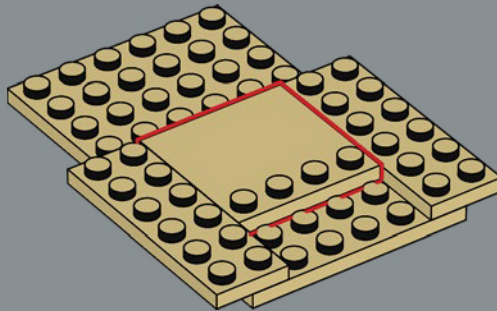

4

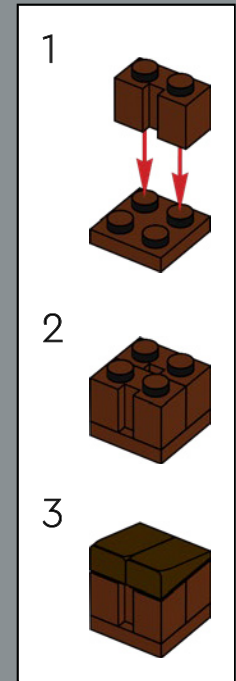
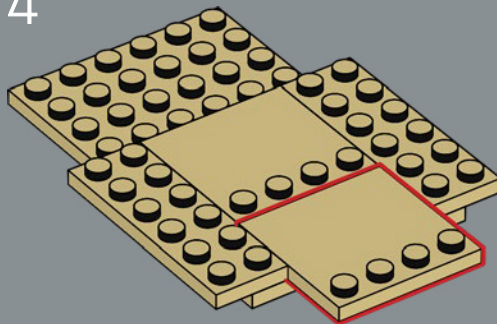

5

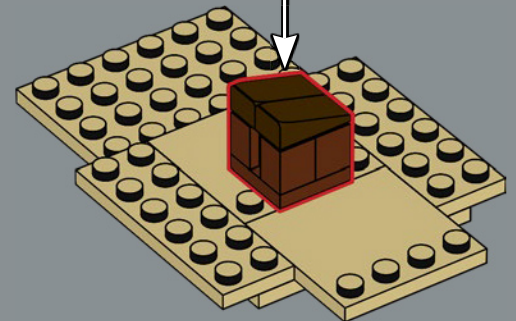

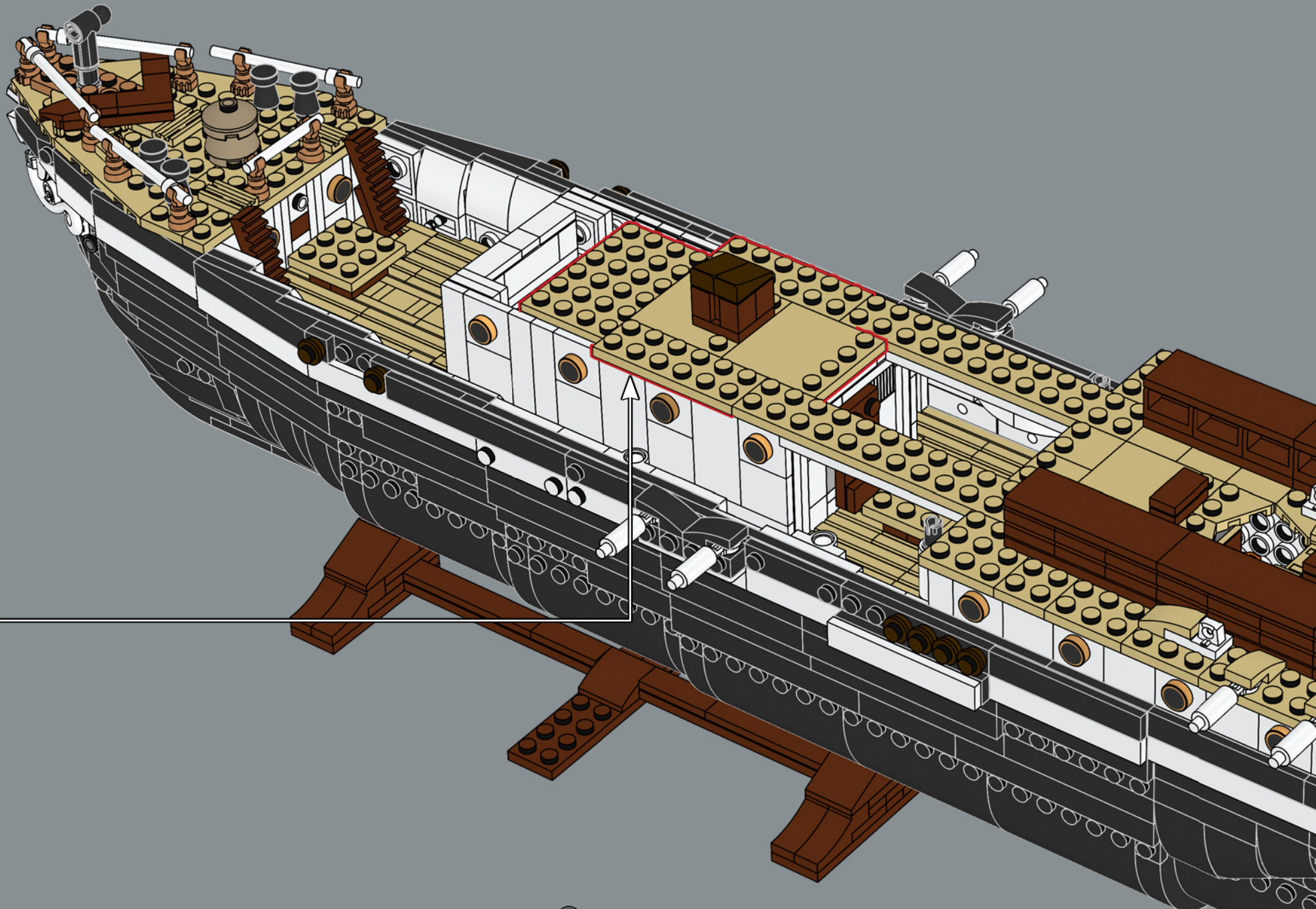

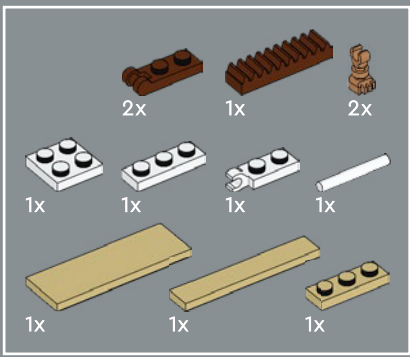

520

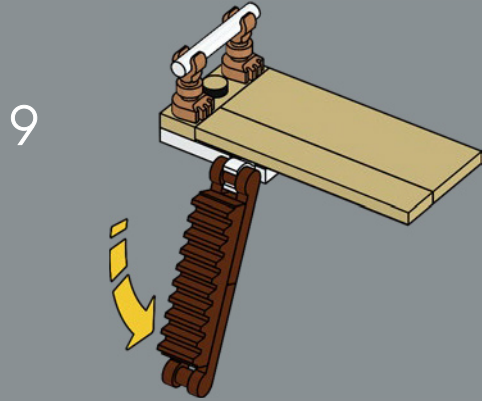
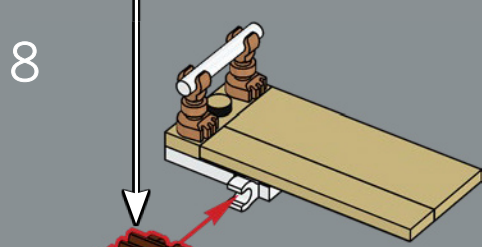
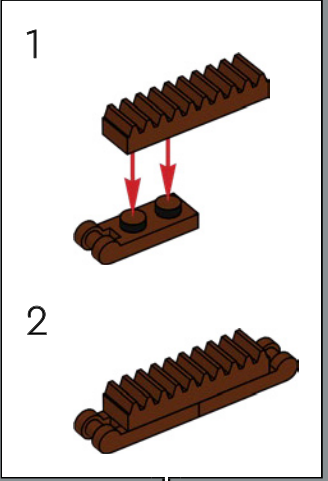
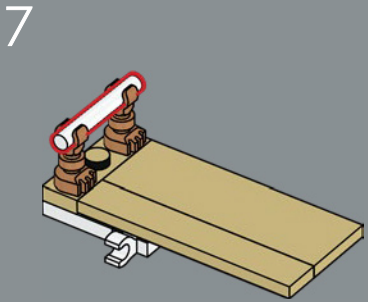
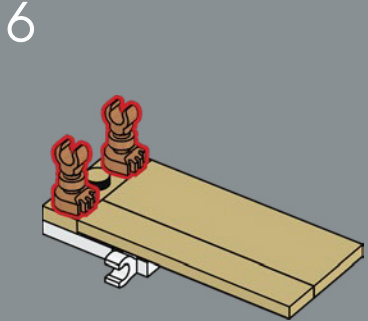
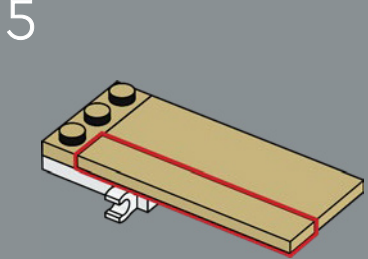
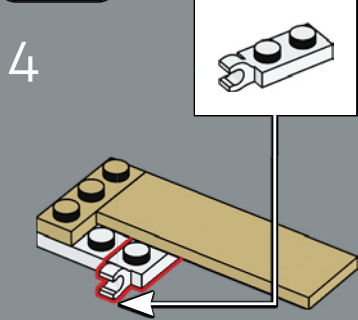
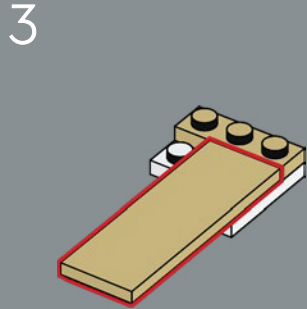
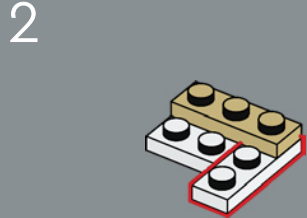
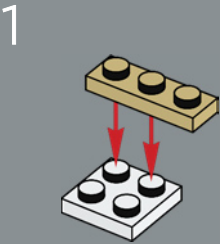

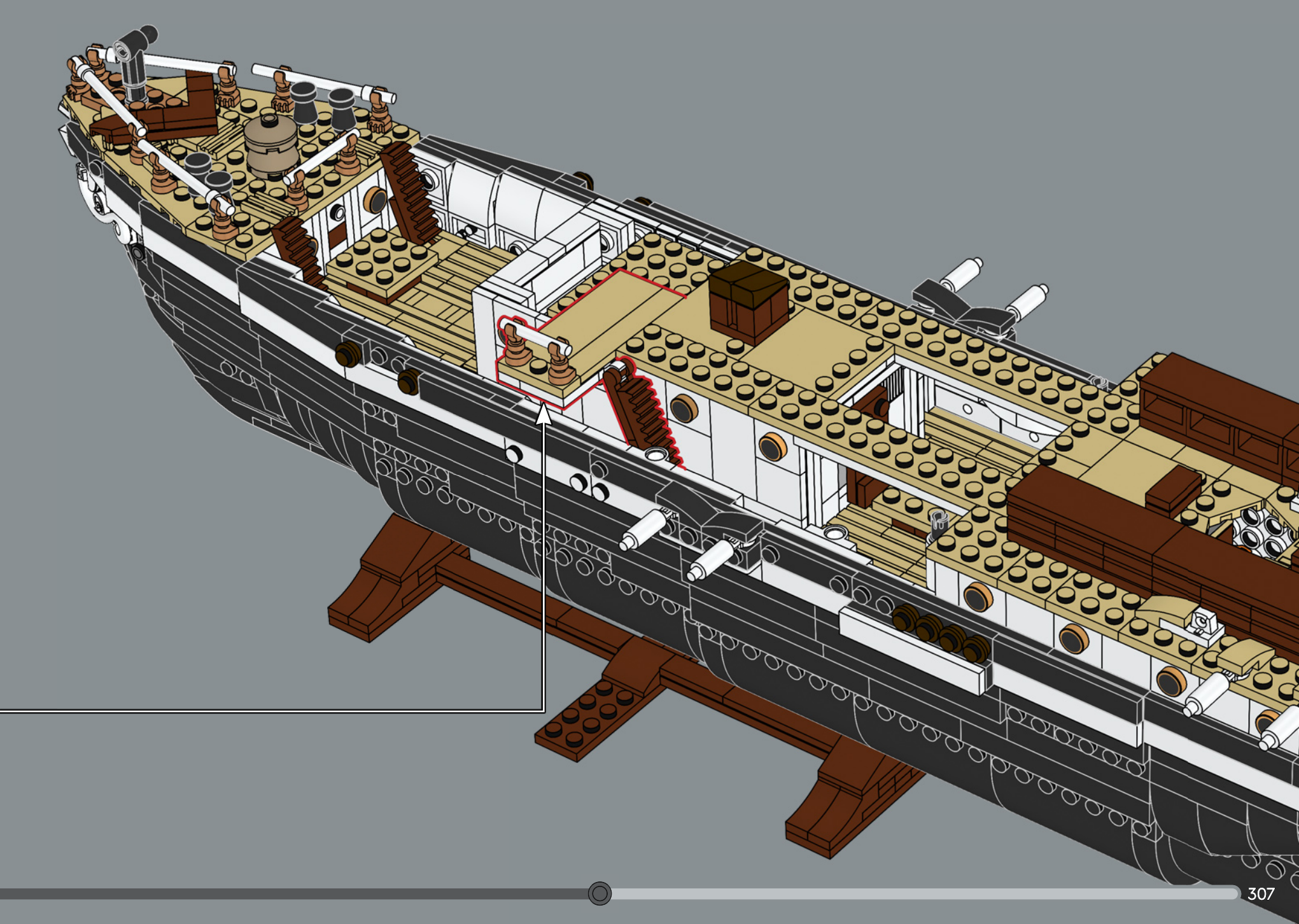

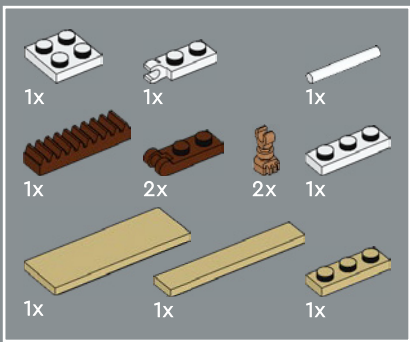

521

1

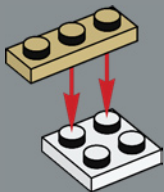

2

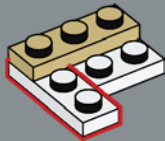

3

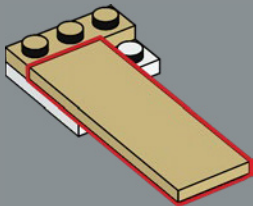

4

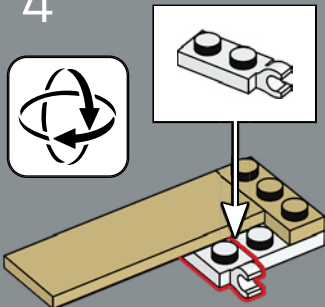

5

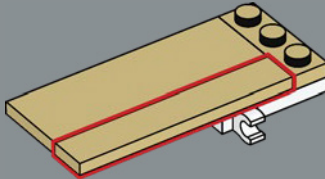

6

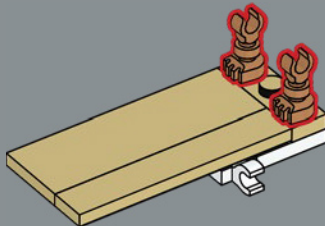

7

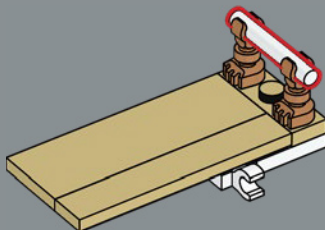

8

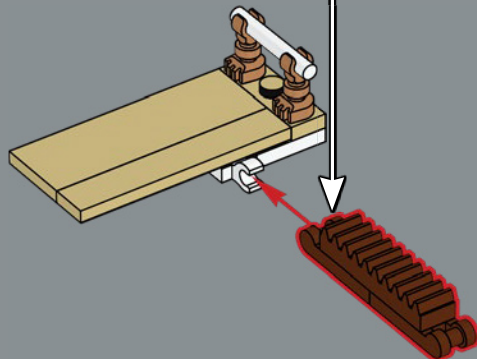

9

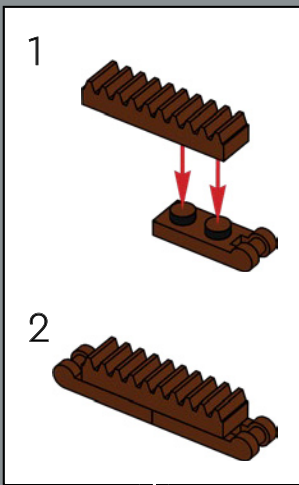
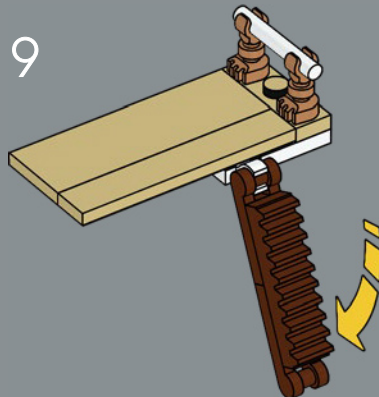

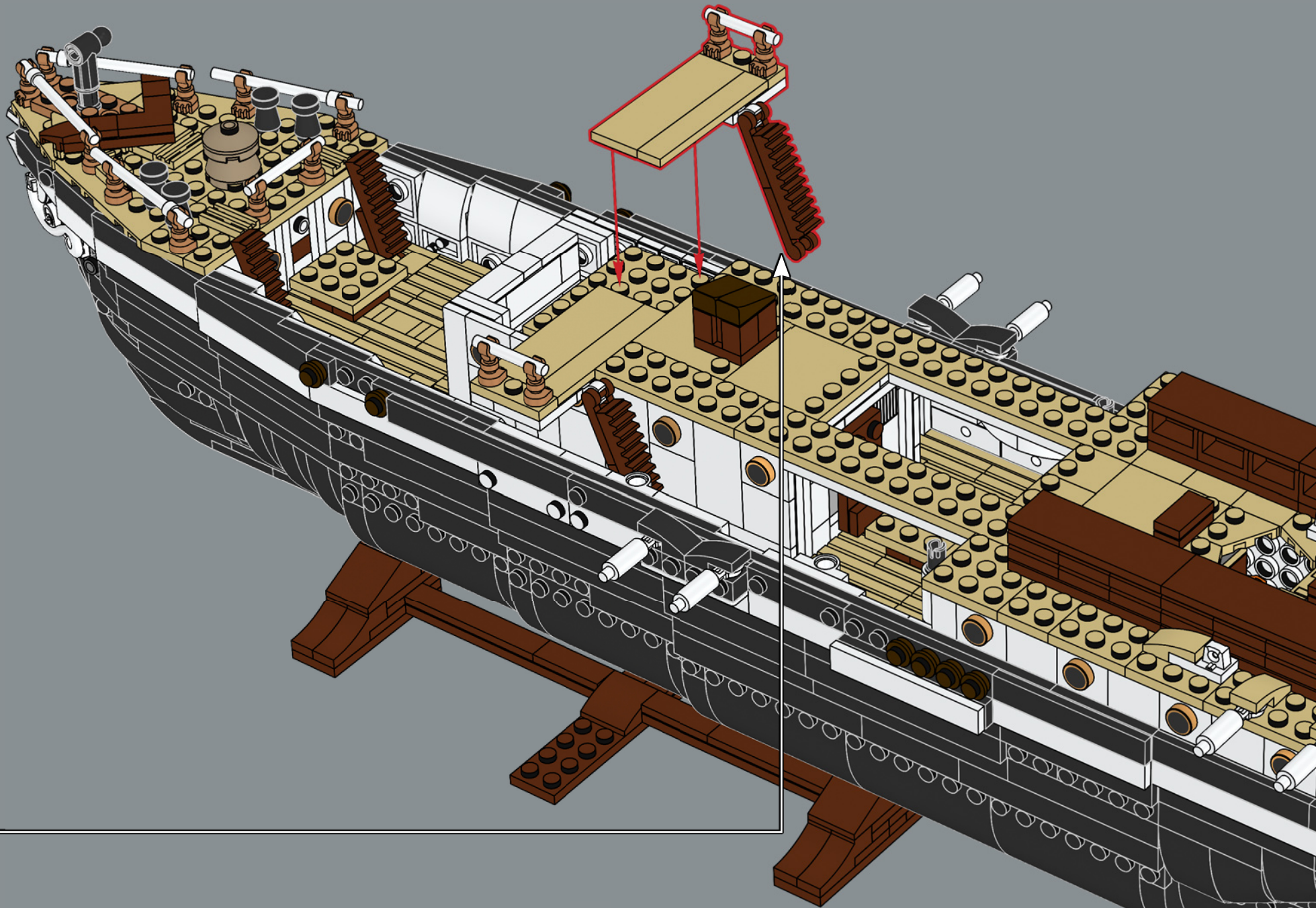

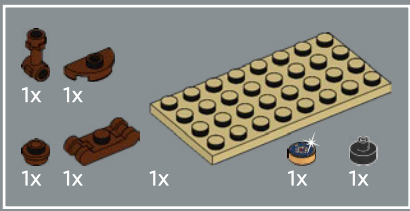

522

1

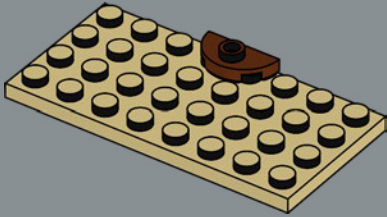

2

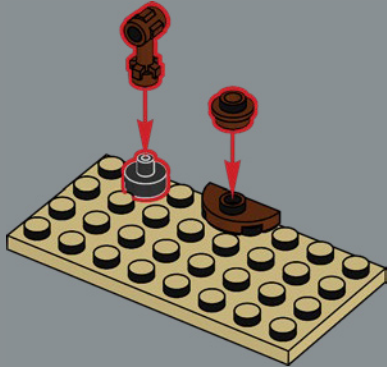

3

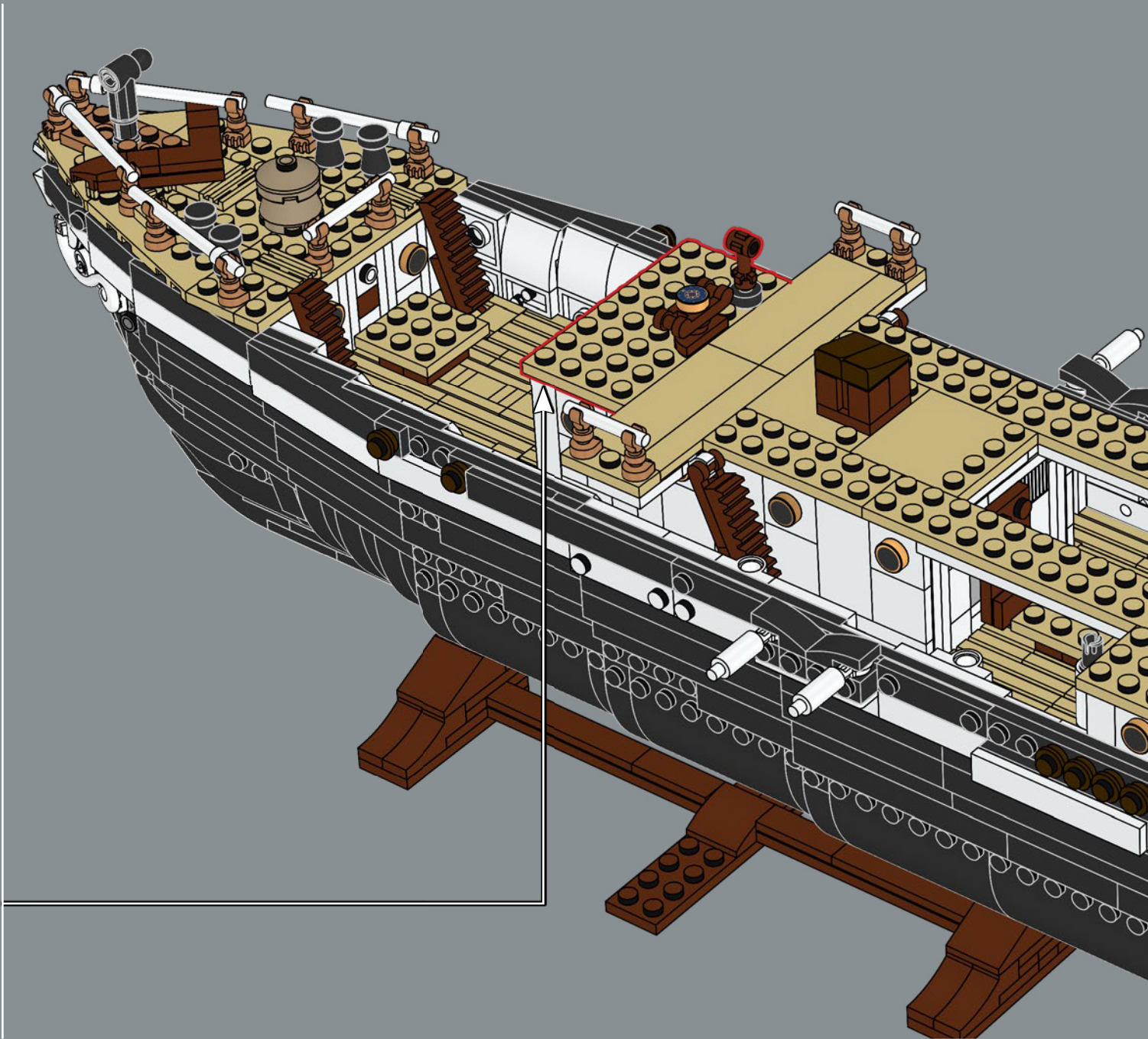

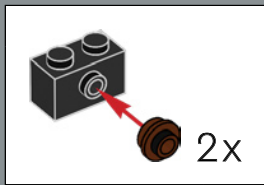

523

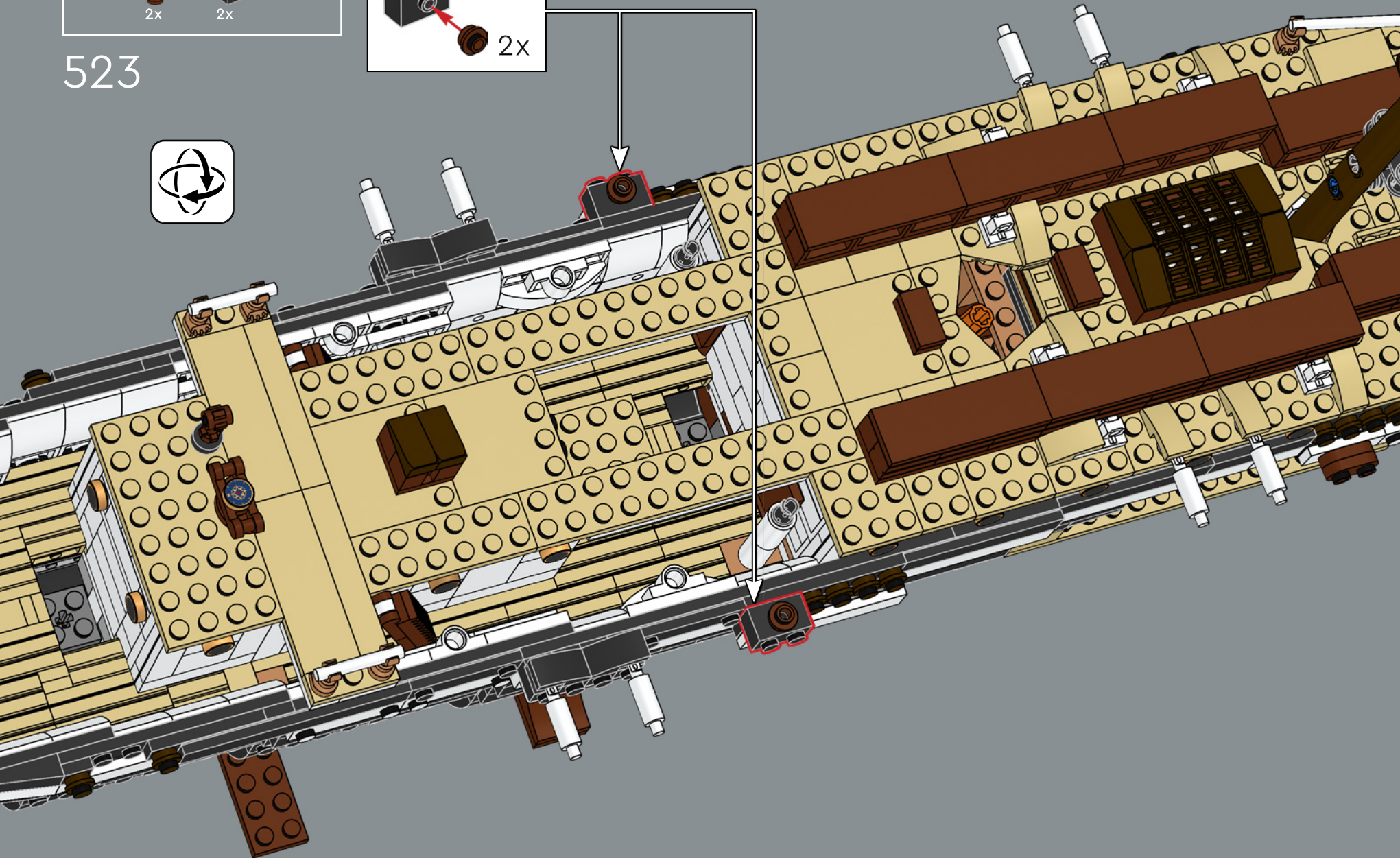



38x

524

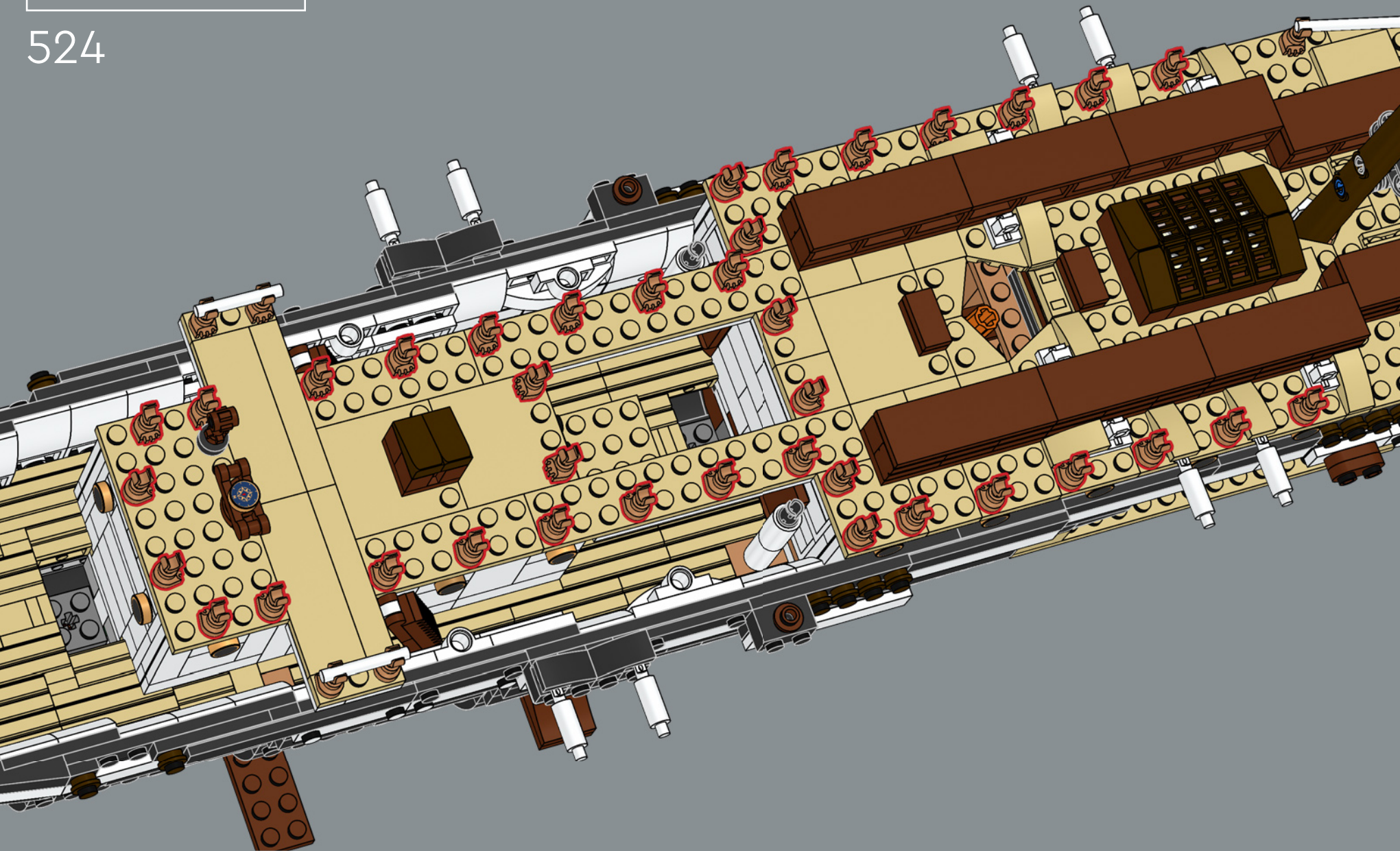

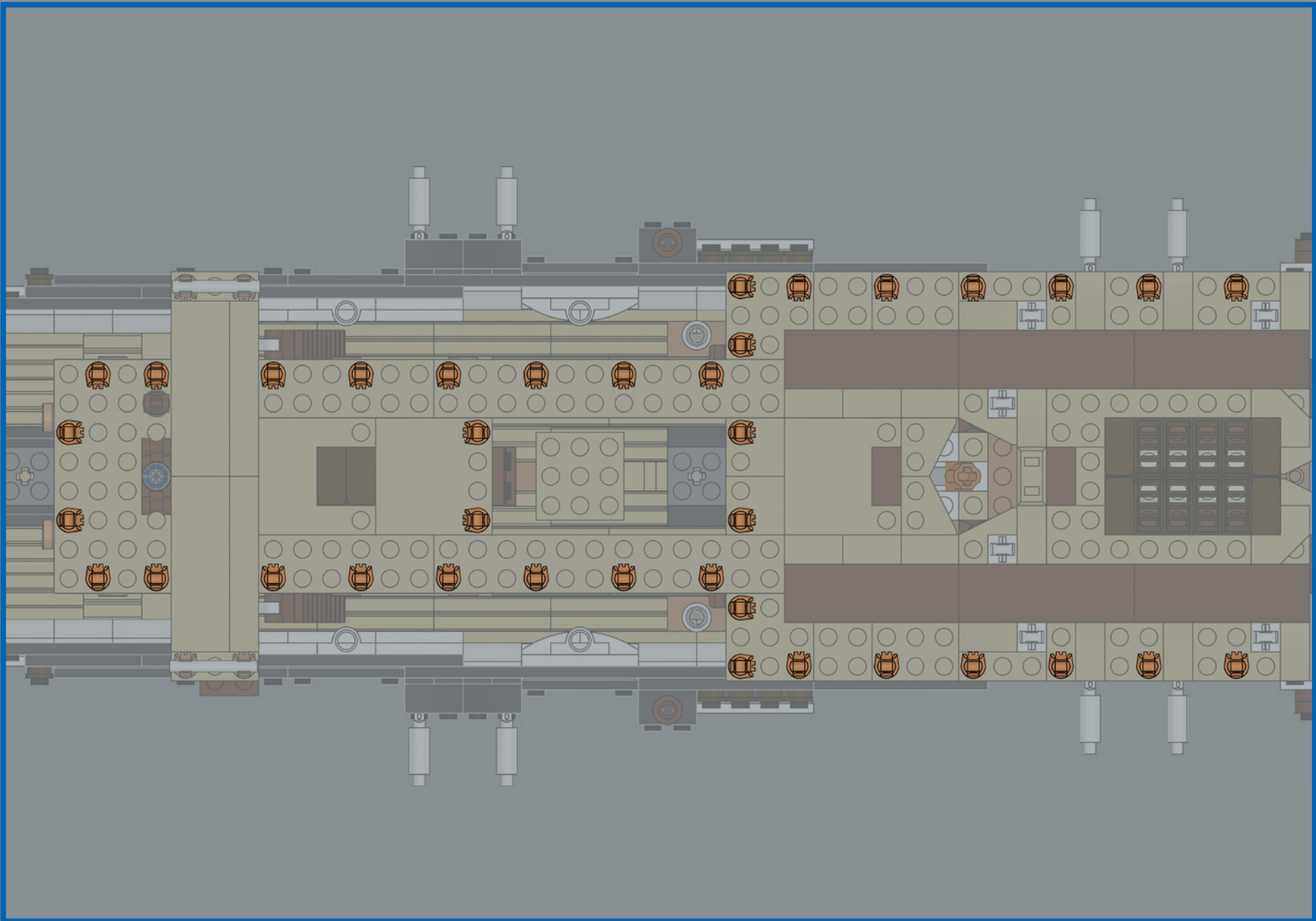

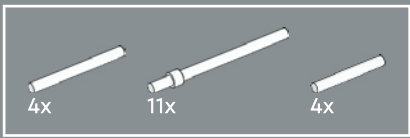

525

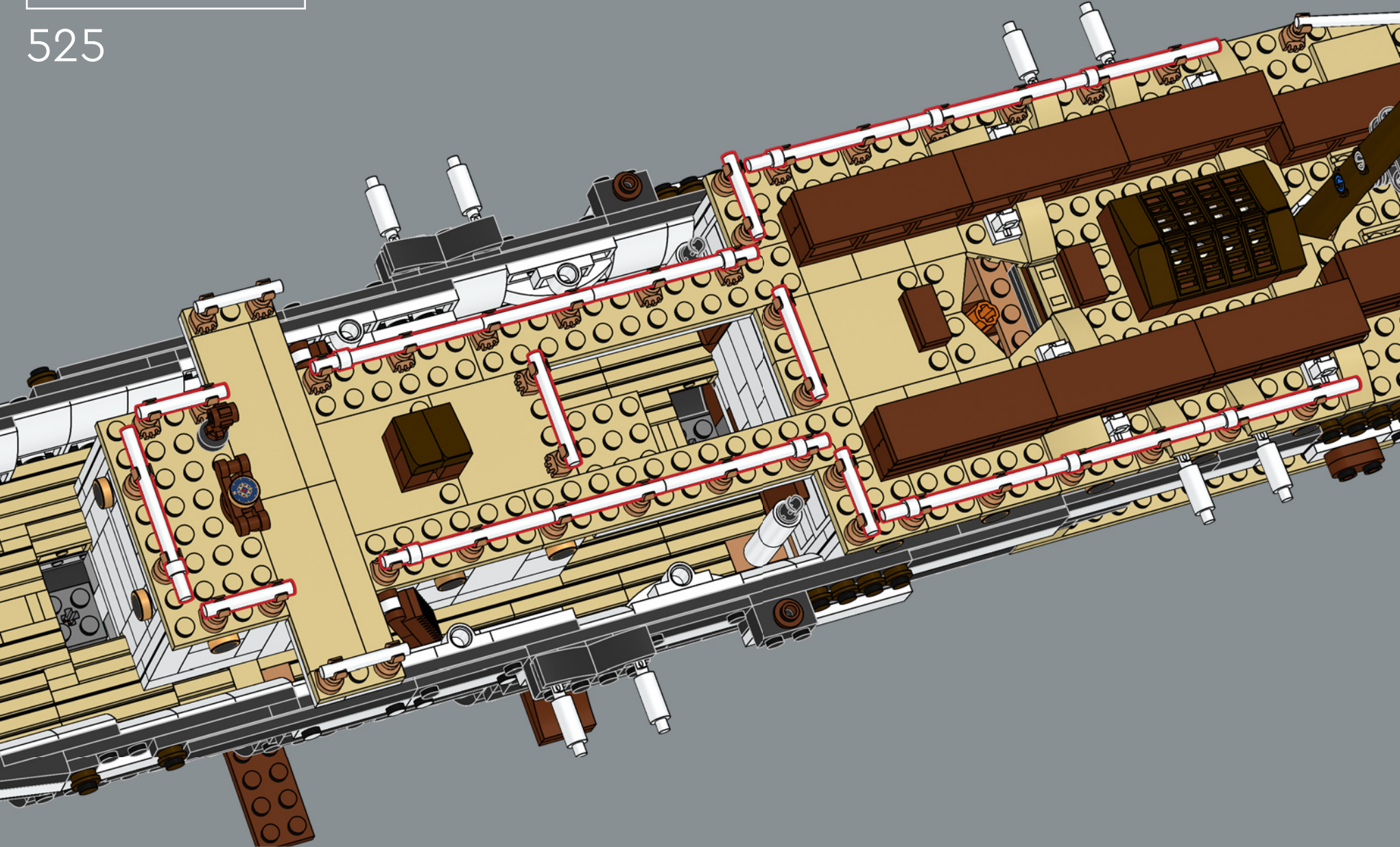

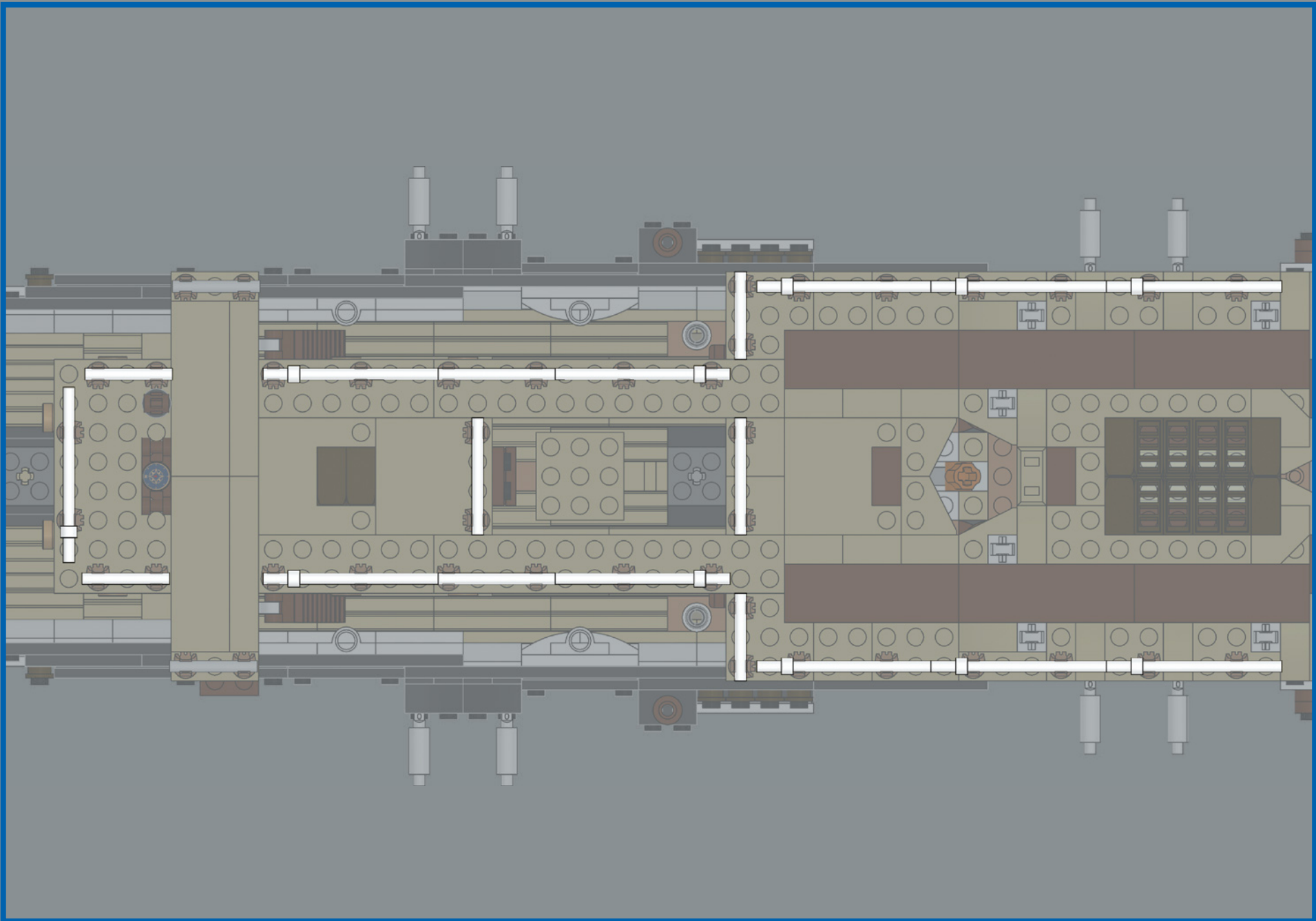

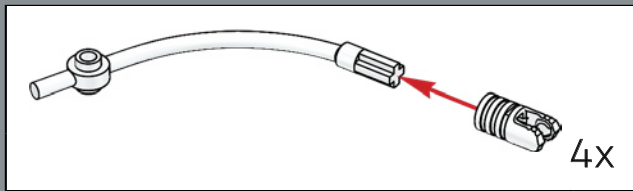
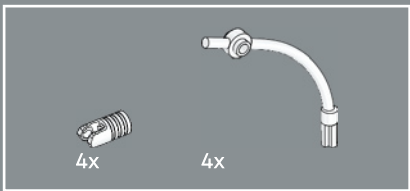

526

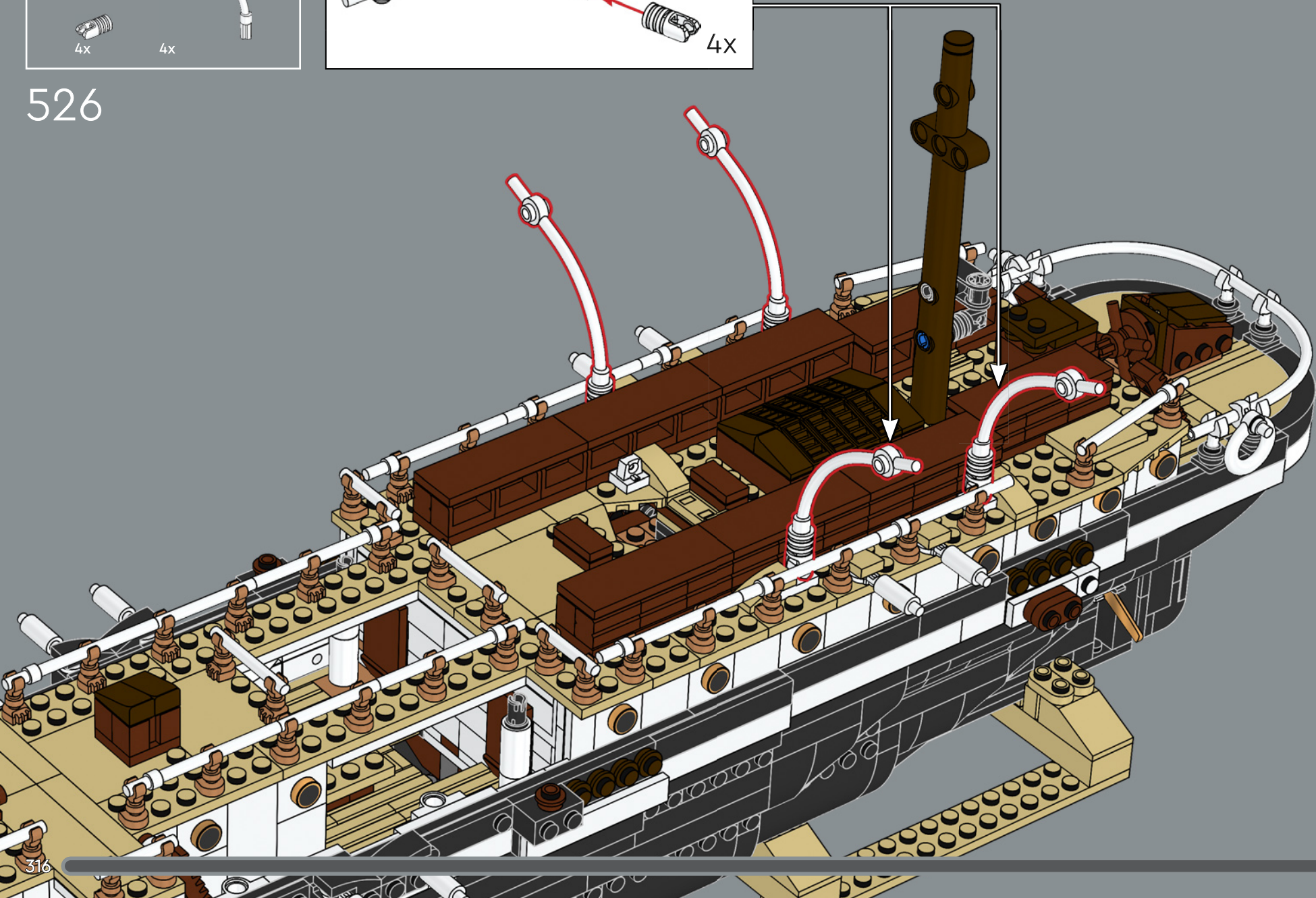

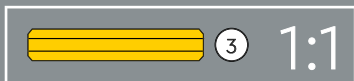
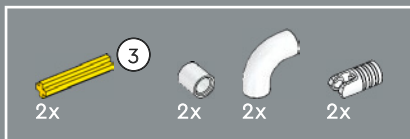

527

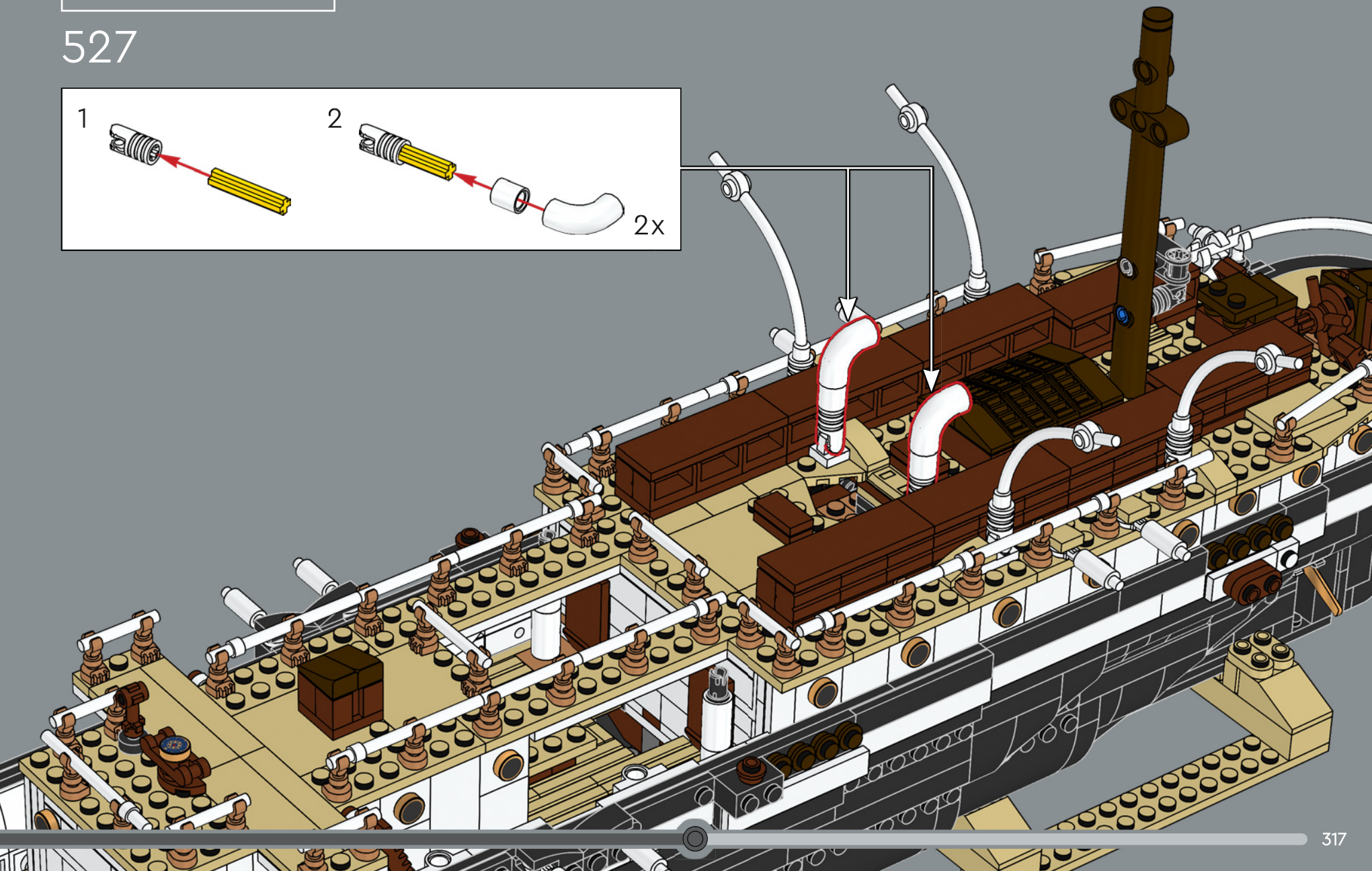
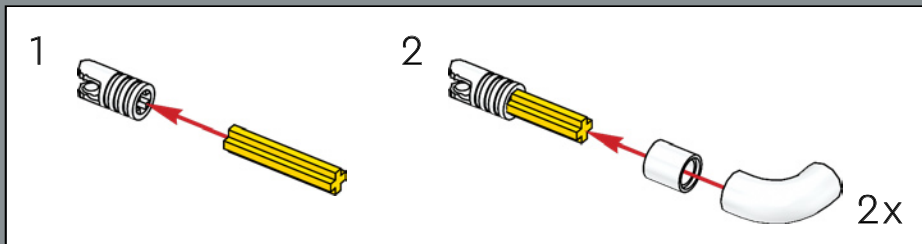

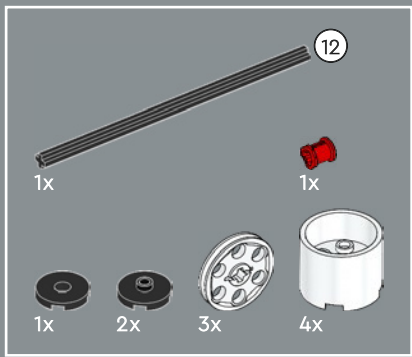

528

1

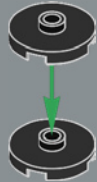

2

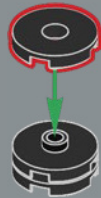

3



4

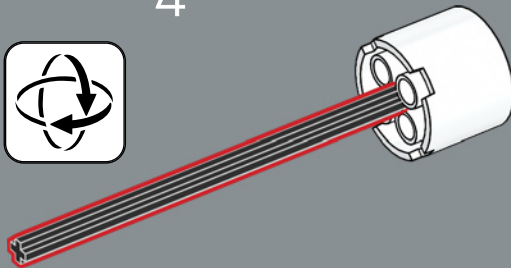

5



6

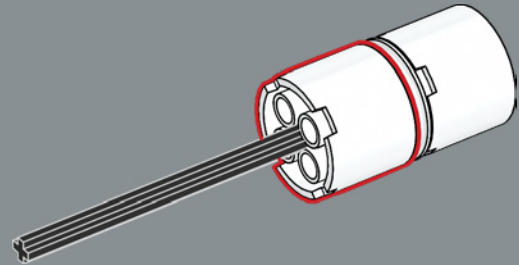

7

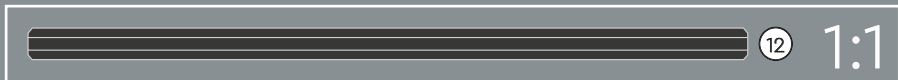
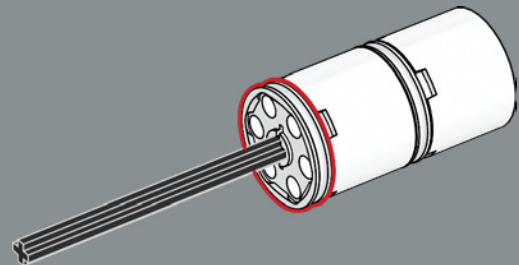

8

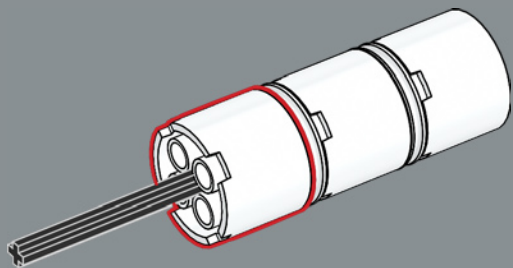

9

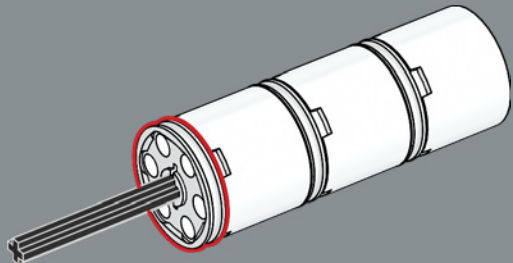

10

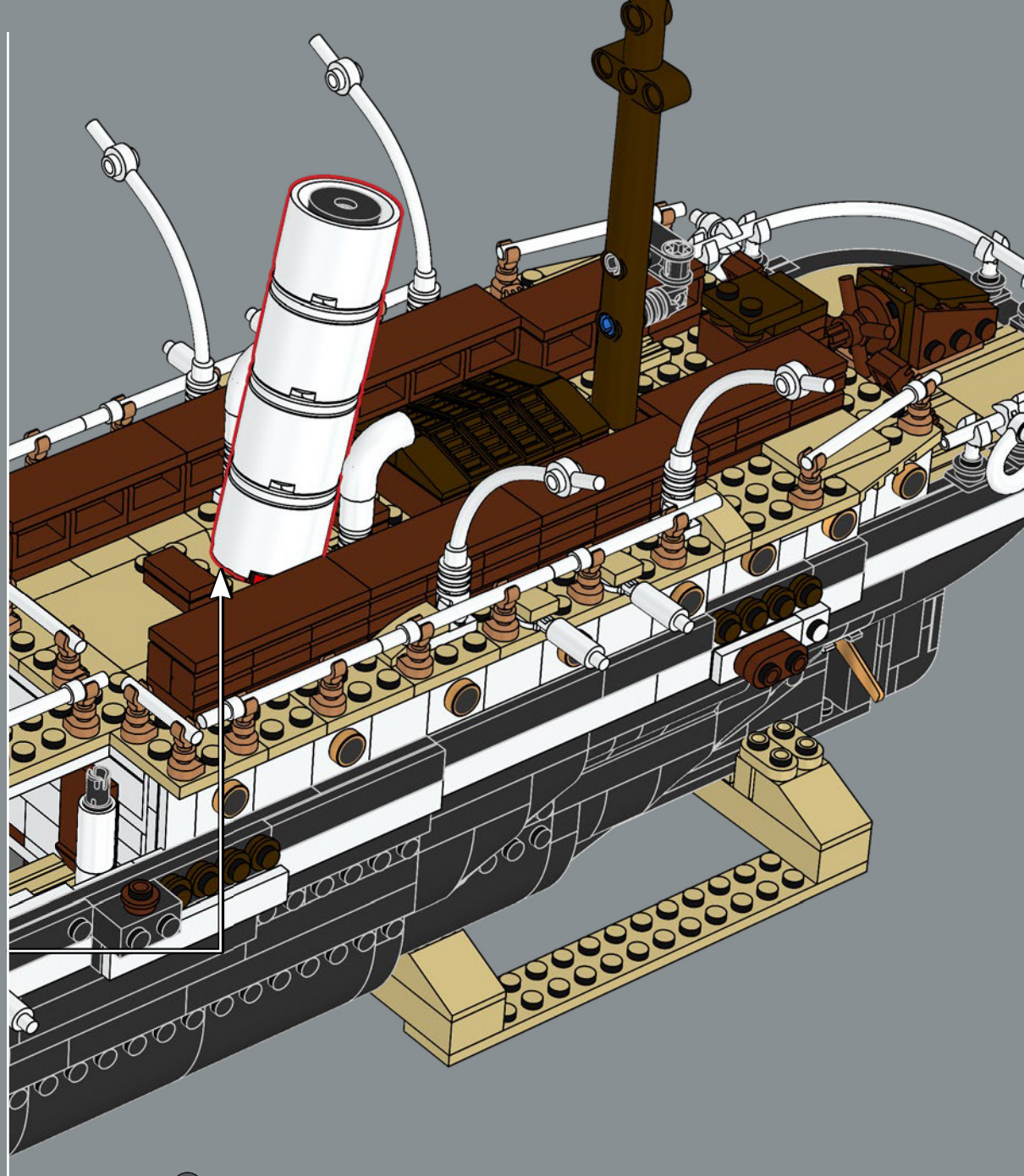
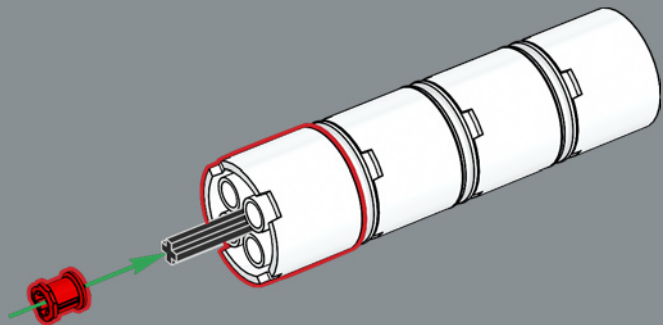

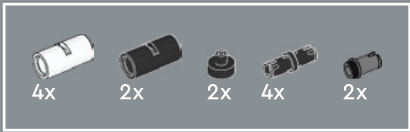

529

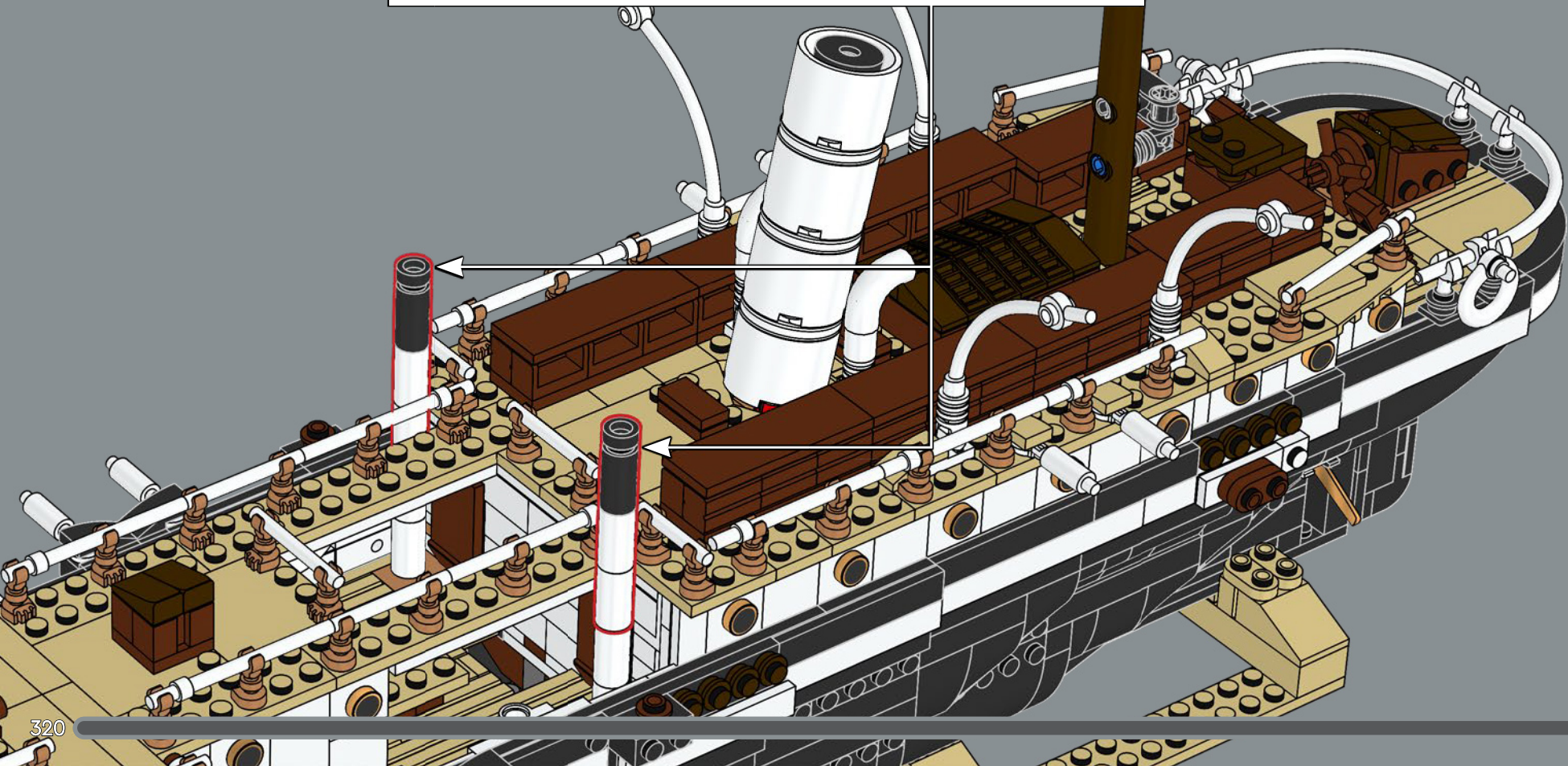
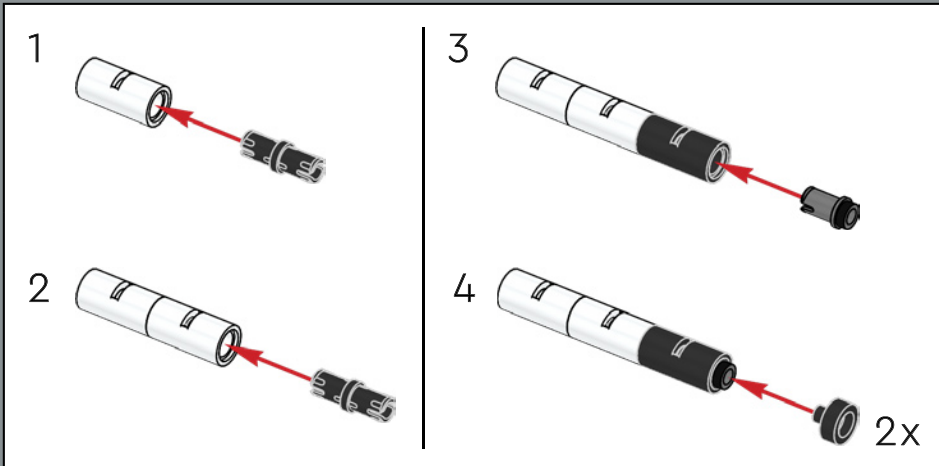

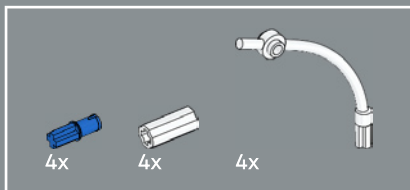

530

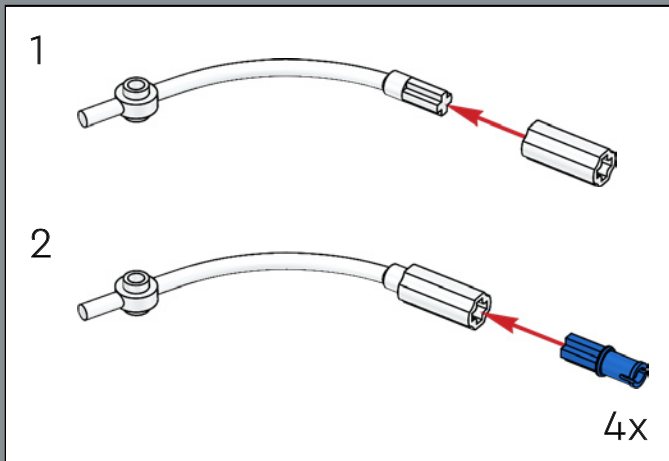

Los brazos curvos que sostienen los cuatro botes salvavidas se diseñaron originalmente como soportes para minifiguras LEGO®.

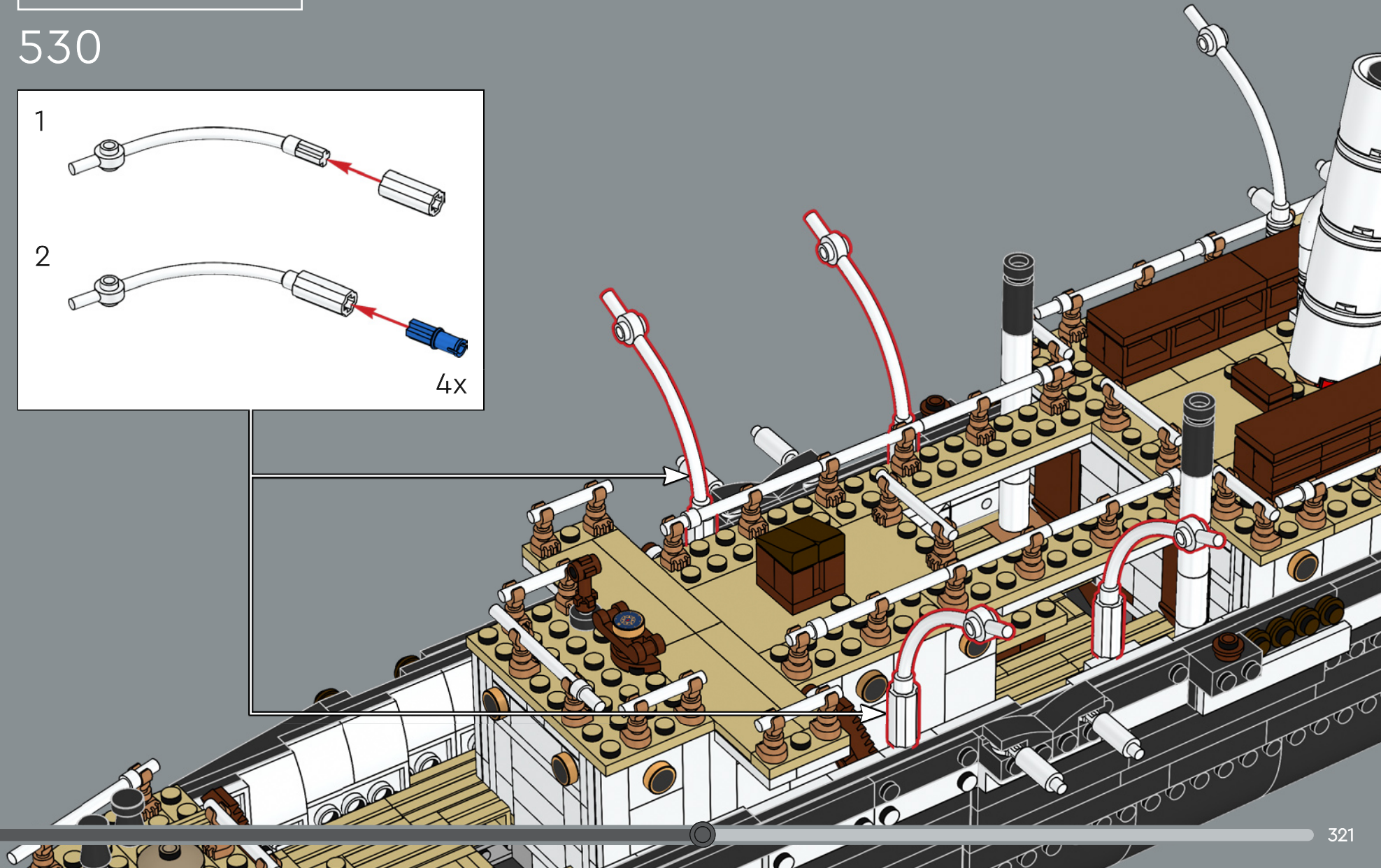

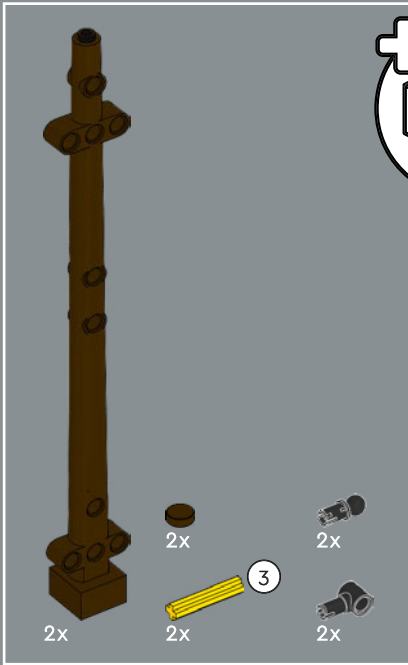
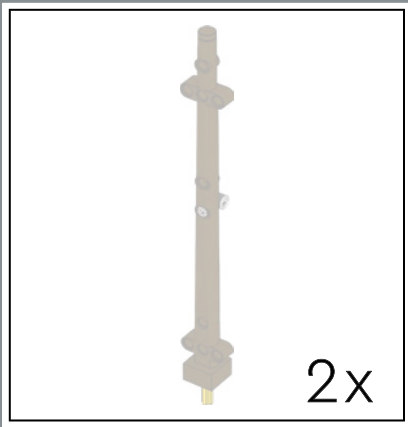

531

1



2

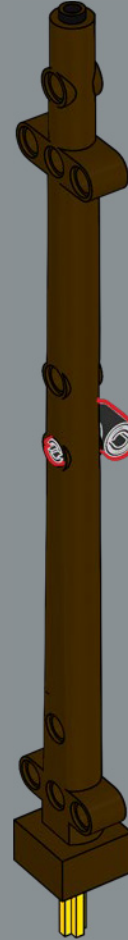

3



2x

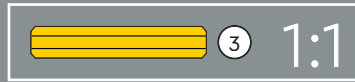

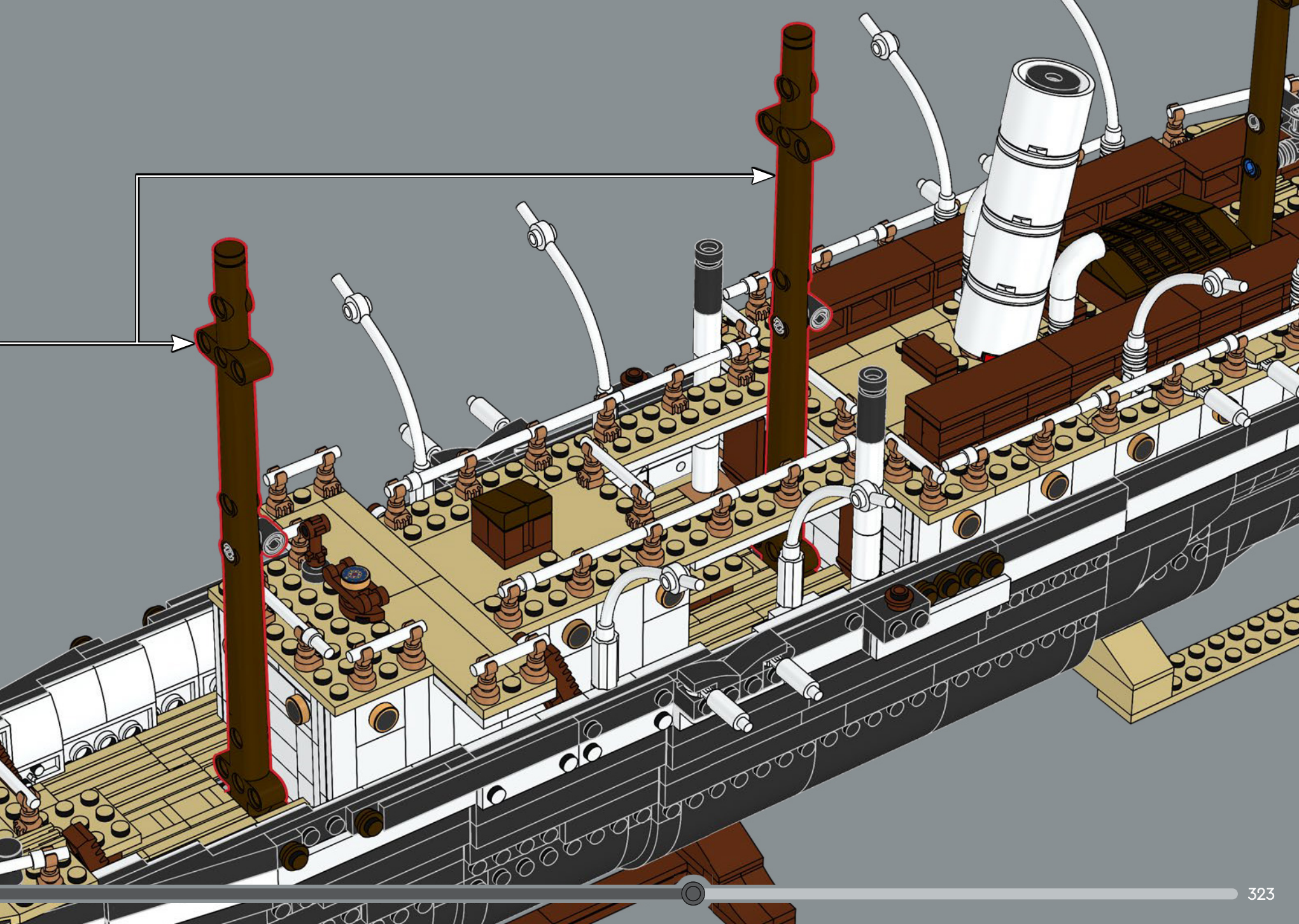

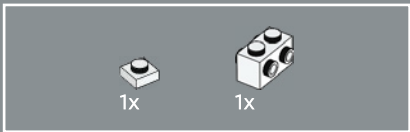
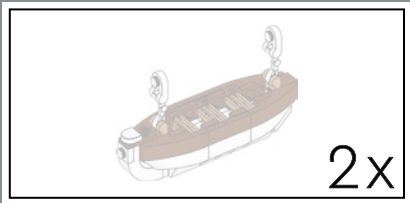

532

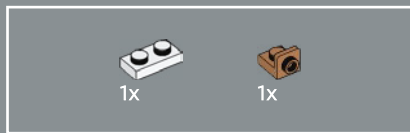
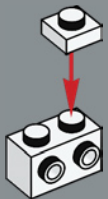

533

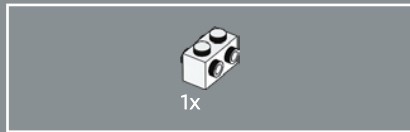
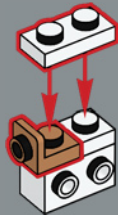

534

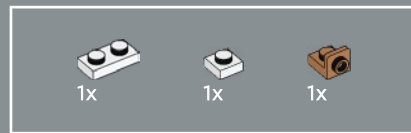
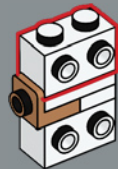

535

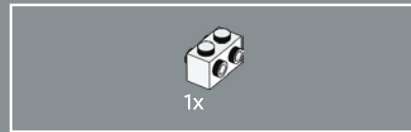

536

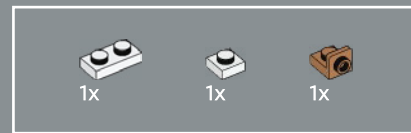
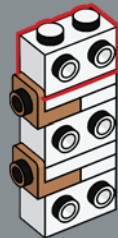

537

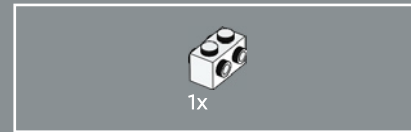

538





539

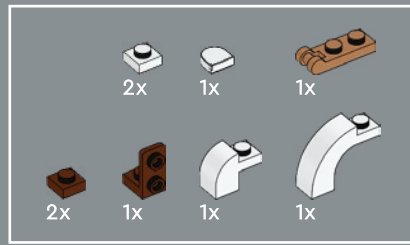
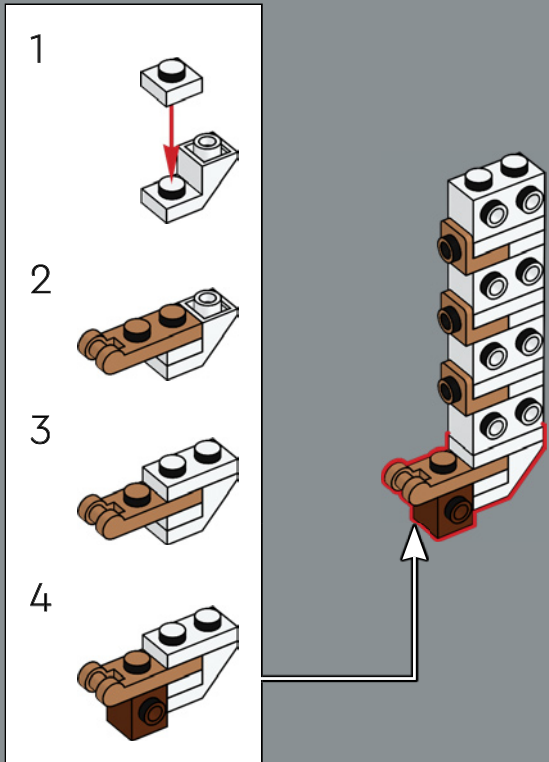

540

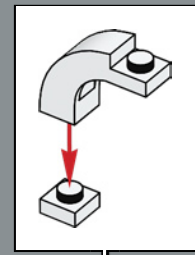
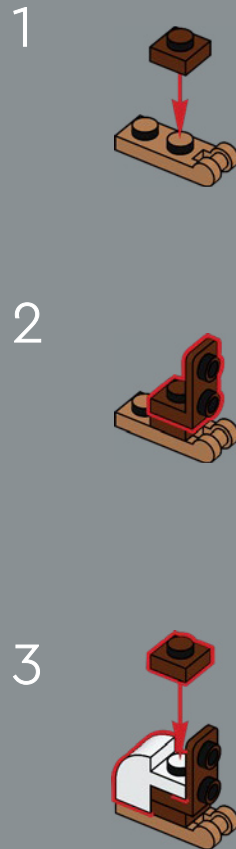

4

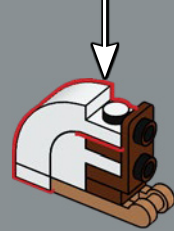

5

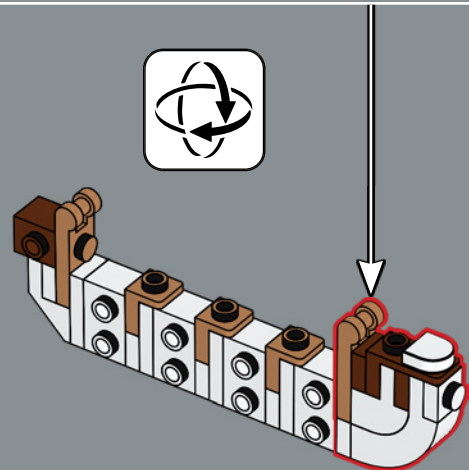
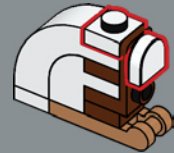

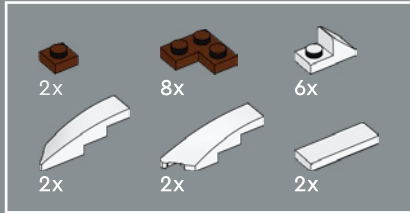
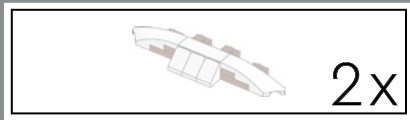

541

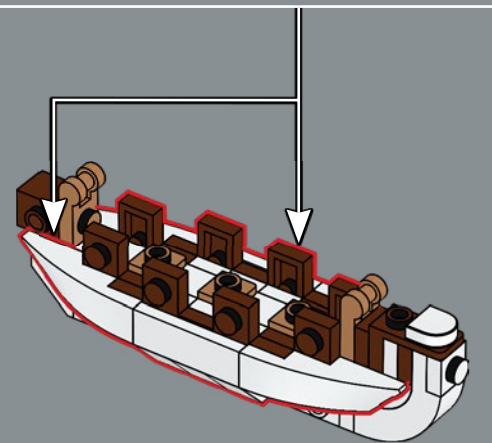
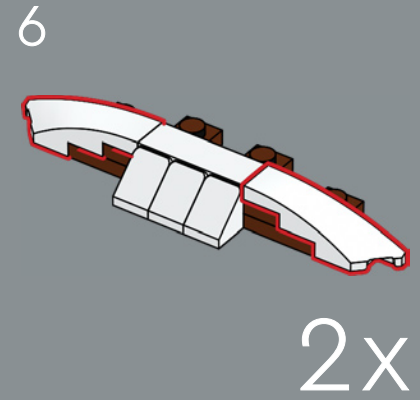
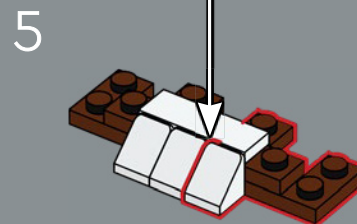
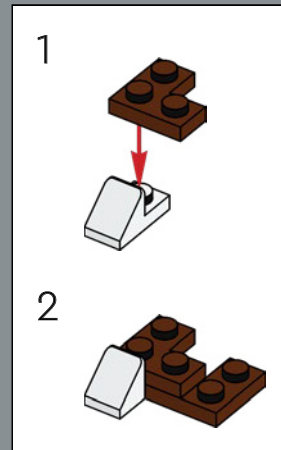
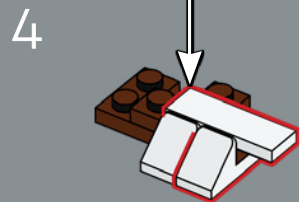
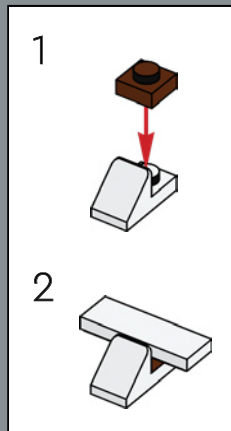
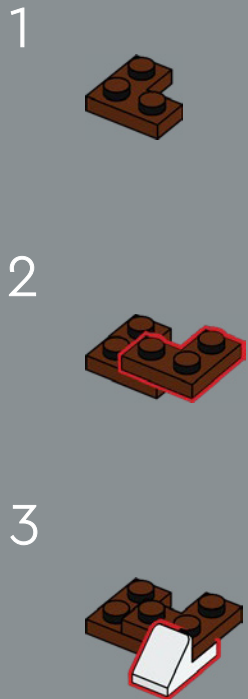



542

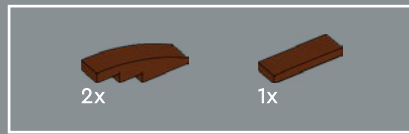
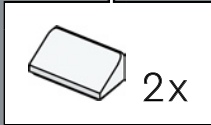
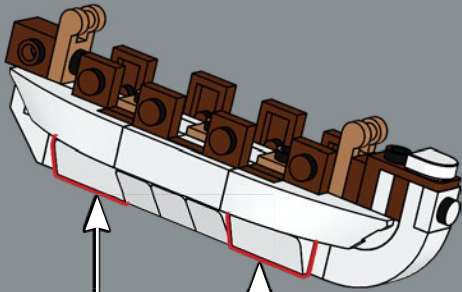

543

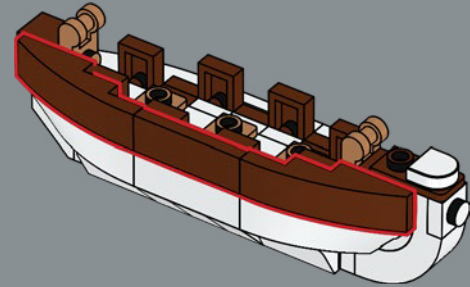

544

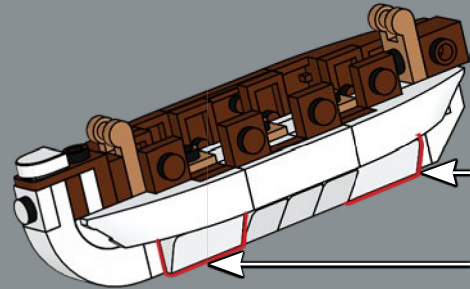



3x

545

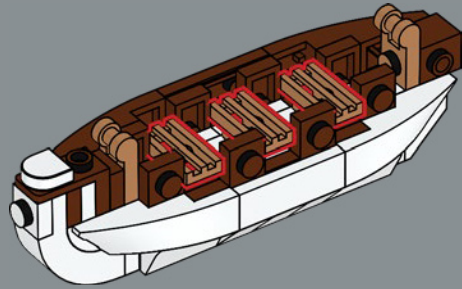

2x

547

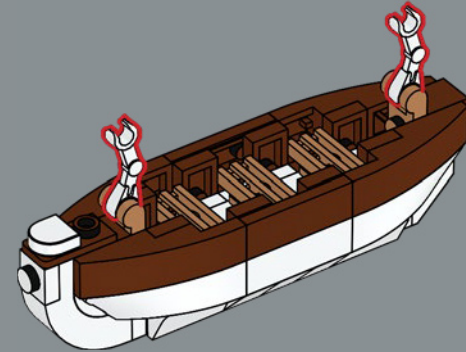

2x



1x

546

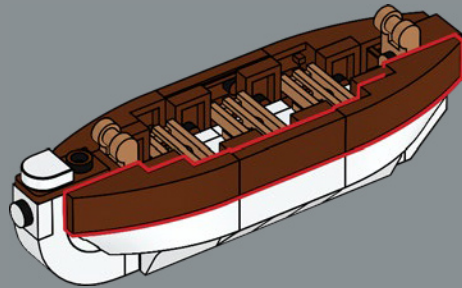

2x

548

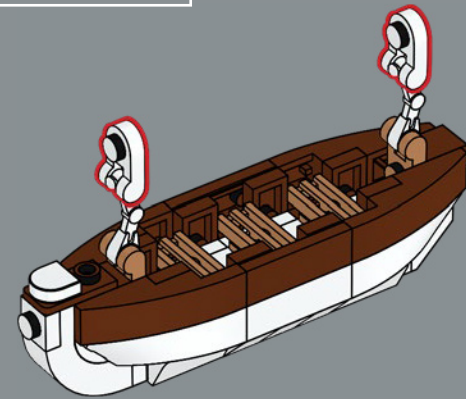

2x

549

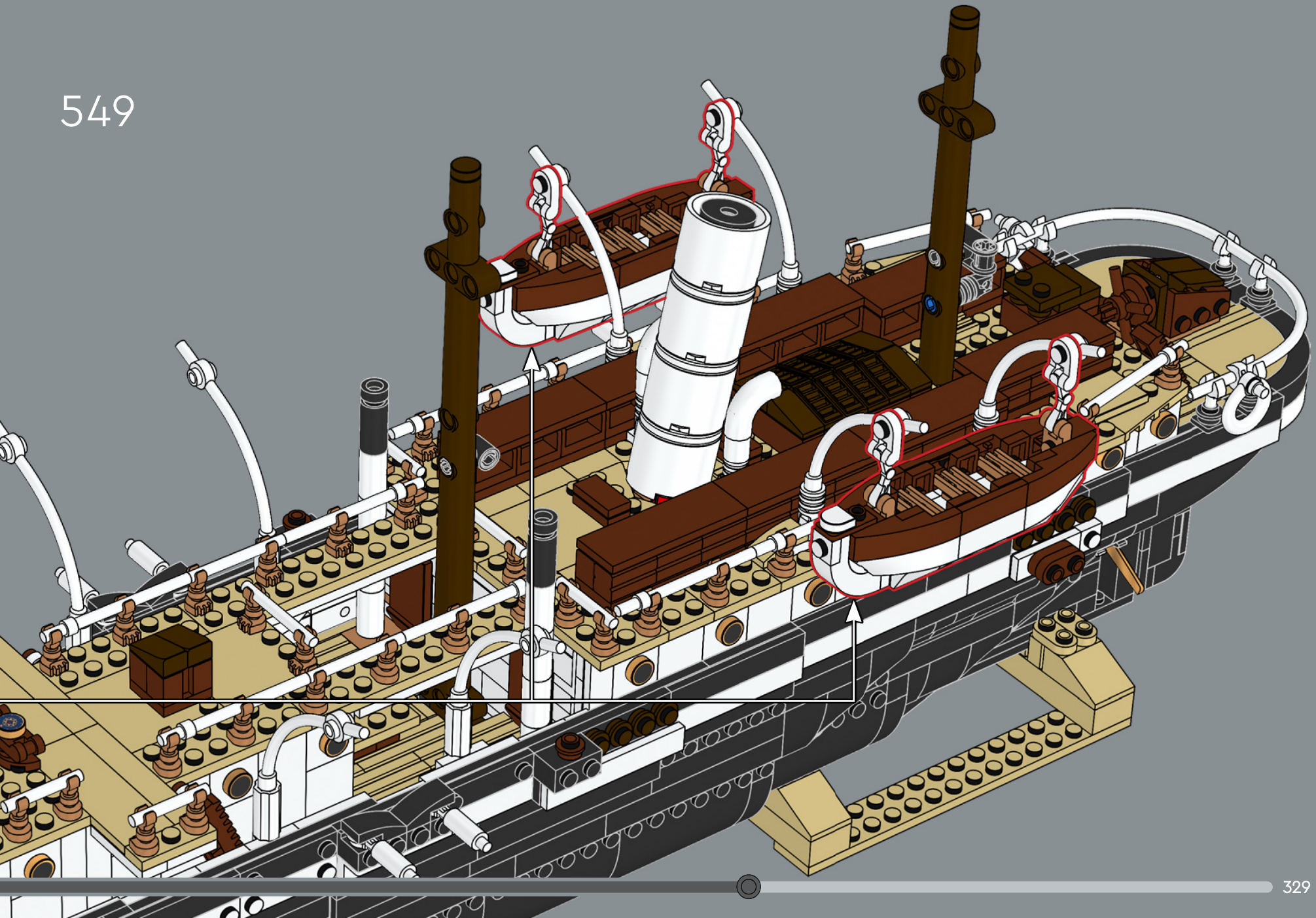

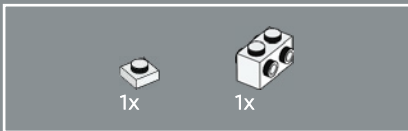
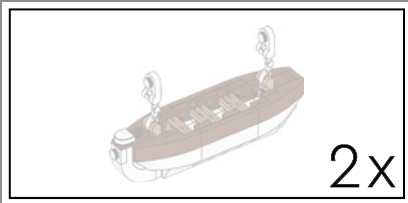

550

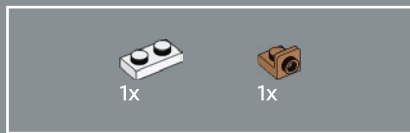
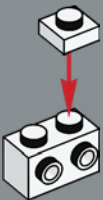

551

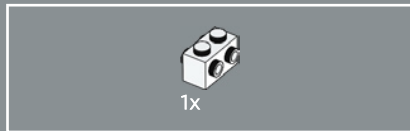
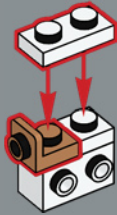

552

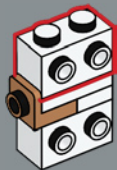

553

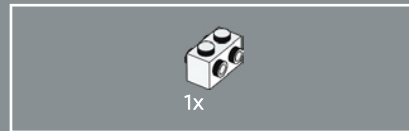

554

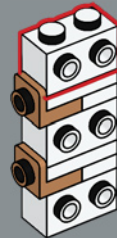

555

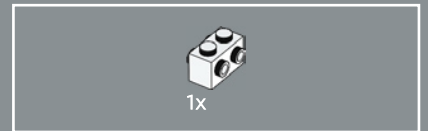

556

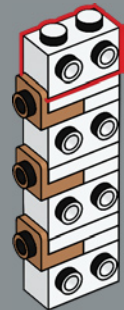

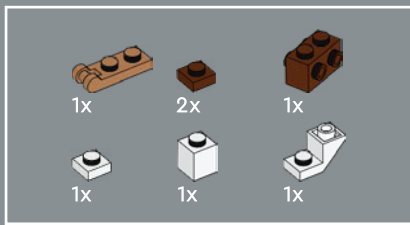

557

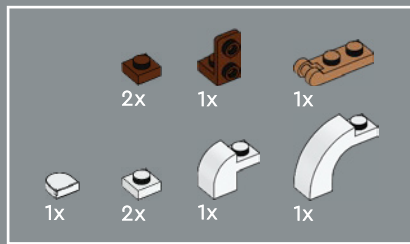
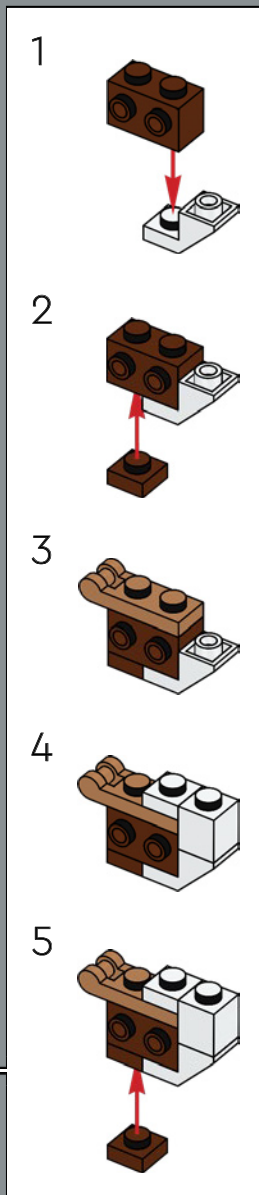
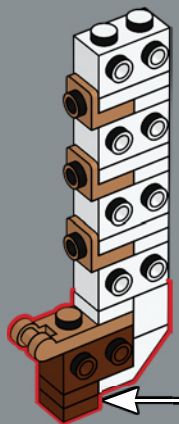

558

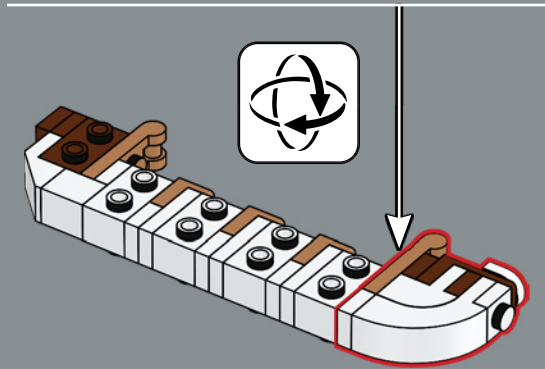
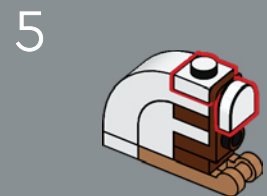
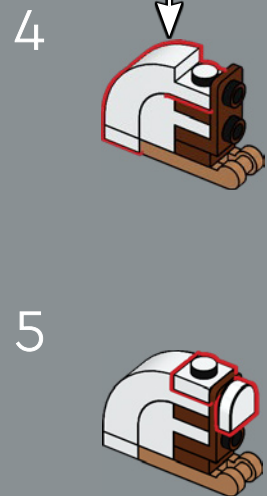
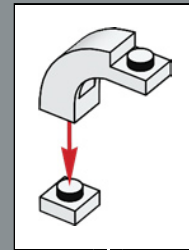
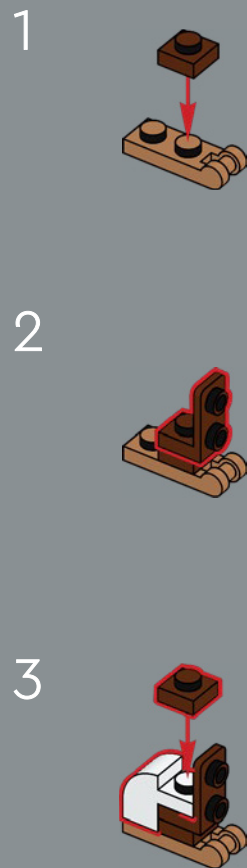

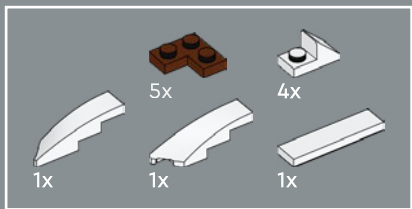

559

1



2



3



1

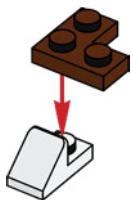

2



3

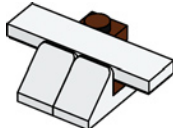

4

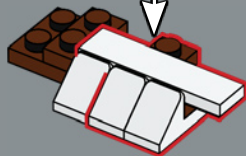

1

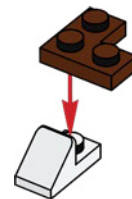

2

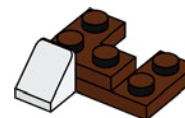

5

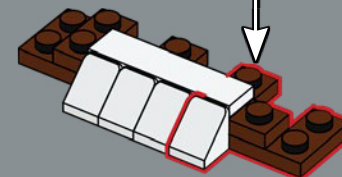

6

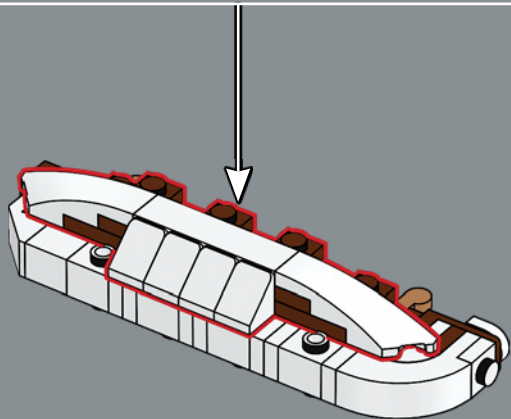
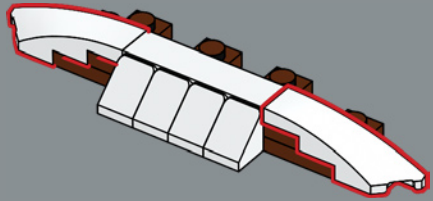

2x

560

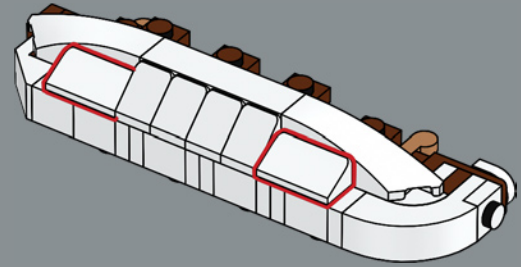

1x

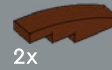

2x

561

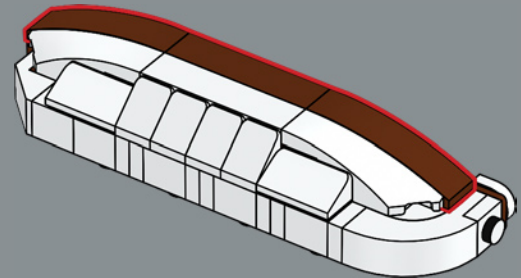

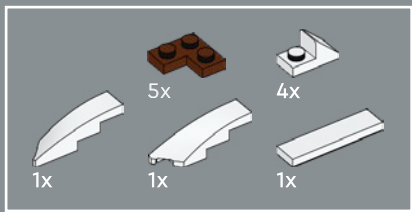

562

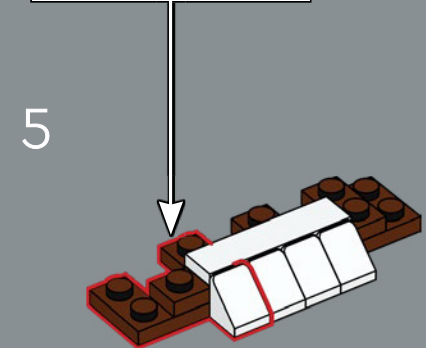
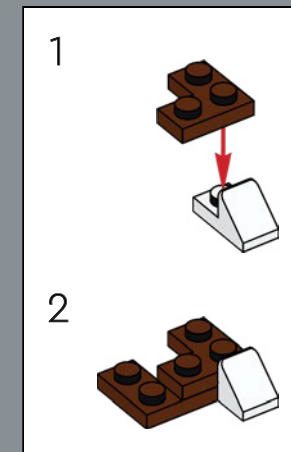
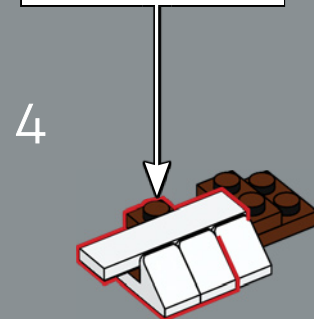
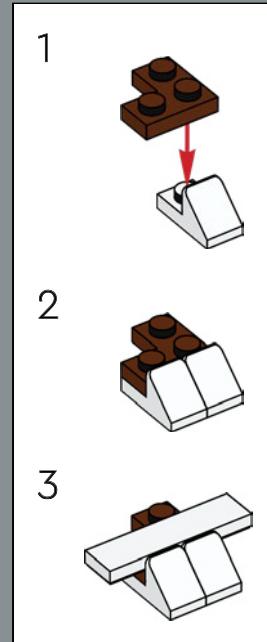
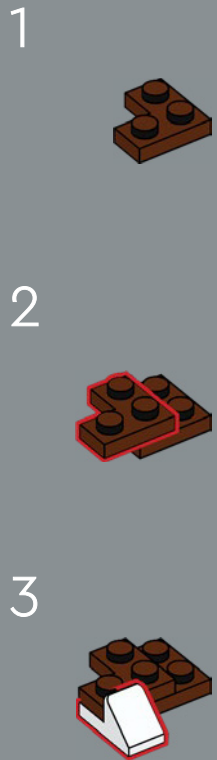

6

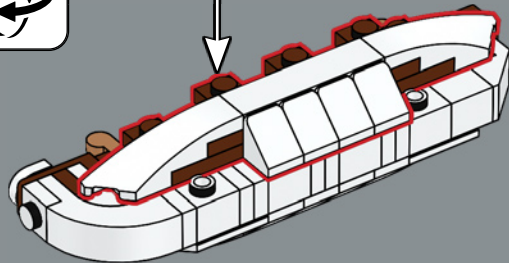
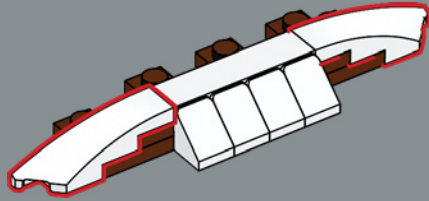

563

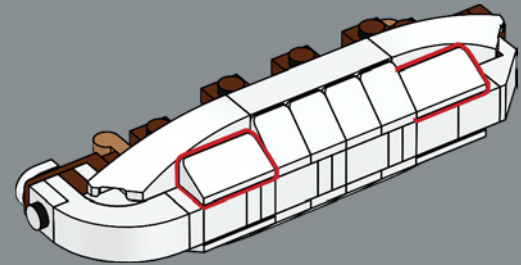



3x

564

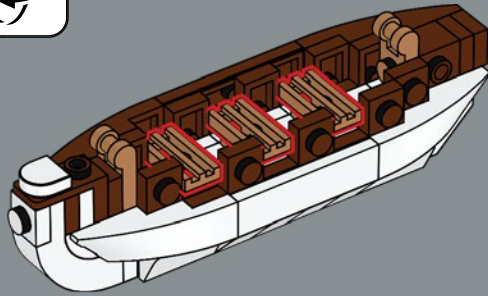

1x



2x

565

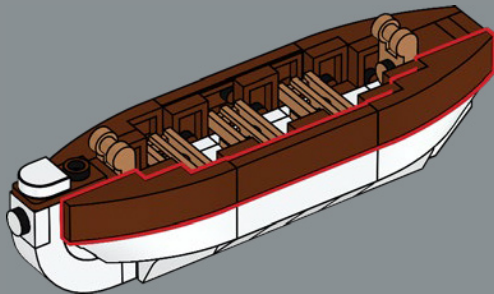

2x

566

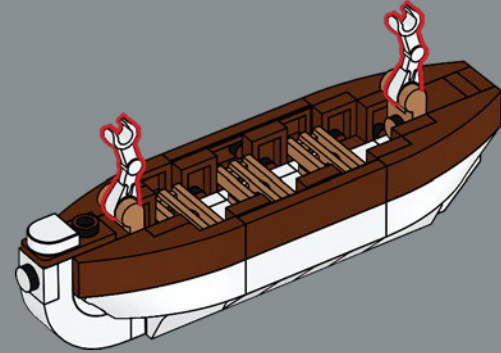

2x

567

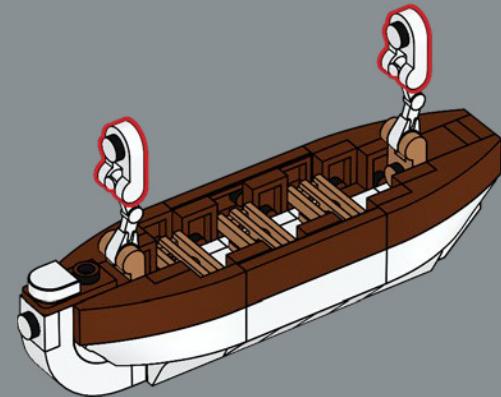

2x

568

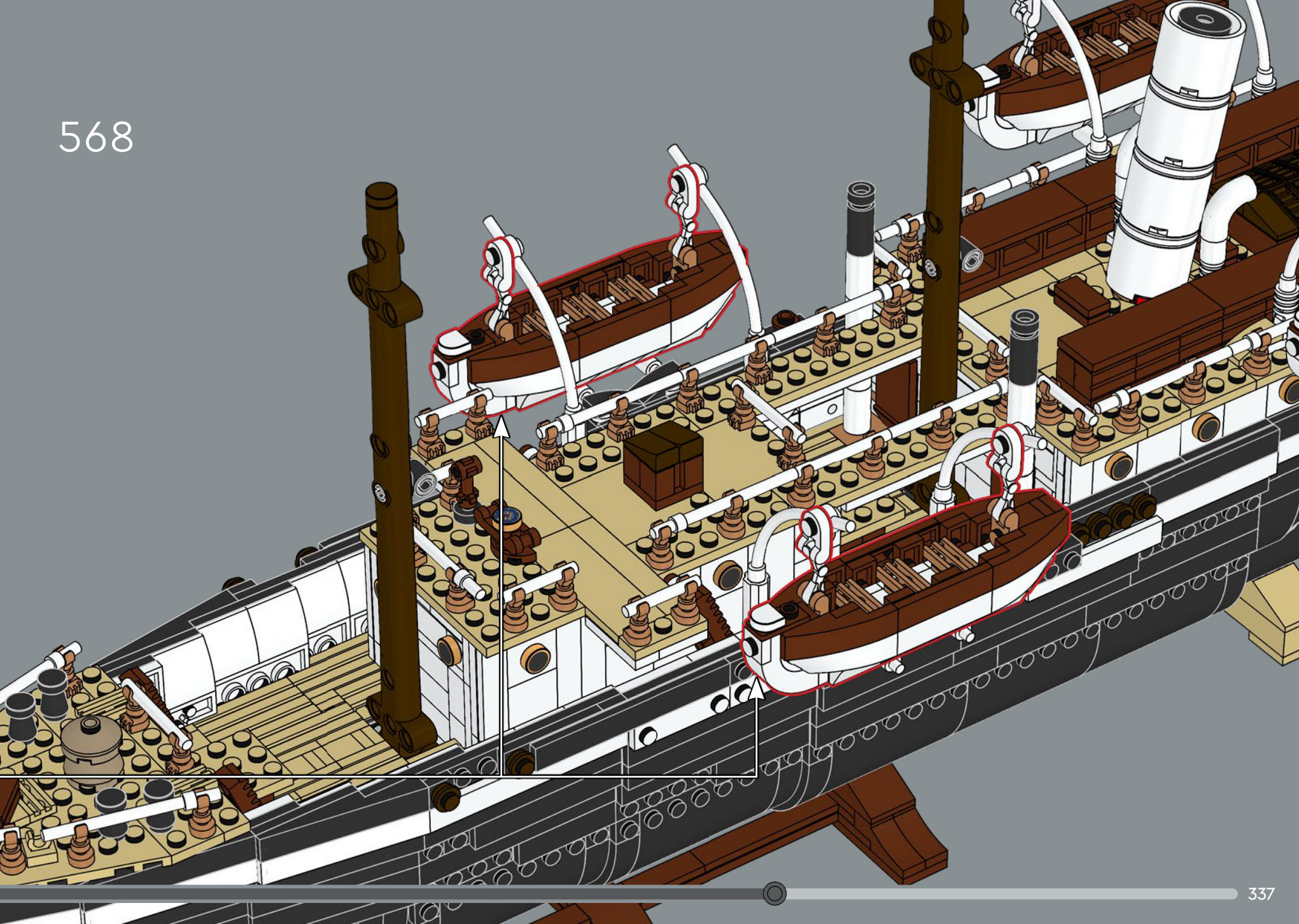

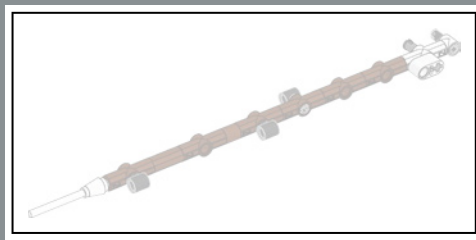

569

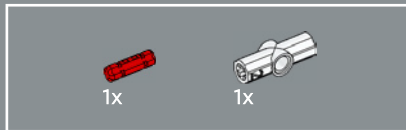
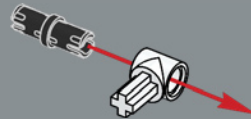

570

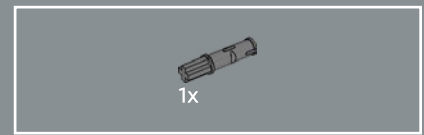
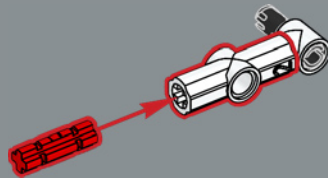

571

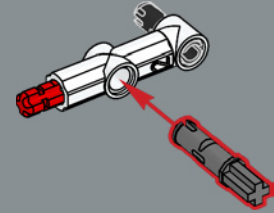

572

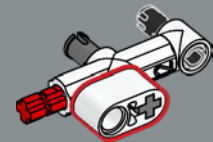

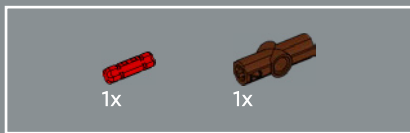

573

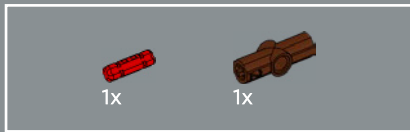
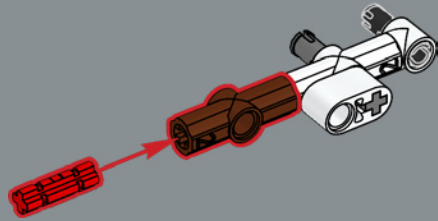

574

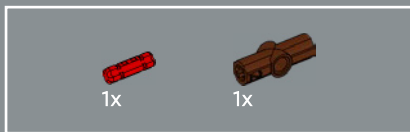
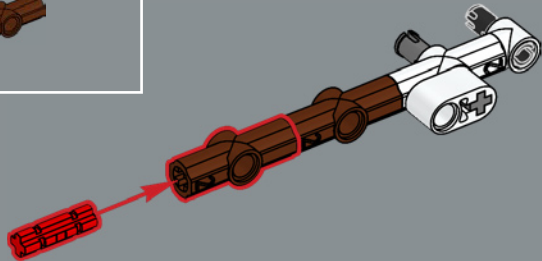

575

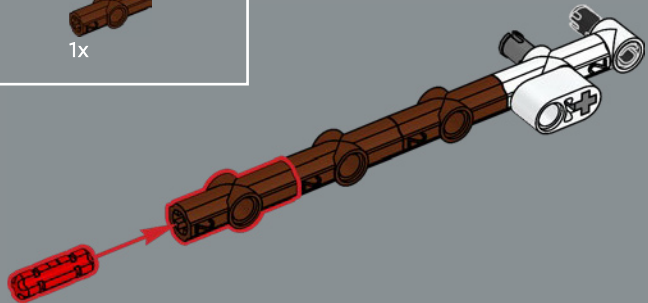

576

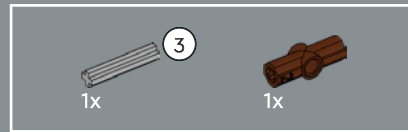
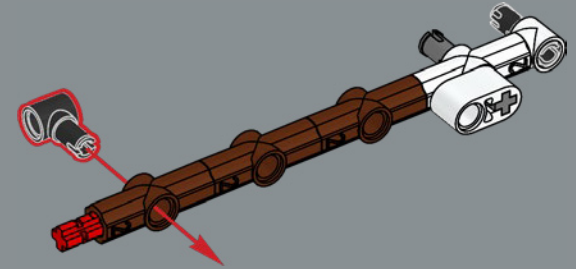

577

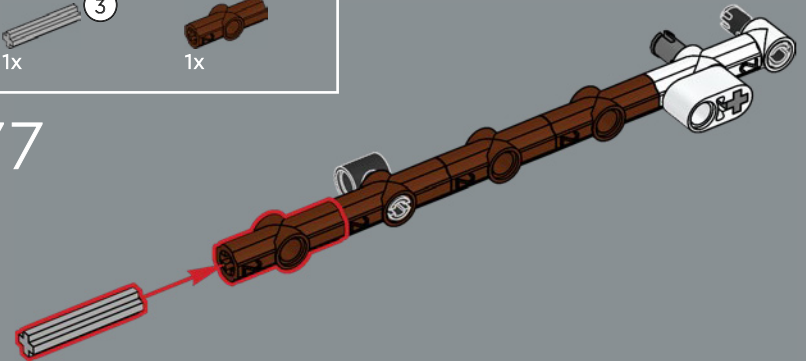

578

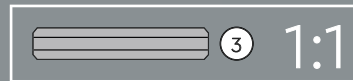
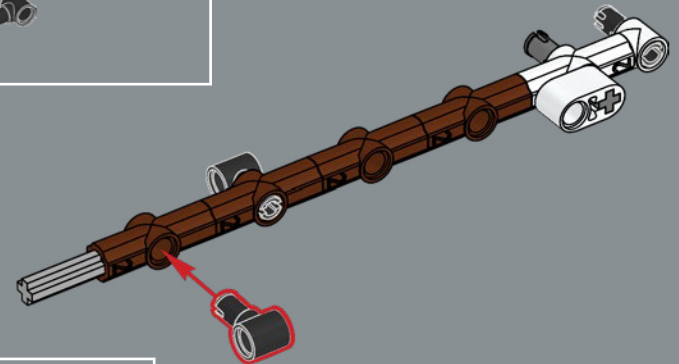

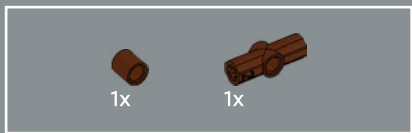

579

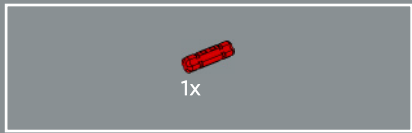
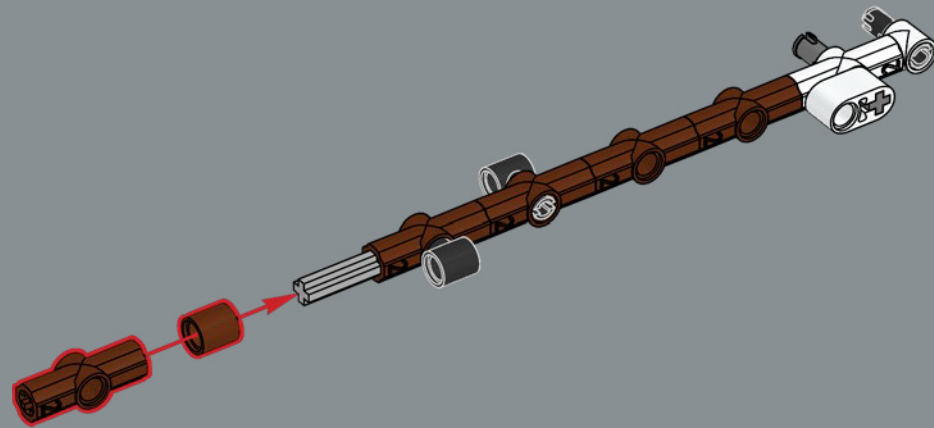

580

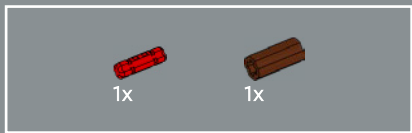
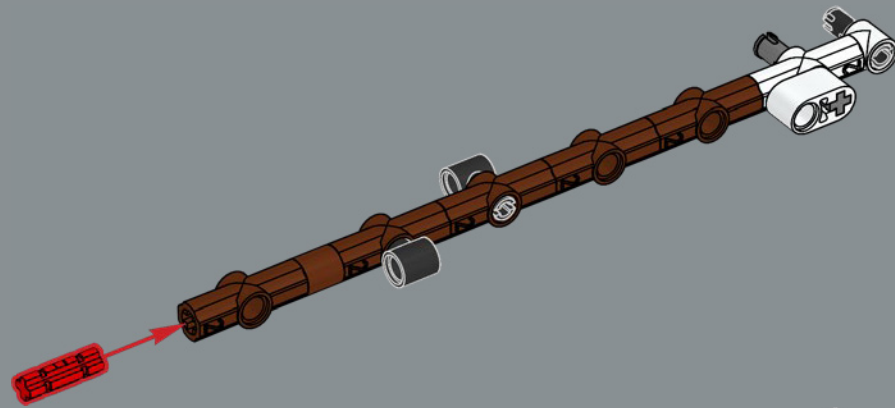

581

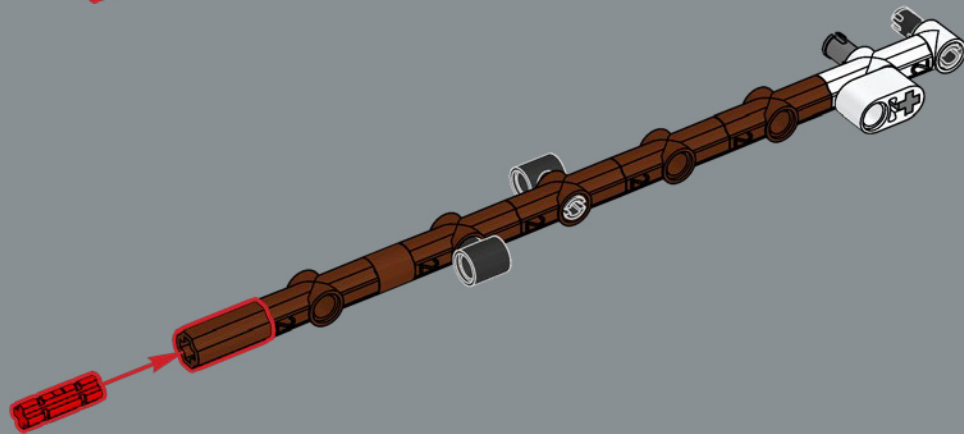



582

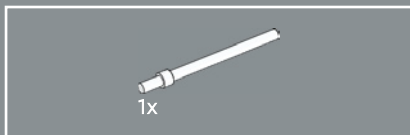
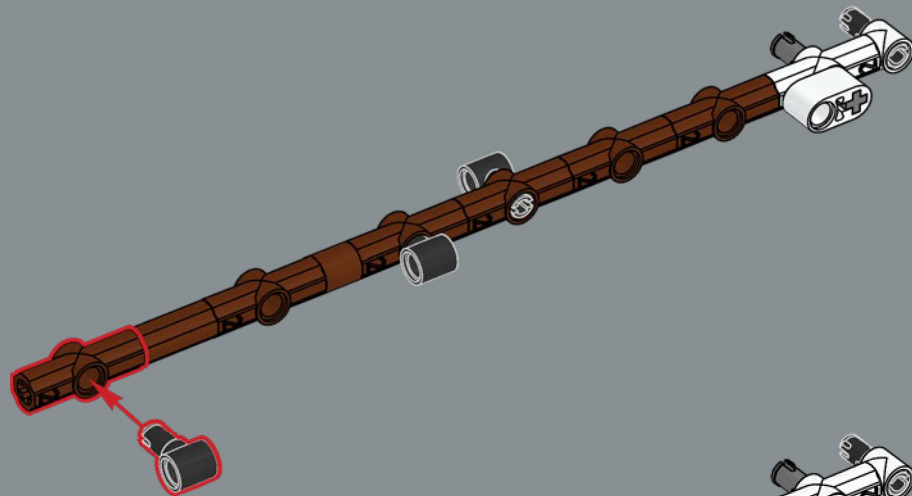

583

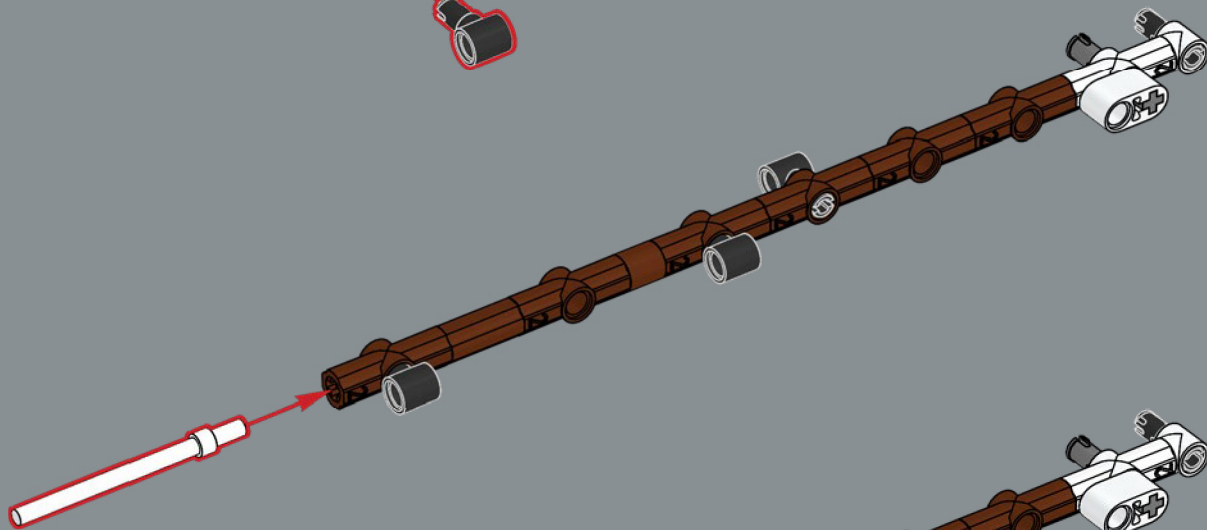

584

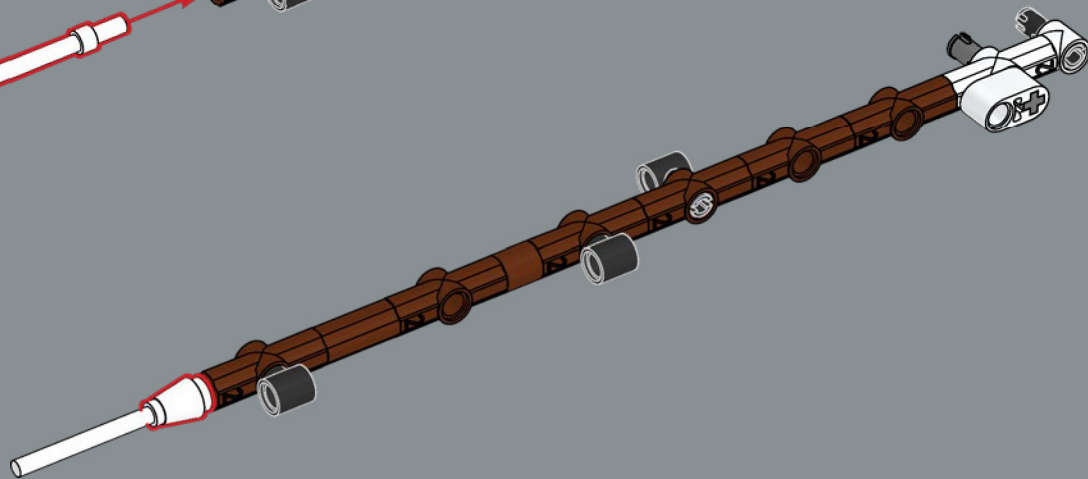

585

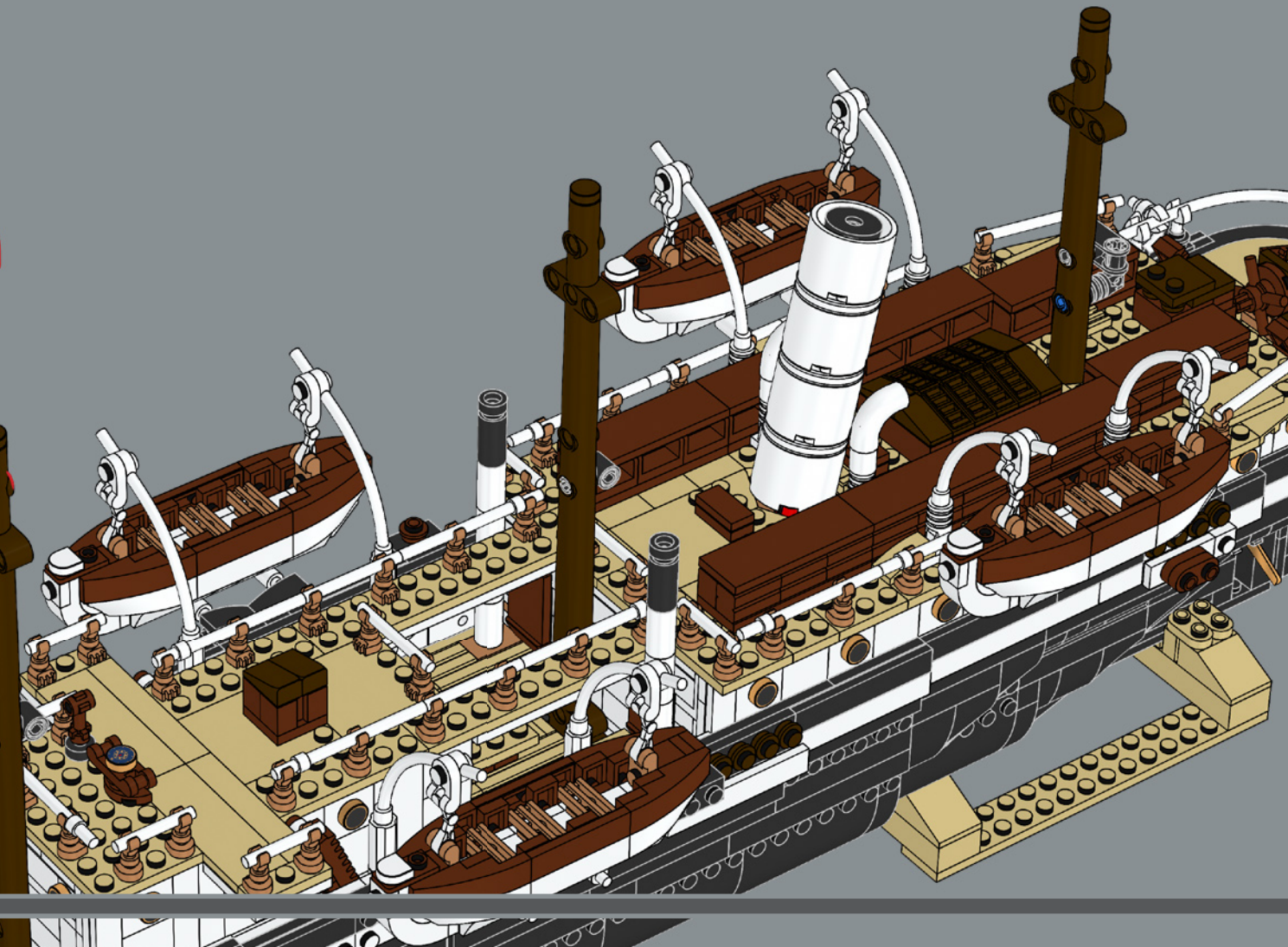
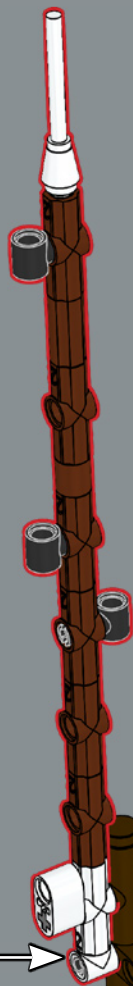

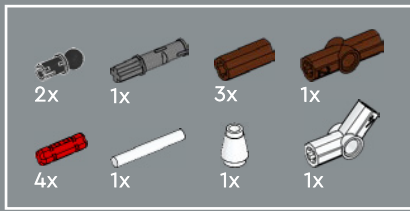

586

1

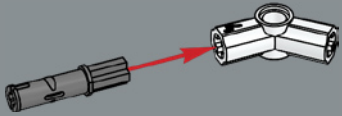

2

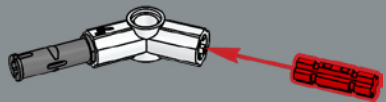

3

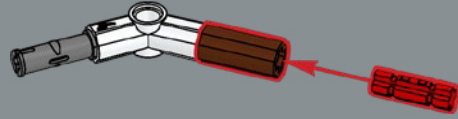

4



5

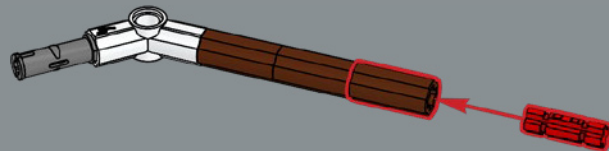

6

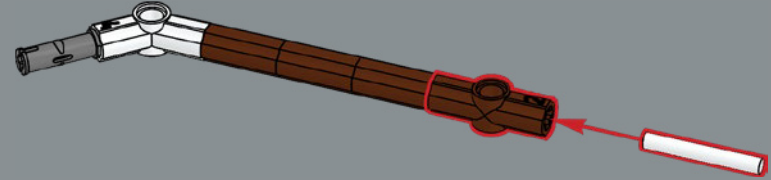

7

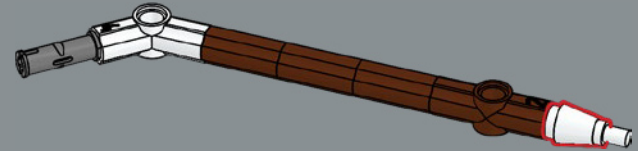

8

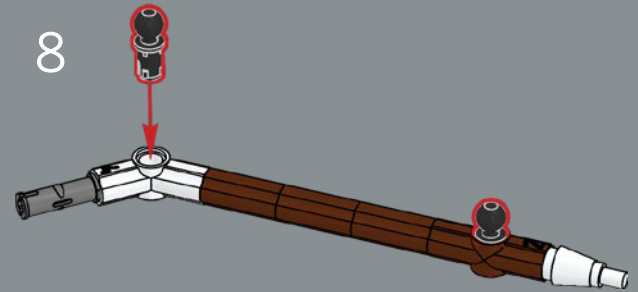

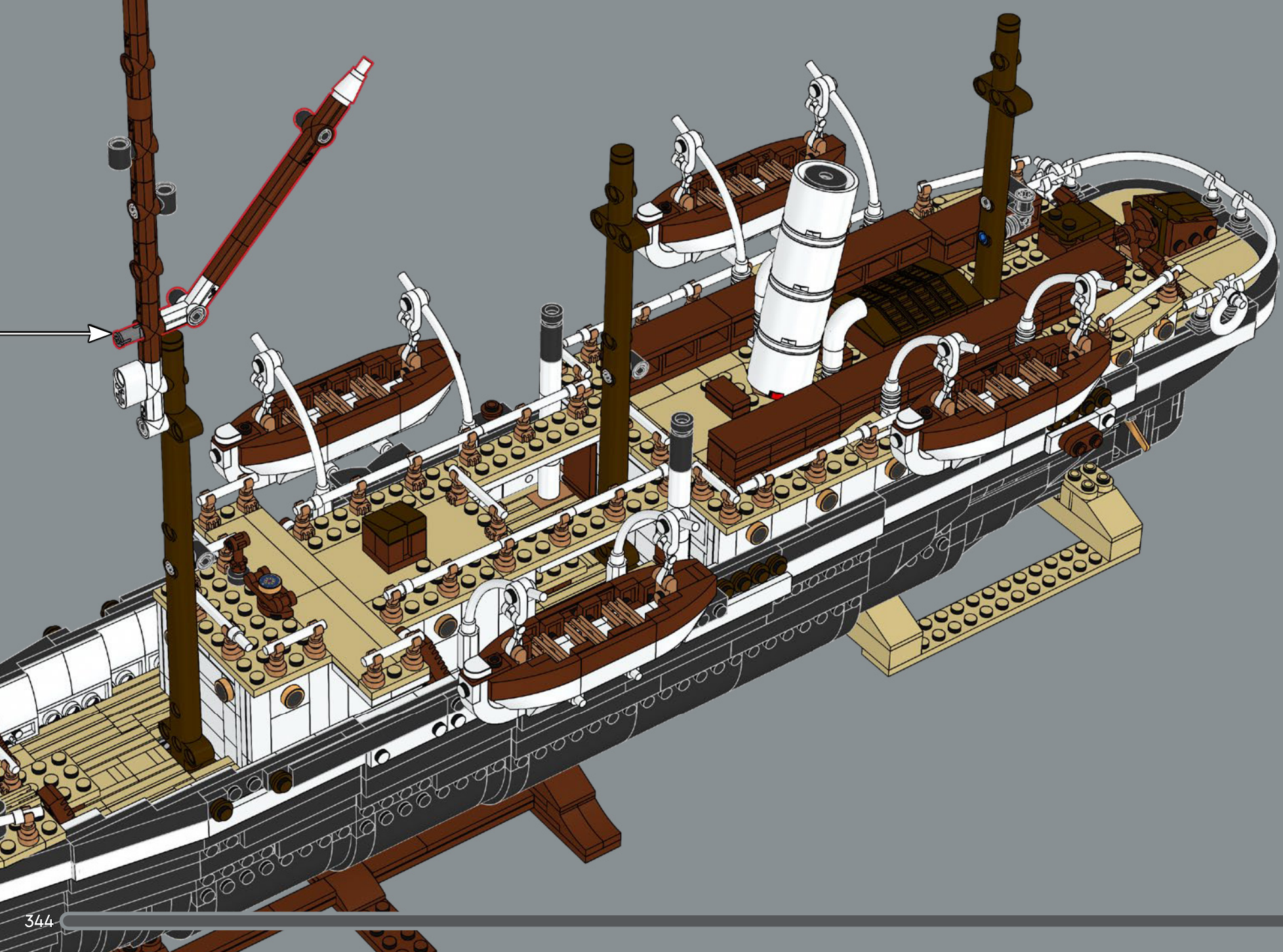

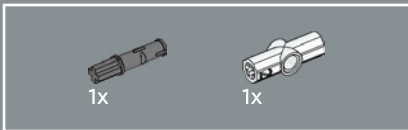
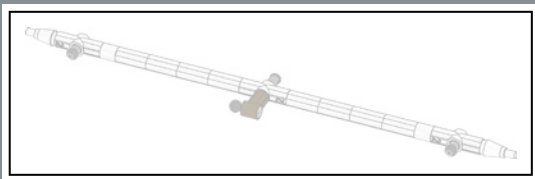

587

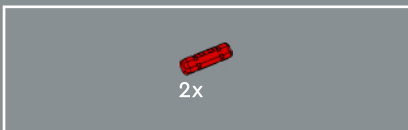
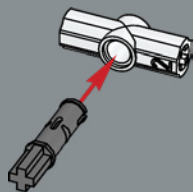

588

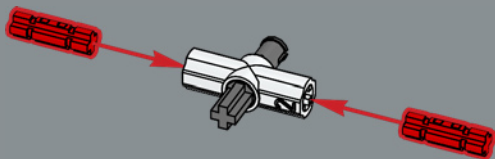

589

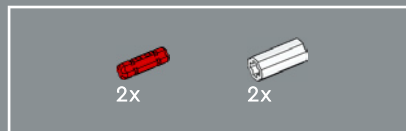
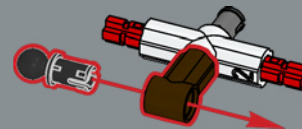

590

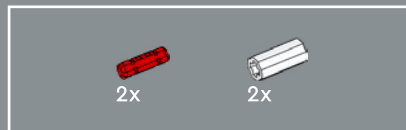
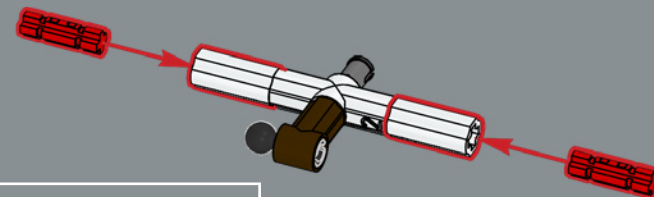

591

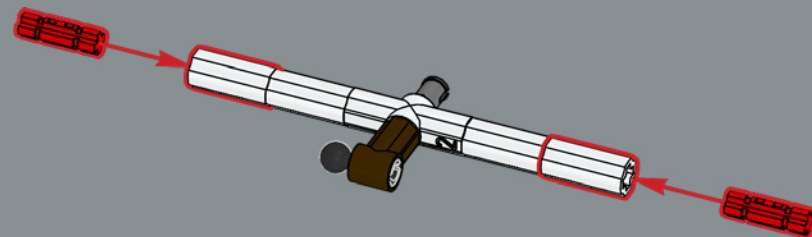

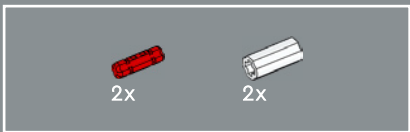

592

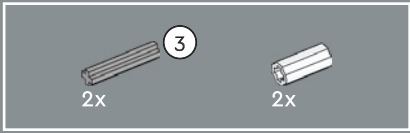
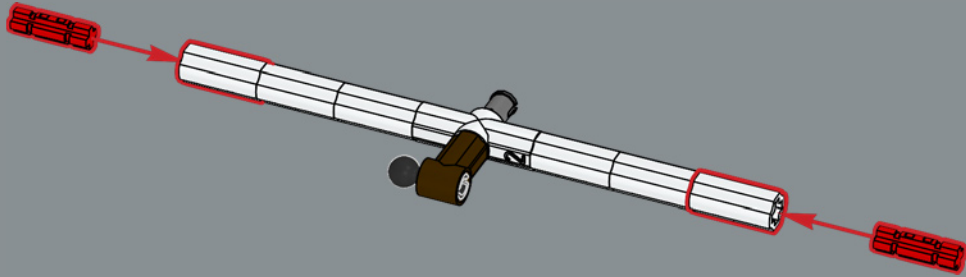

593

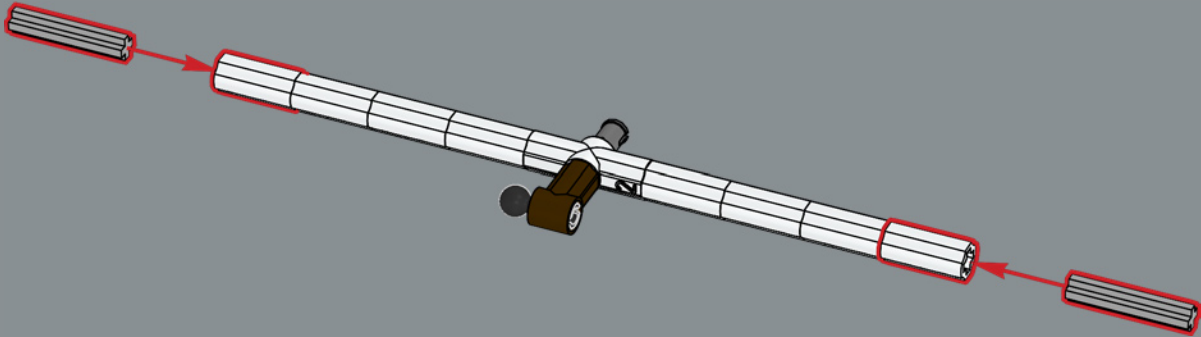

594

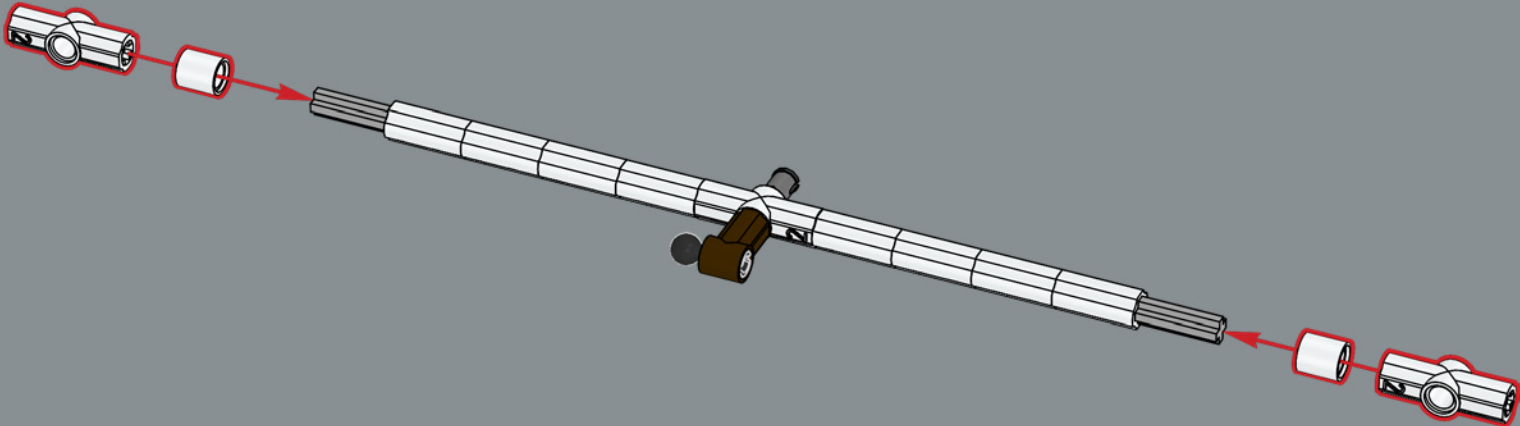



595

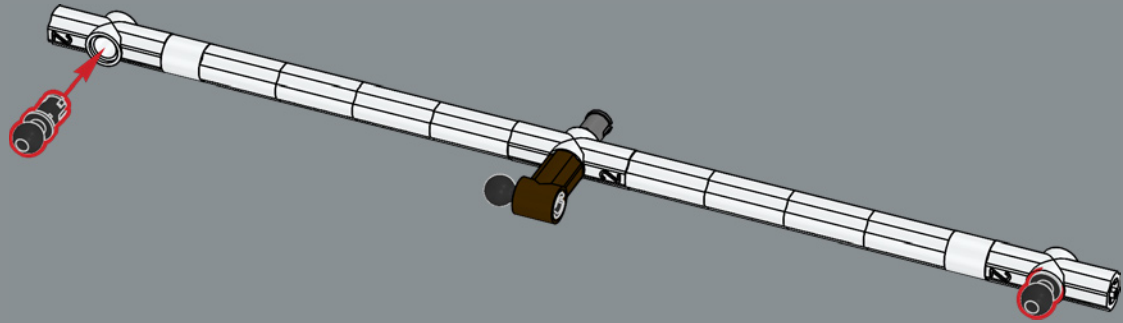

596

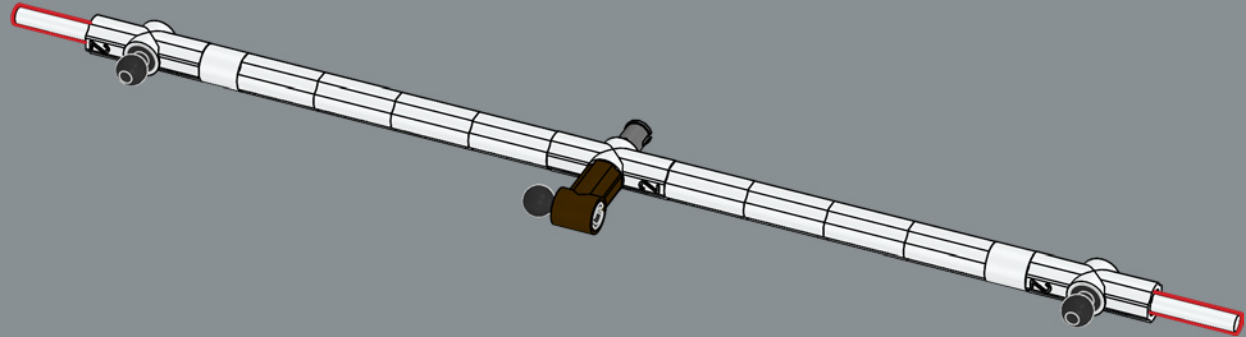

597

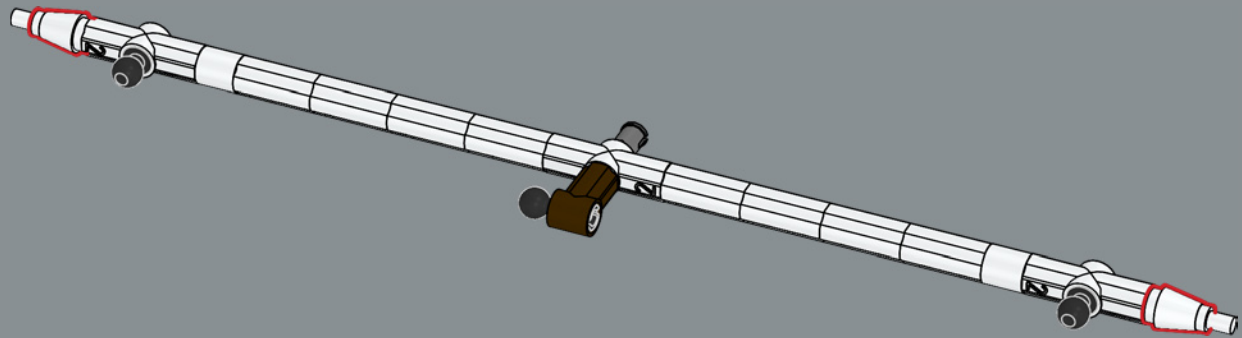

598

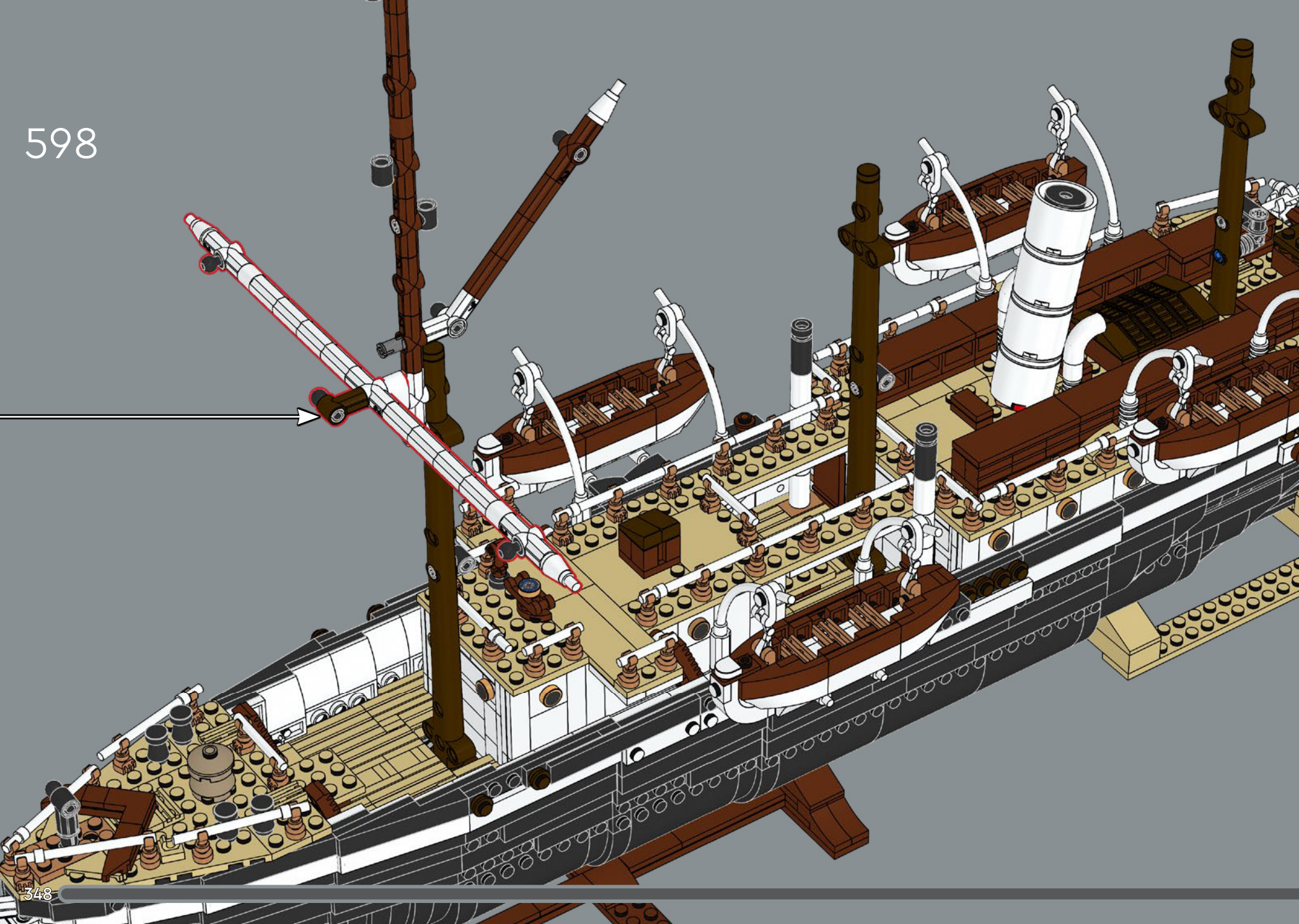



599

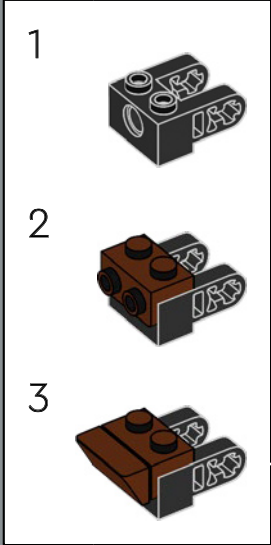

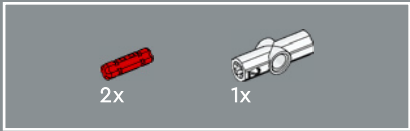
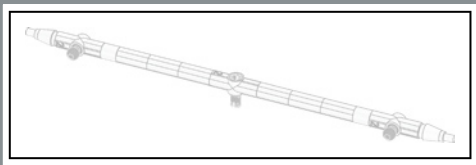

600

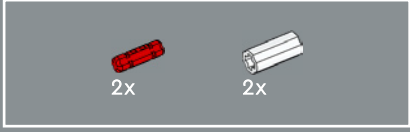
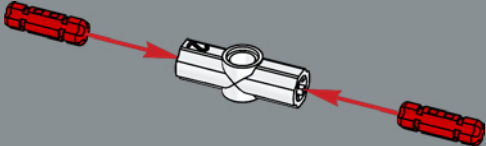

601

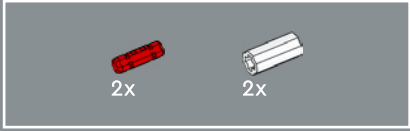
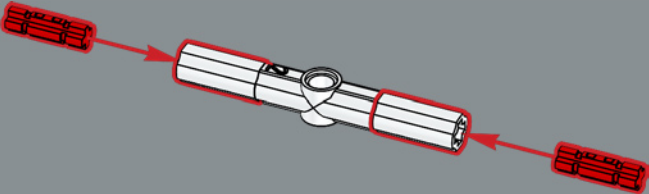

602

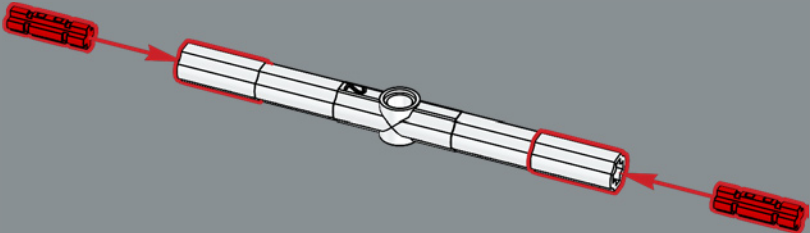

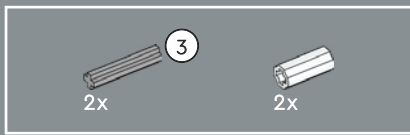

603

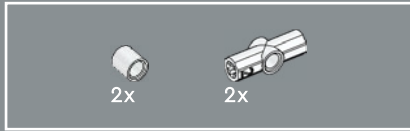
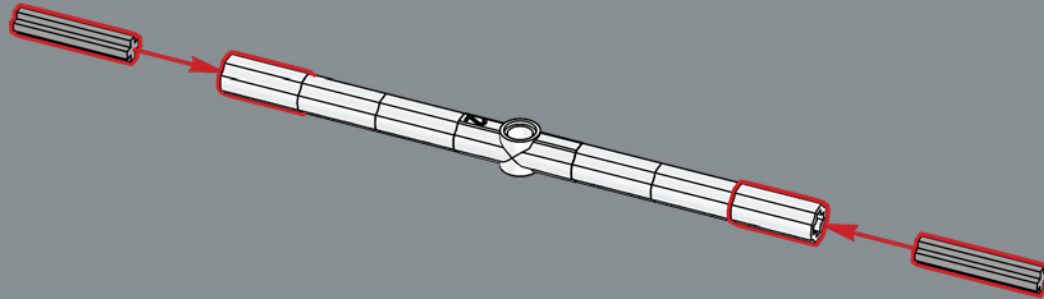

604

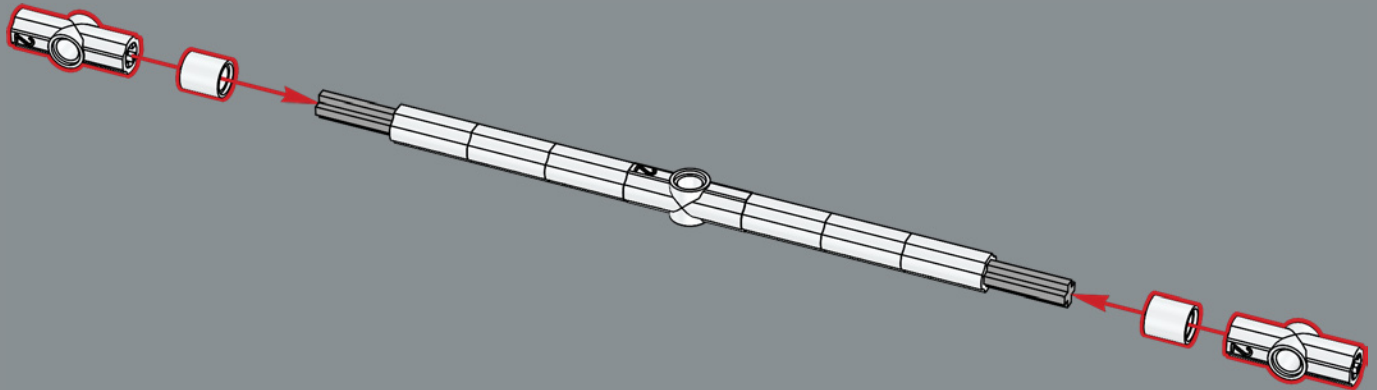

605

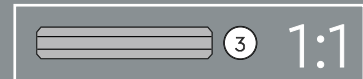
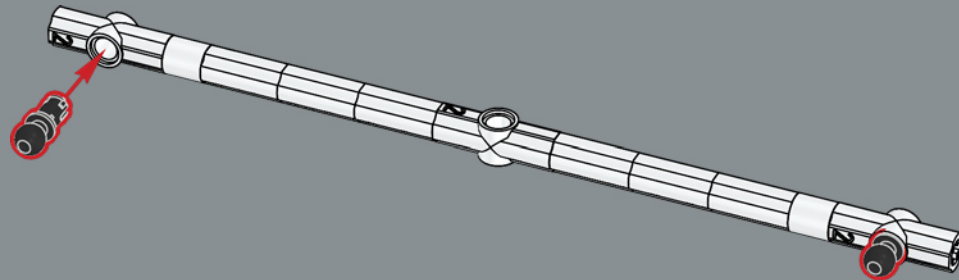



606

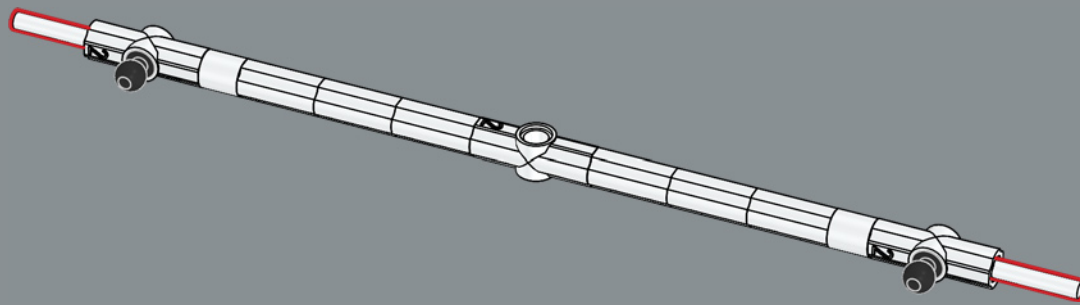

607

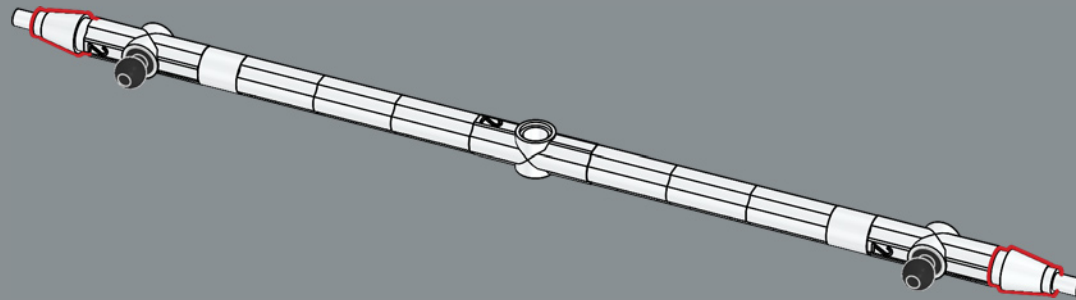

608

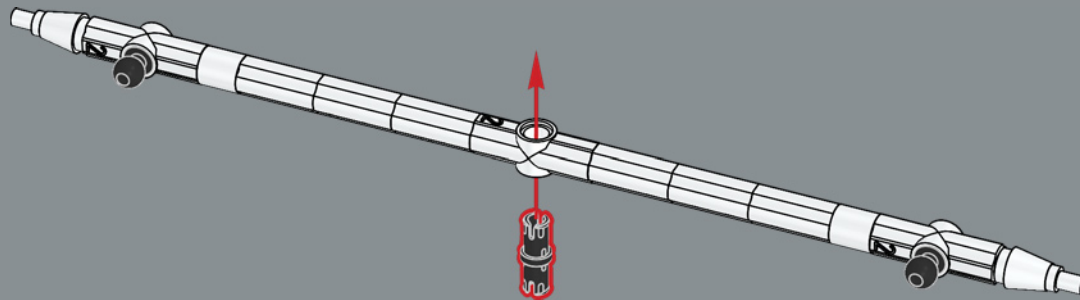

609



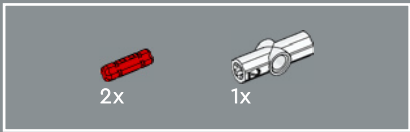
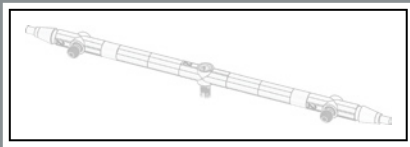

610

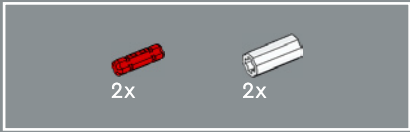
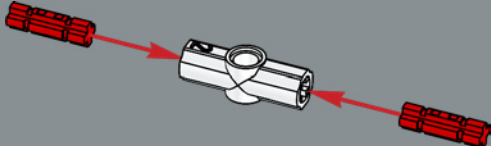

611

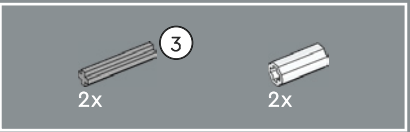
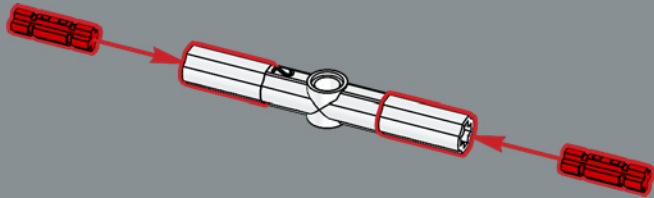

612

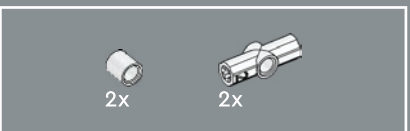
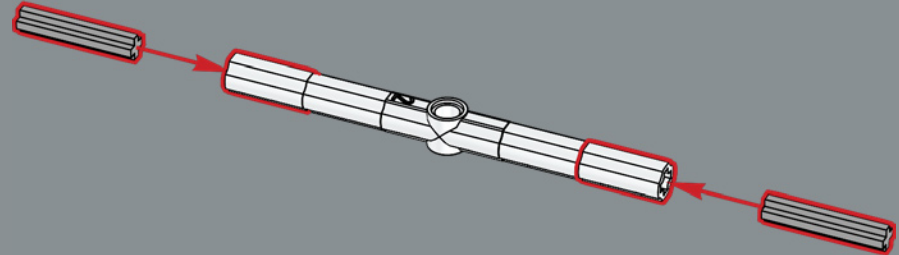

613

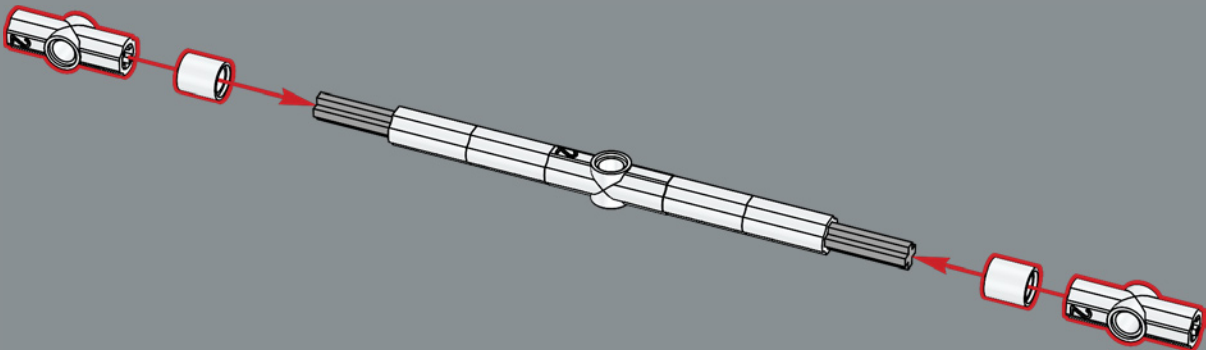



614

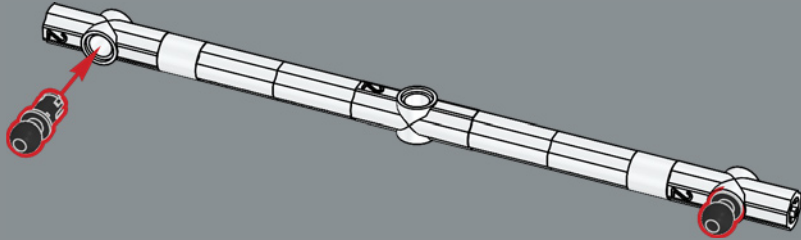

615

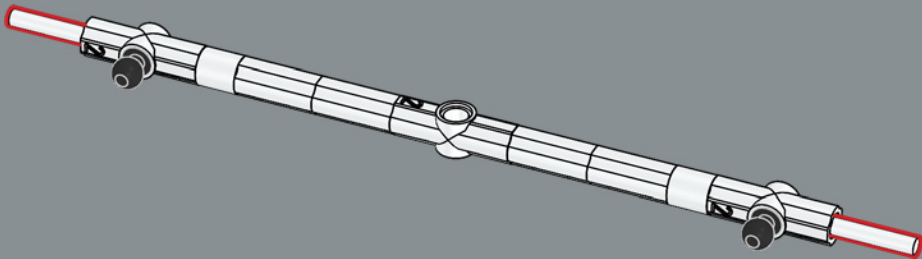

616

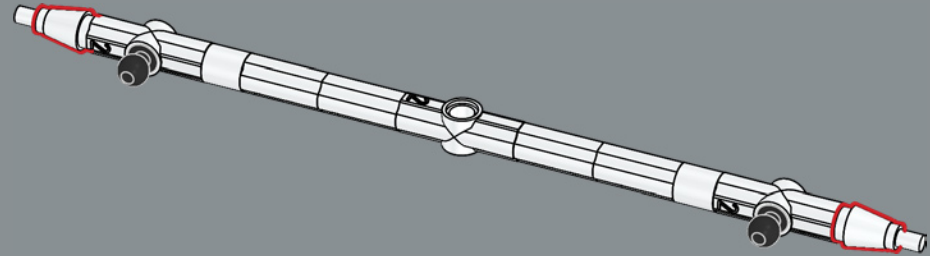

617

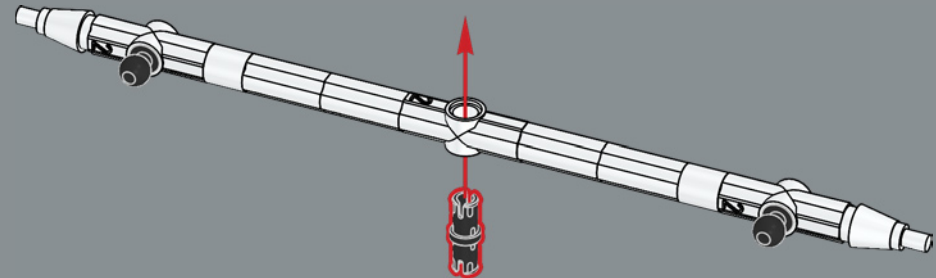

618



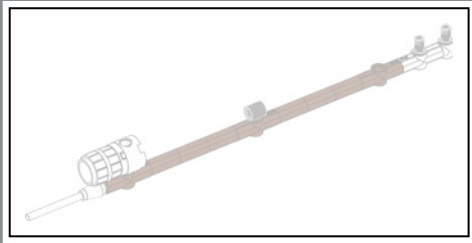

619

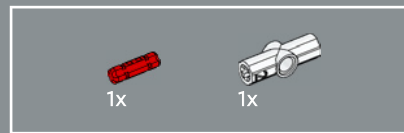
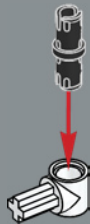

620

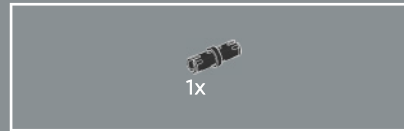
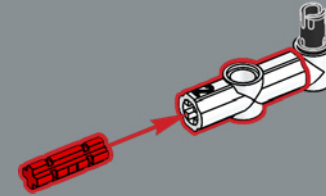

621

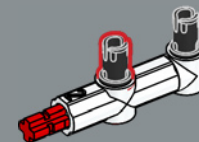

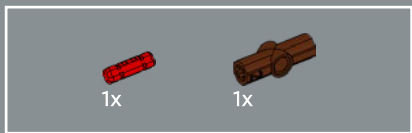

622

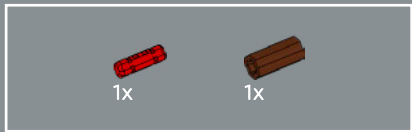
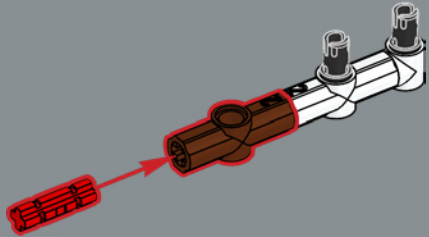

623

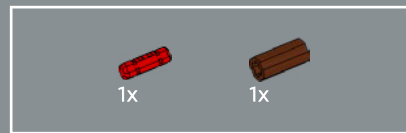
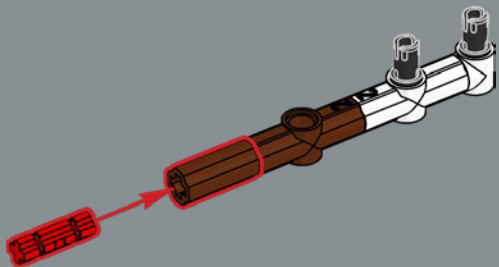

624

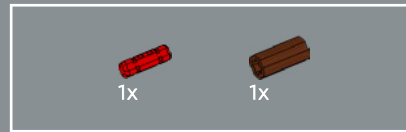
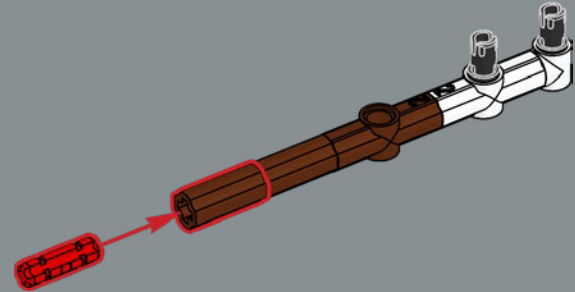

625

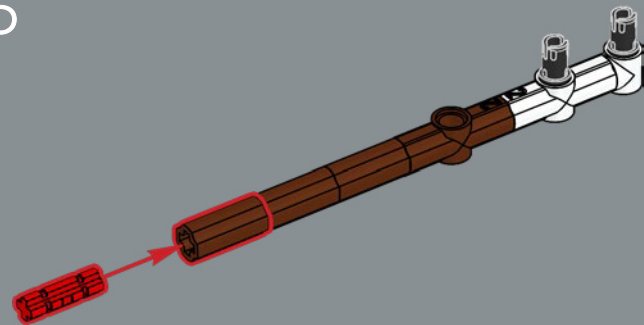

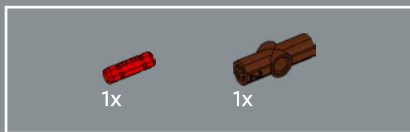

626

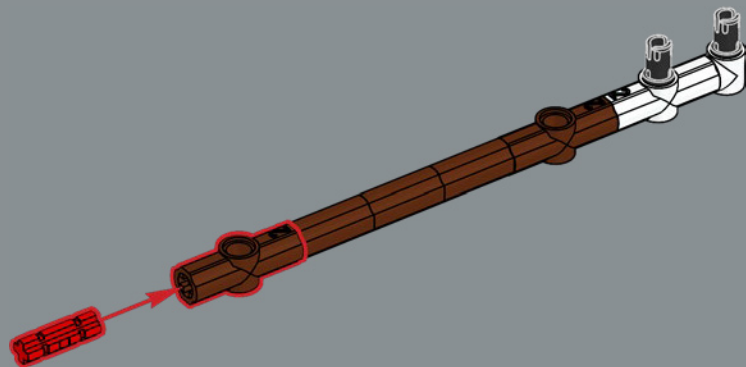

627

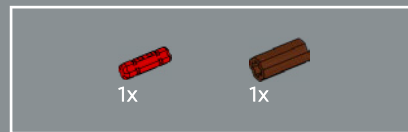
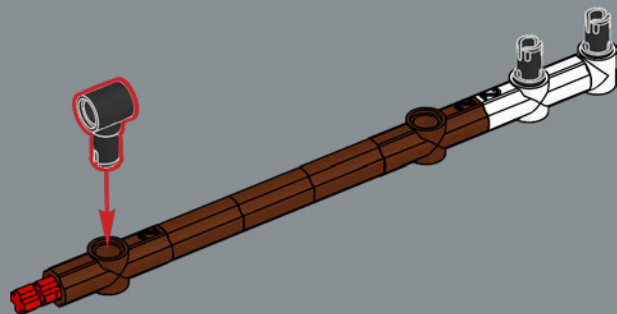

628

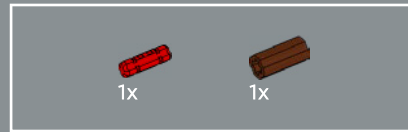
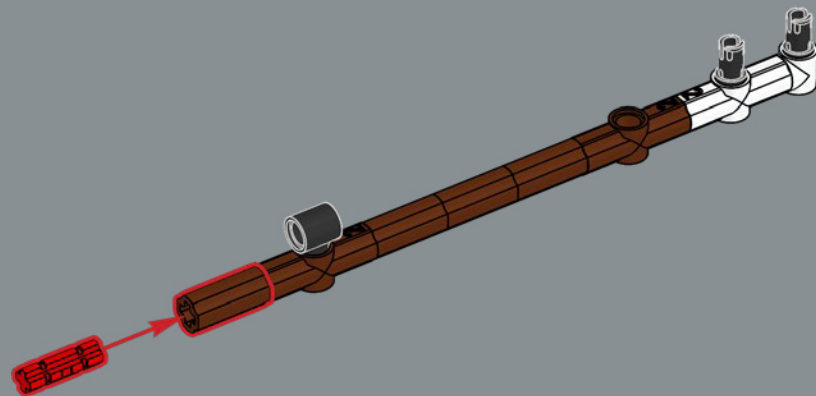

629

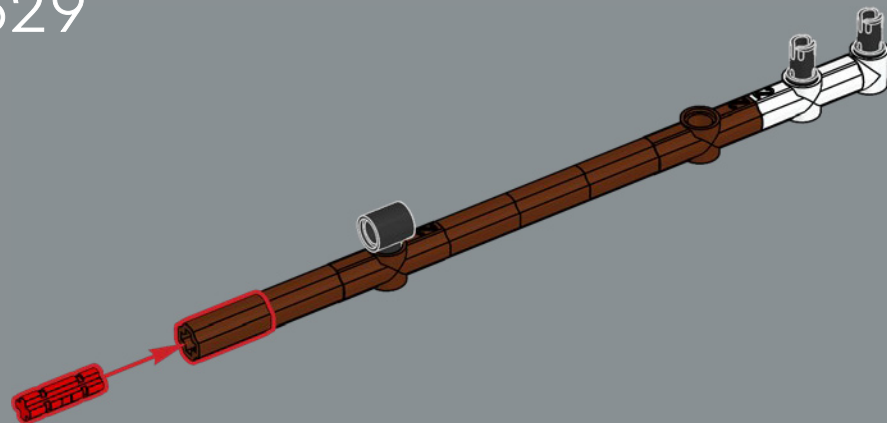

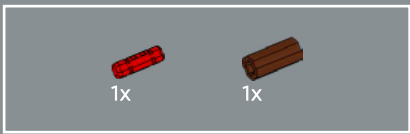

630

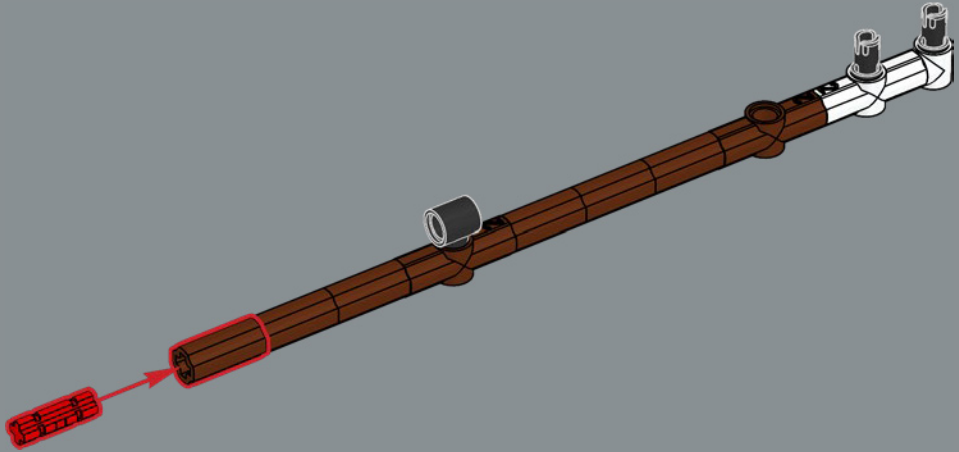

631

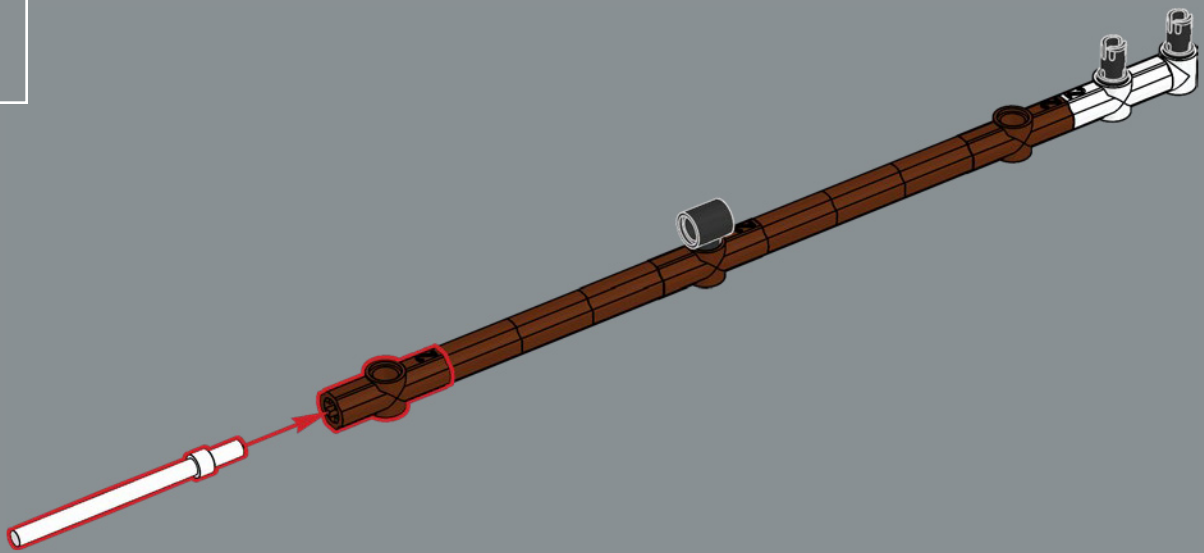



632

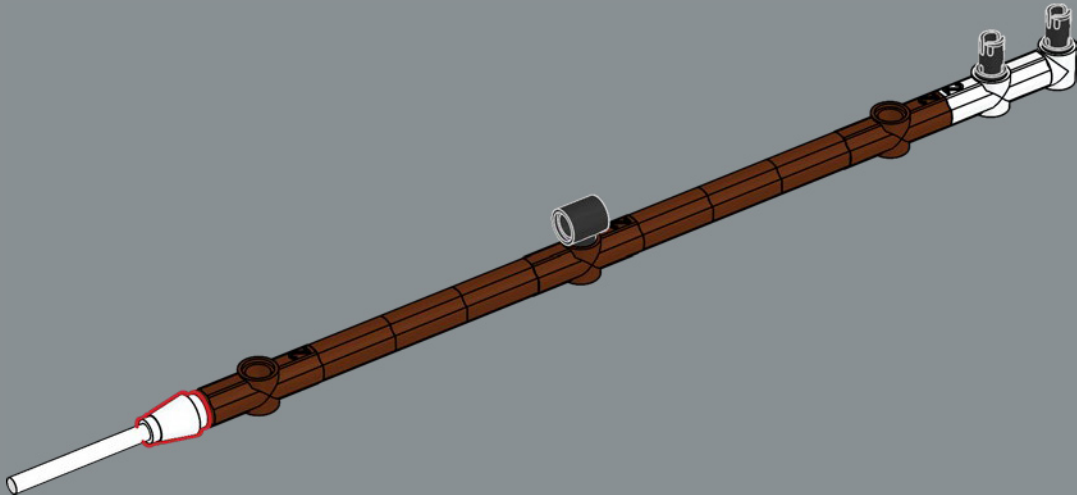

633

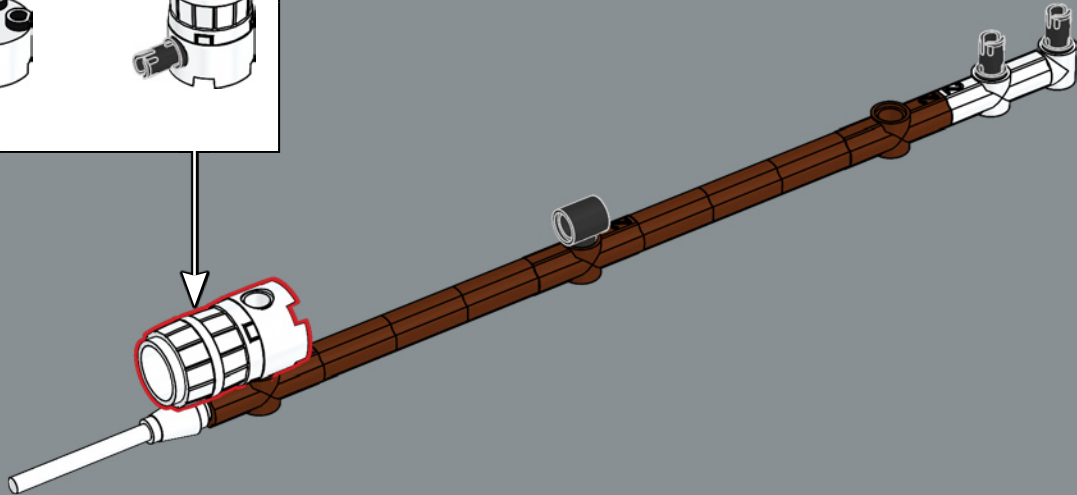
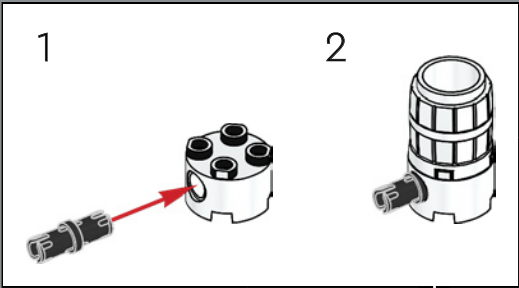

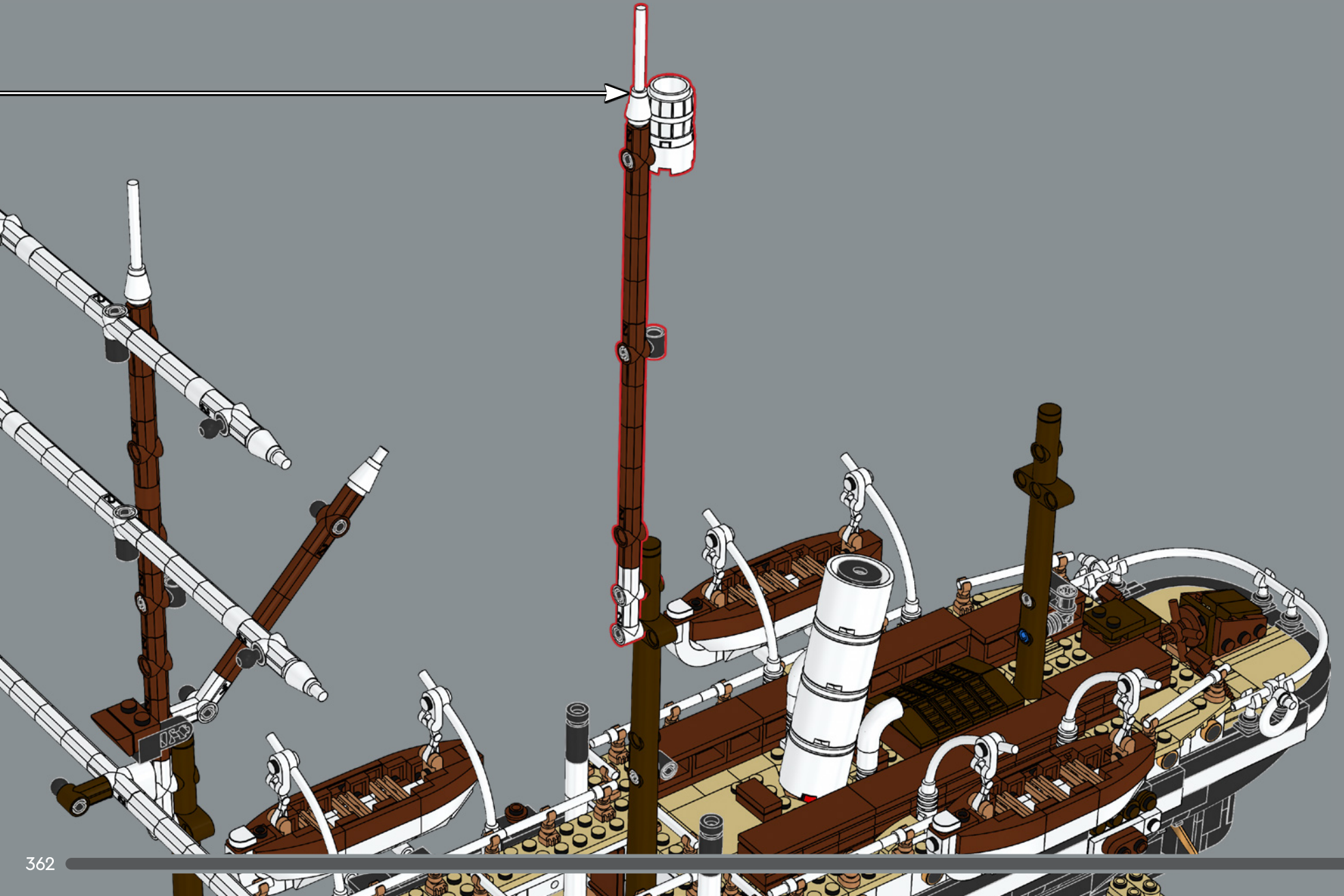

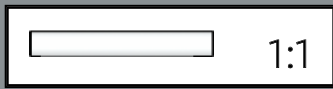
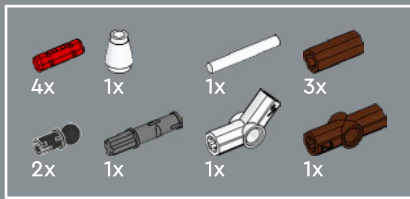

635

1

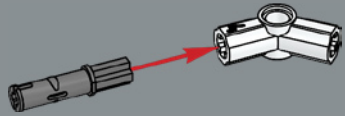

2

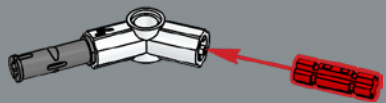

3

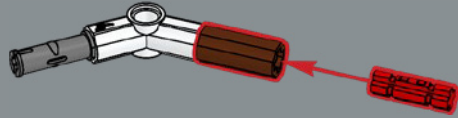

4



5

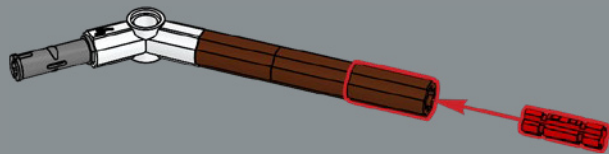

6

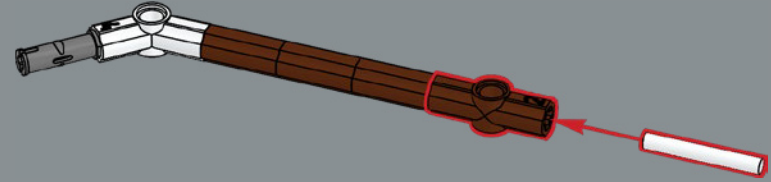

7

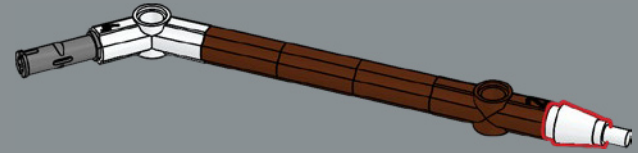

8

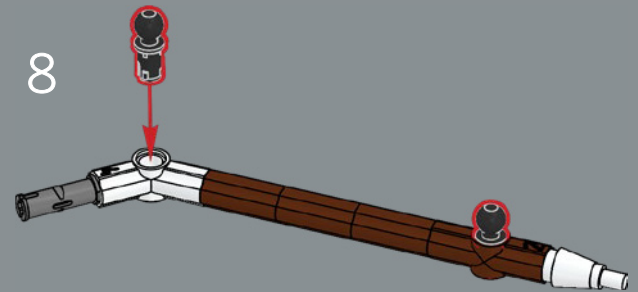





636

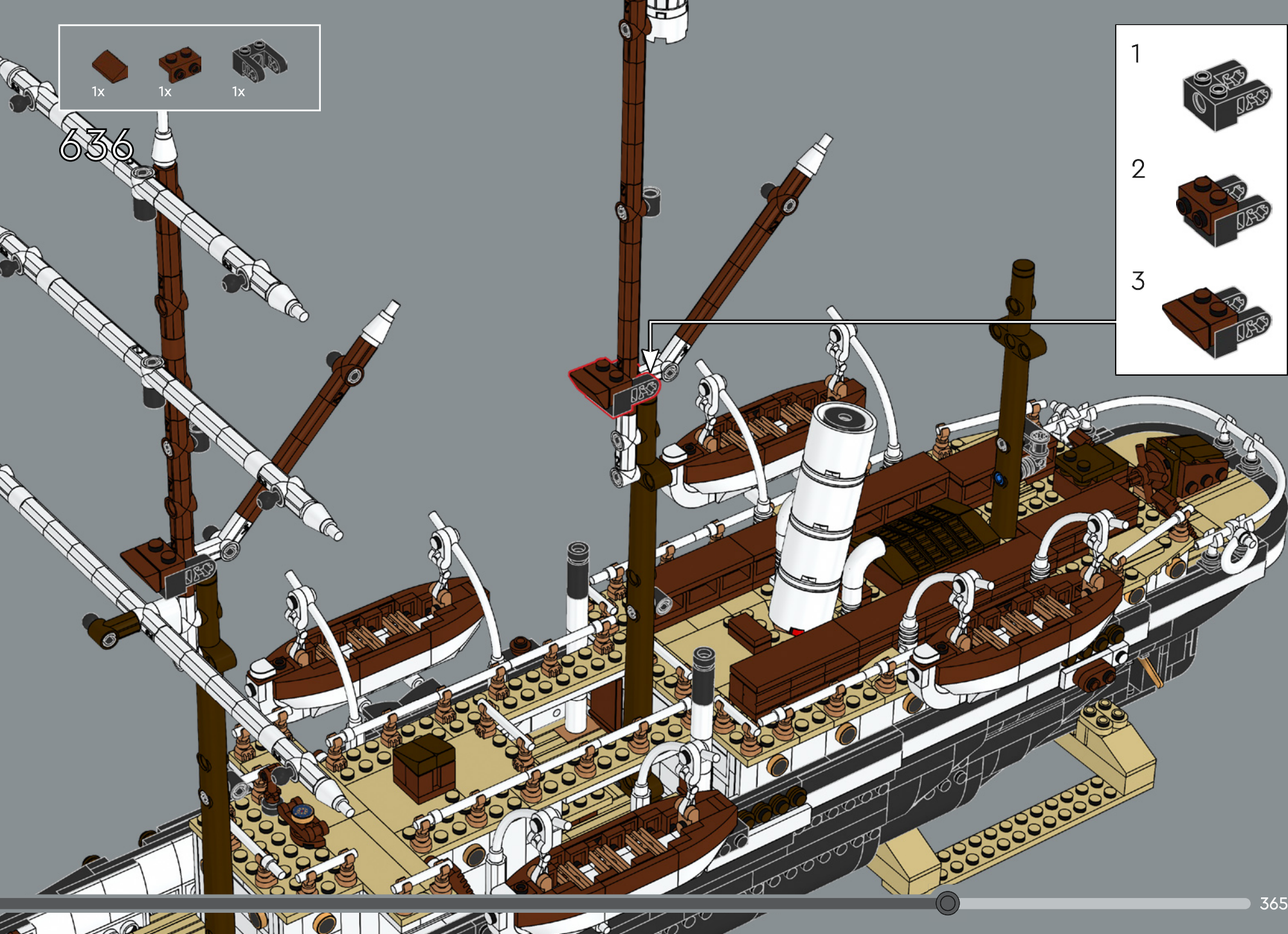
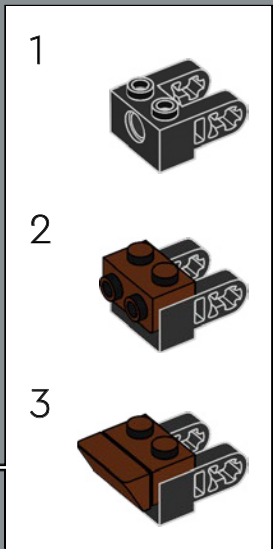

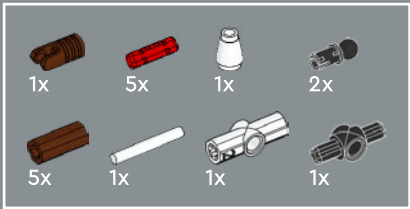

637

1

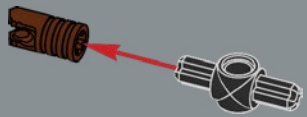

2

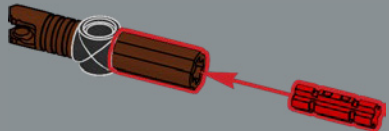

3

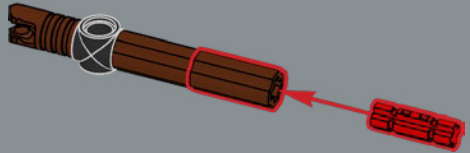

4

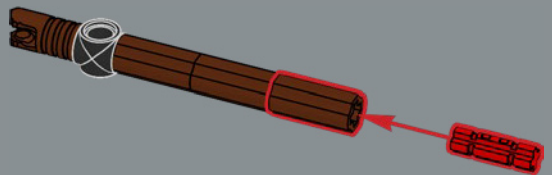

5

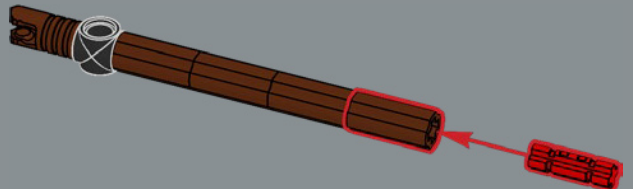

6

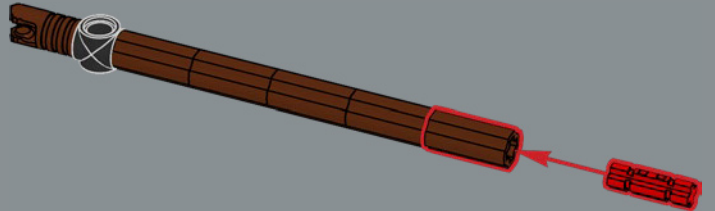

7

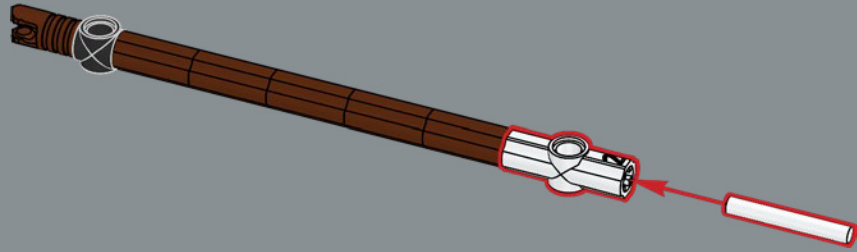

8

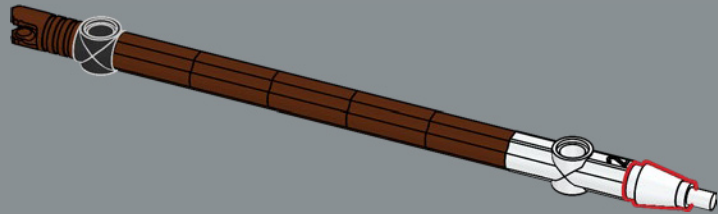

9

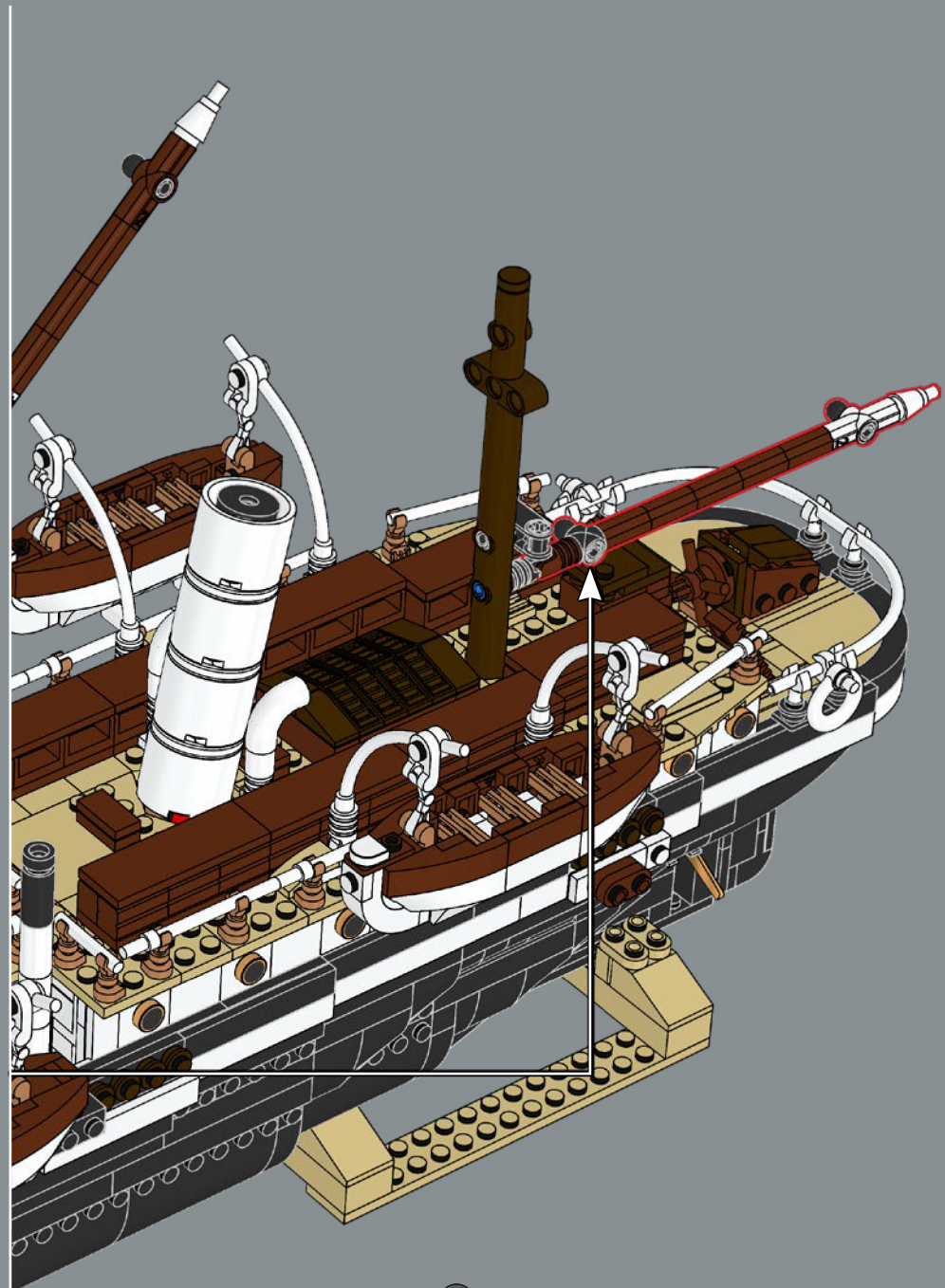
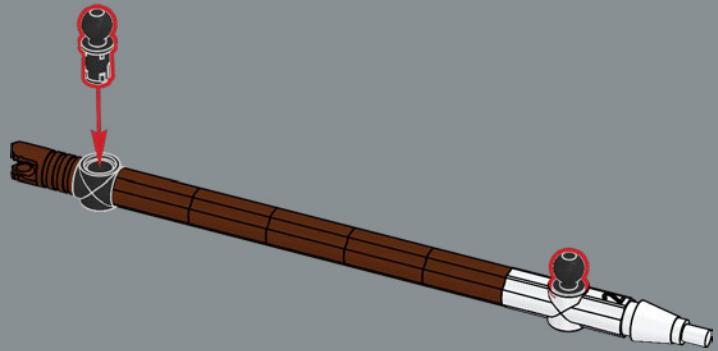

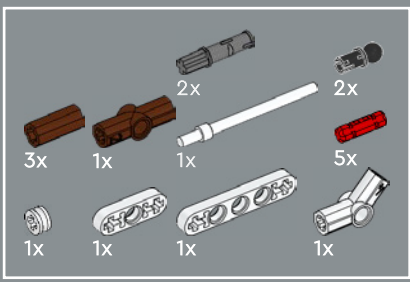

638

1

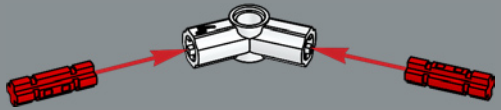

2

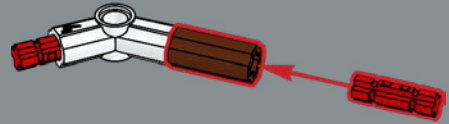

3

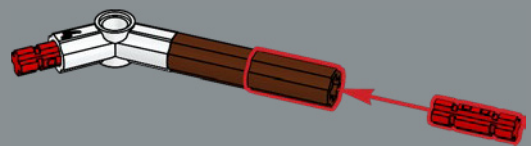

4

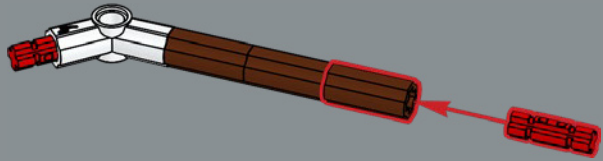

5

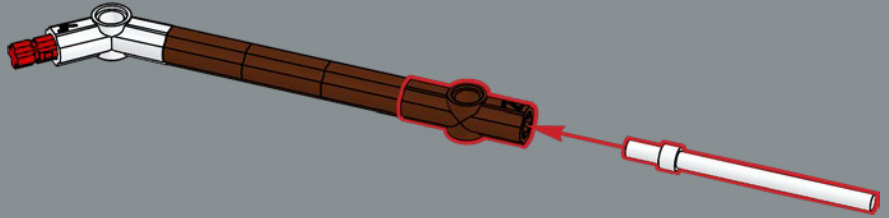

6

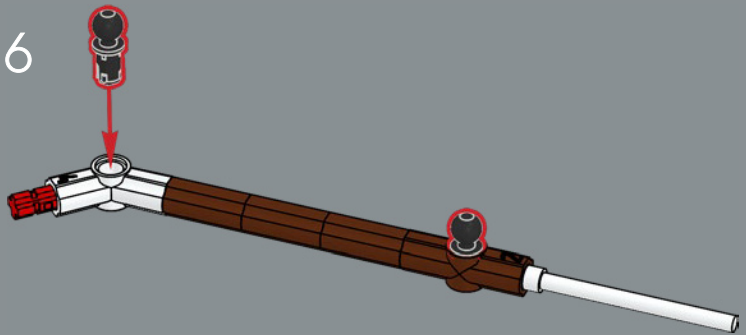

7

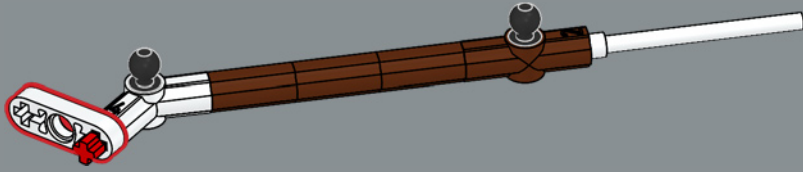

9

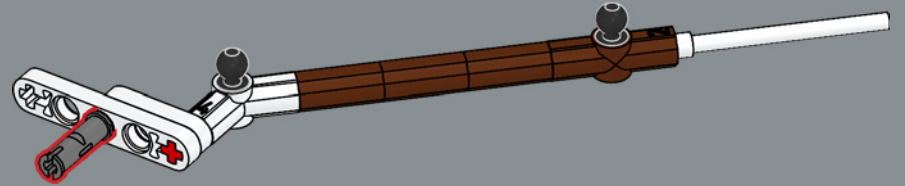

8

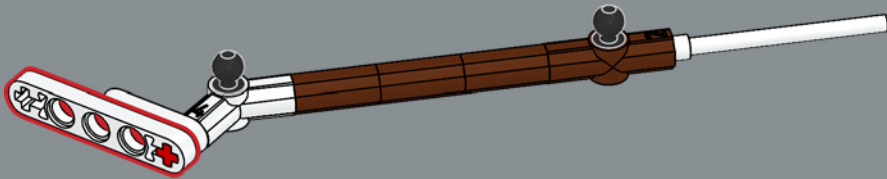

10

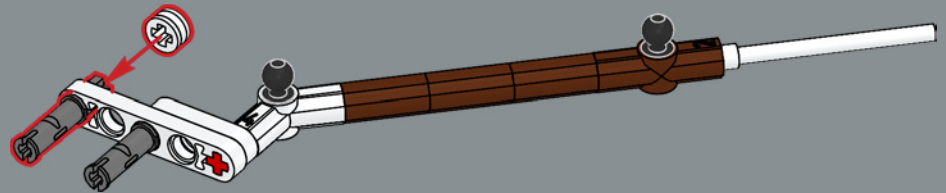

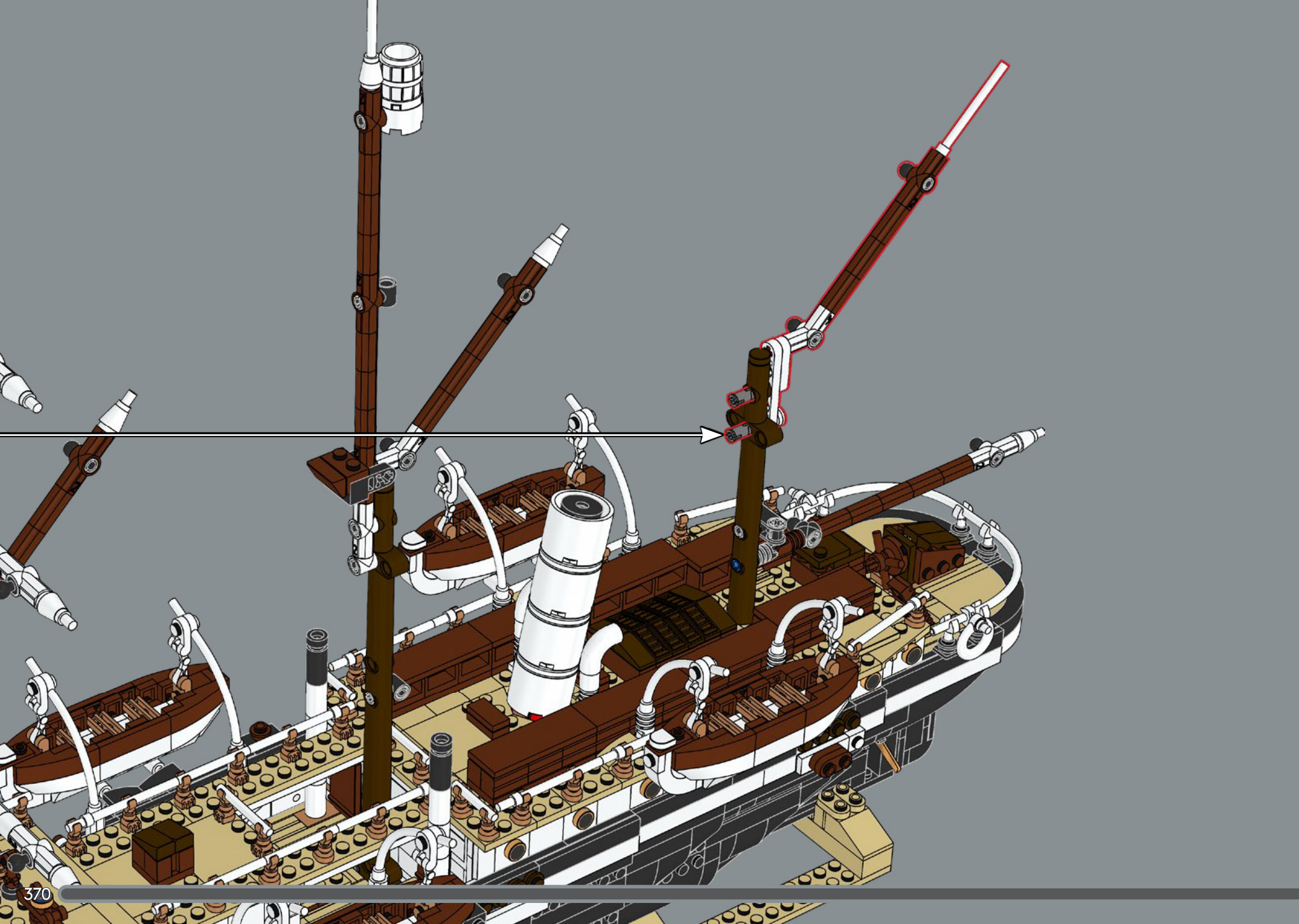

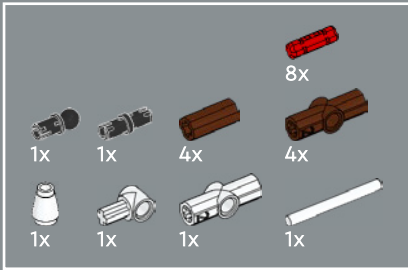
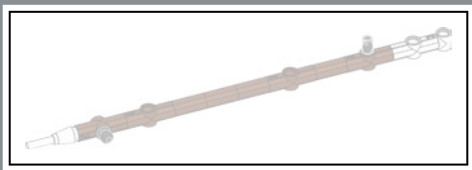

639

1

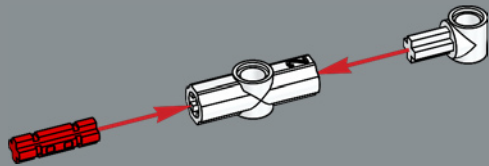

2

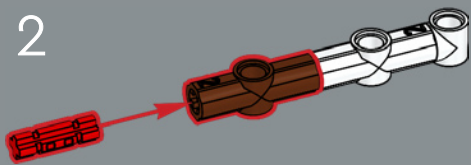

3

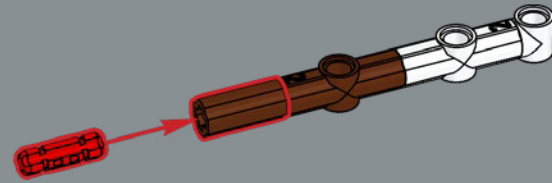

4

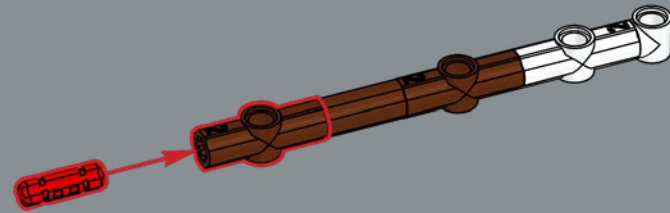

5

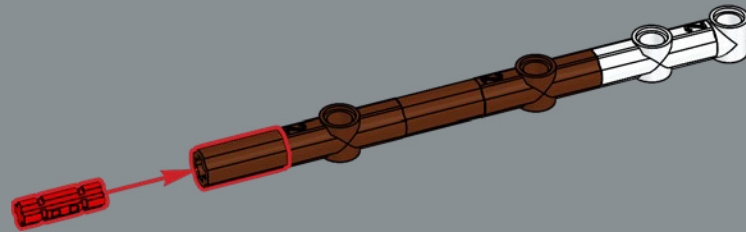

6

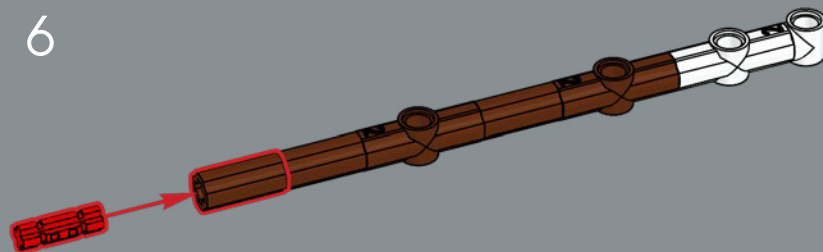

7

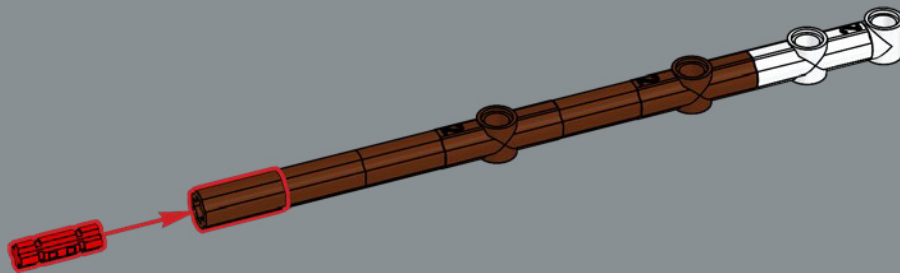

8

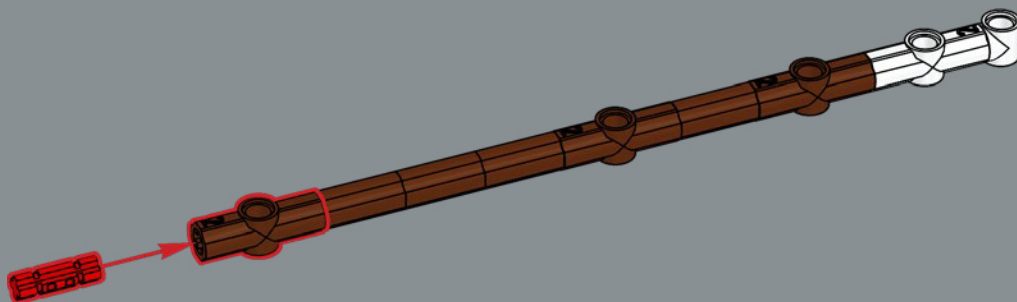

9

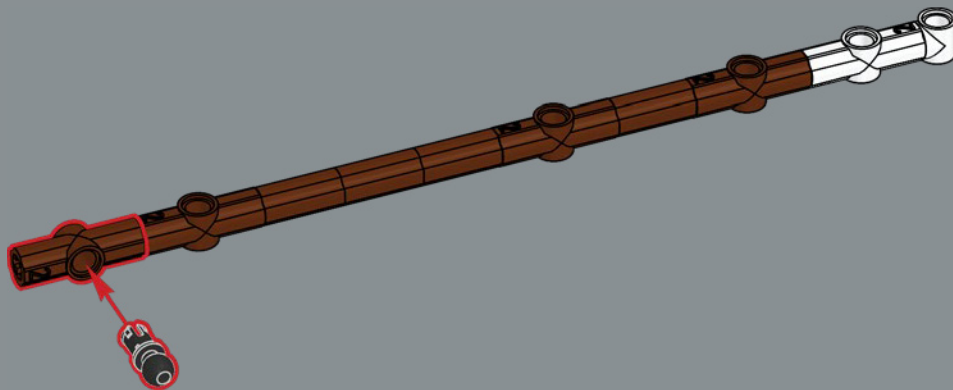

10

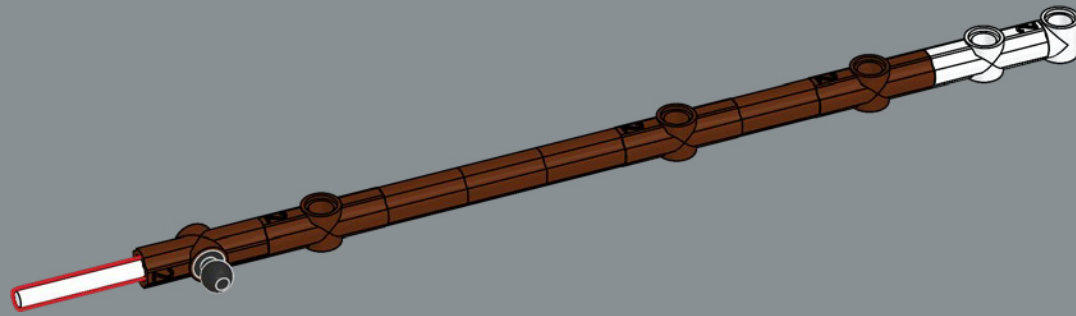

11

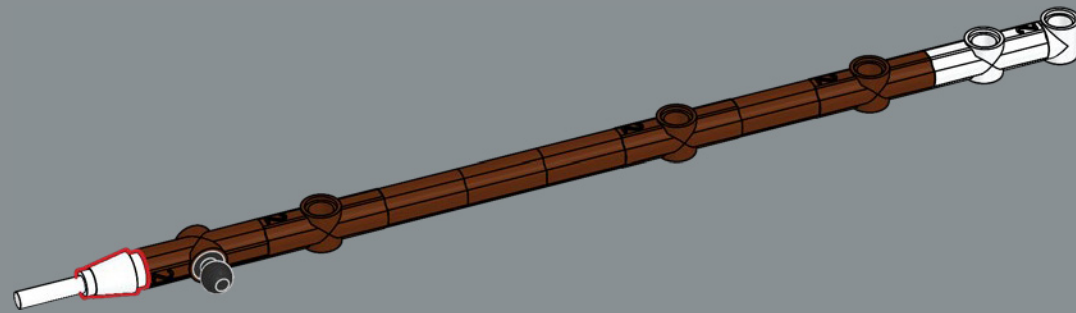

12

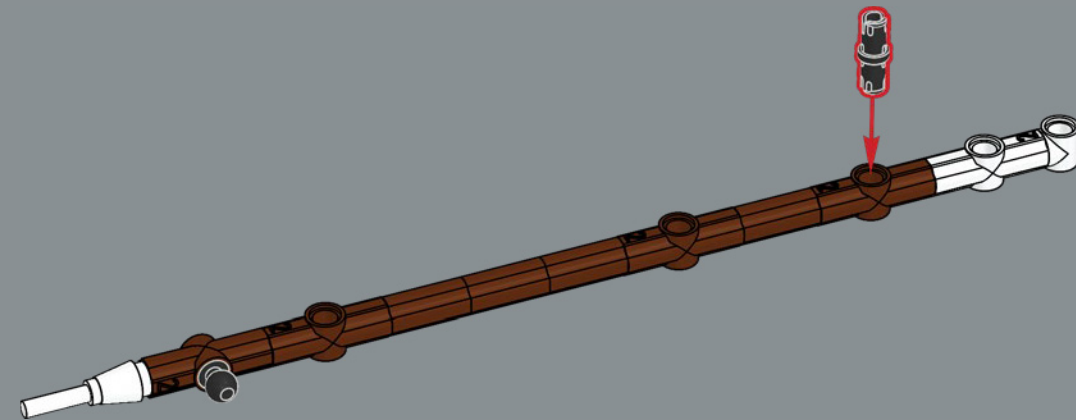

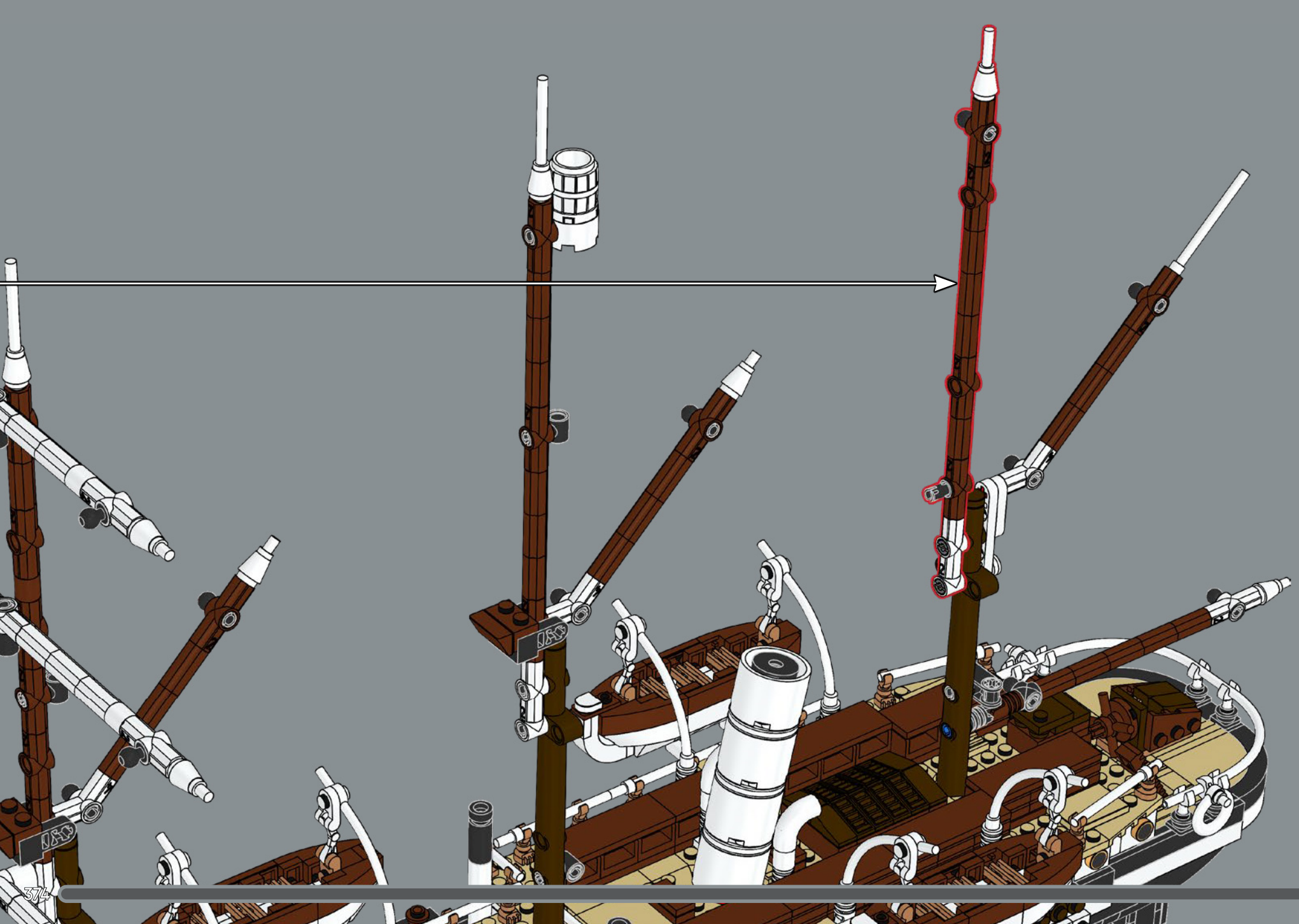



640

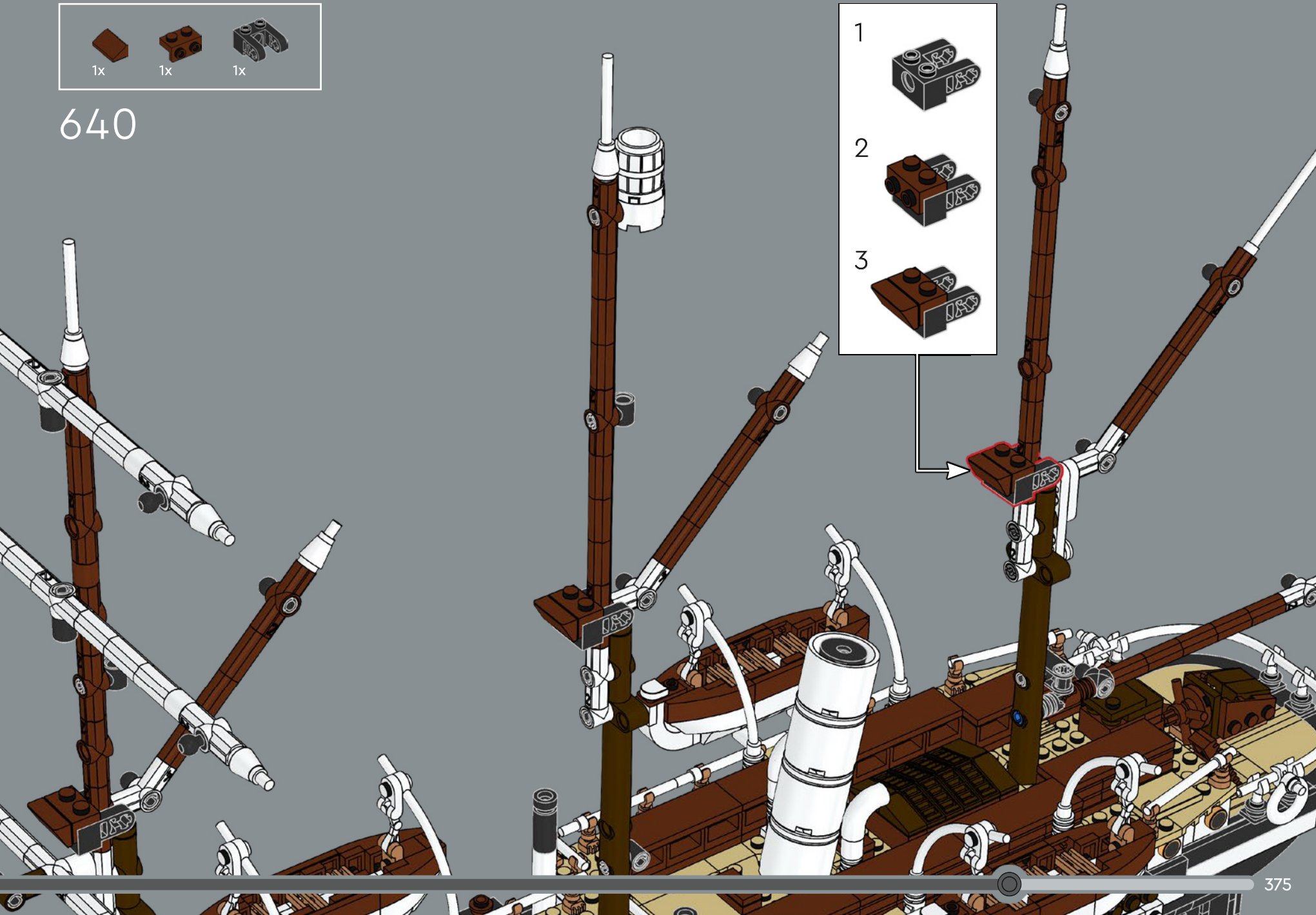
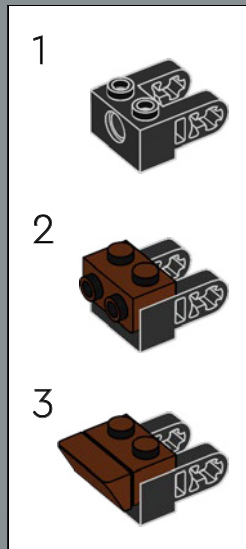

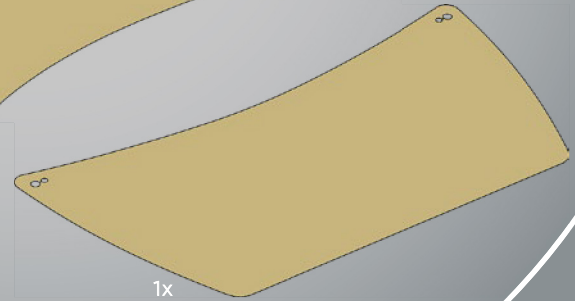
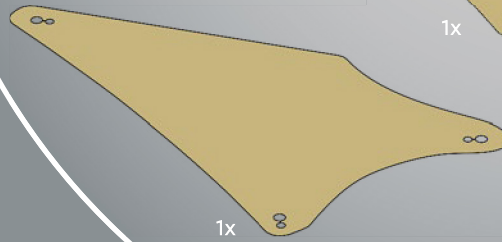
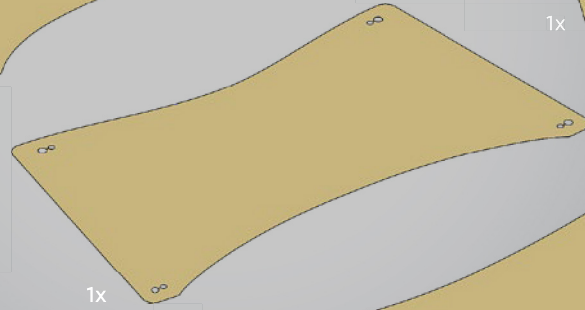
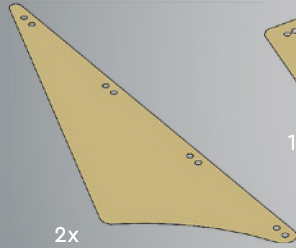
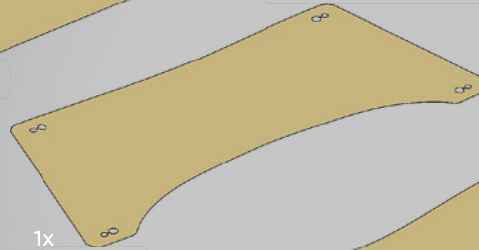
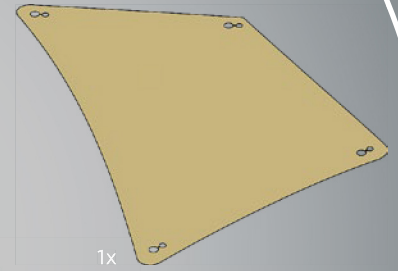
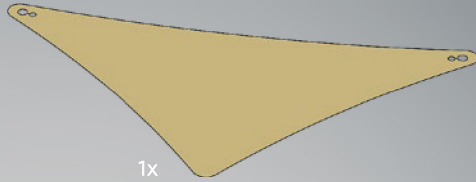
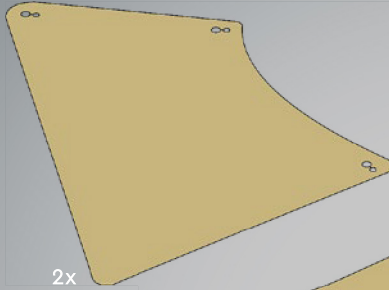
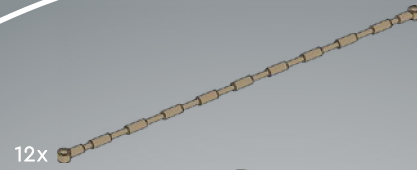
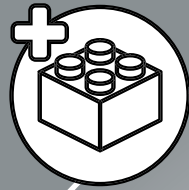



641

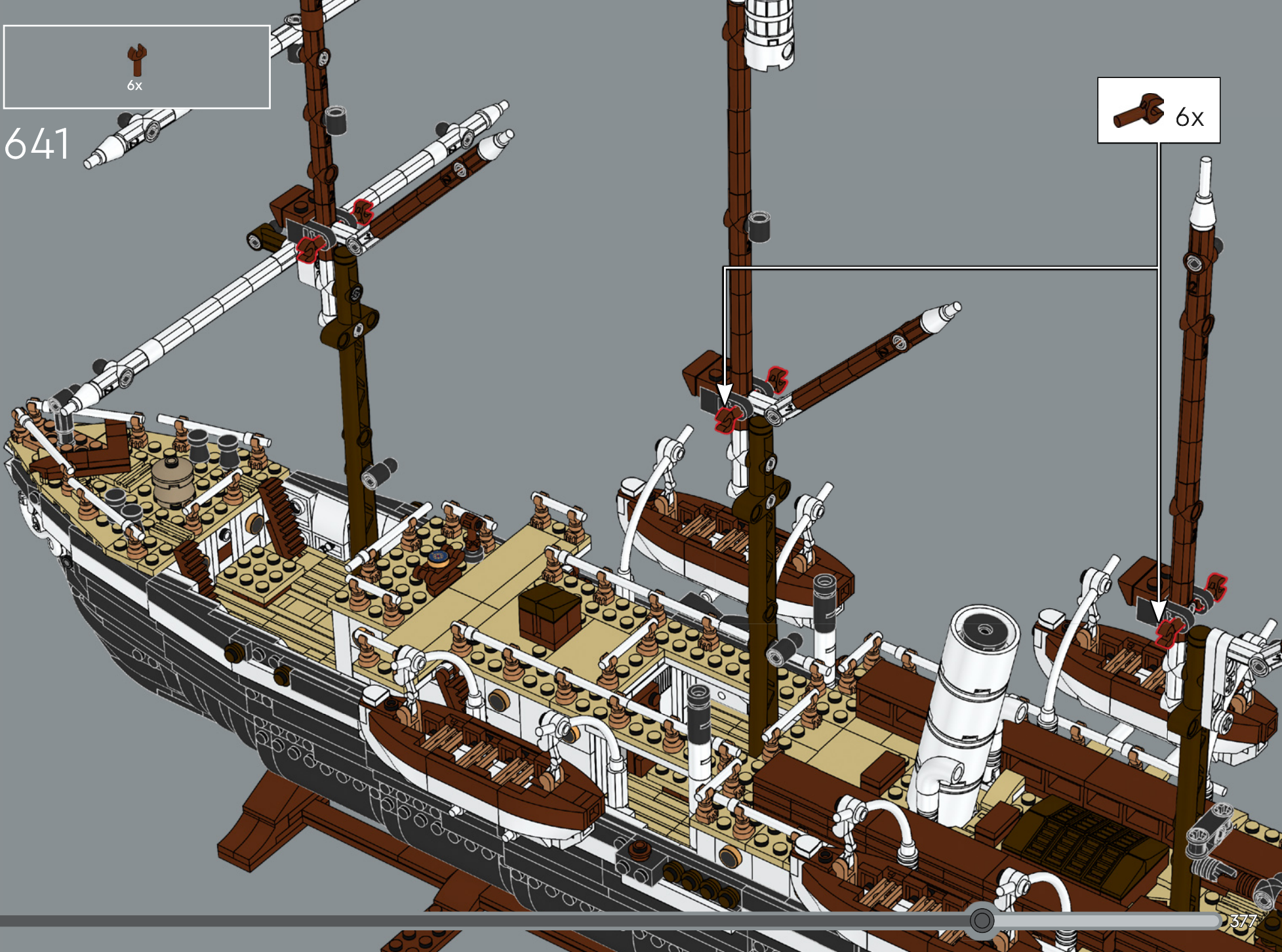

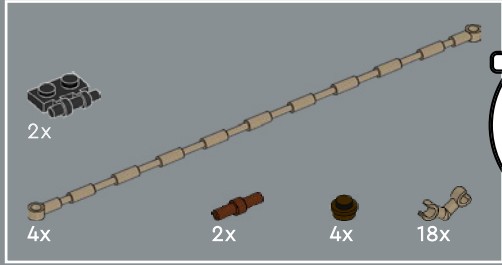
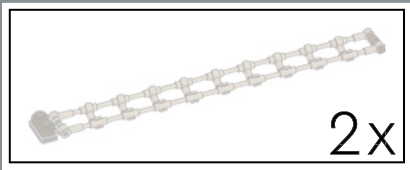

642

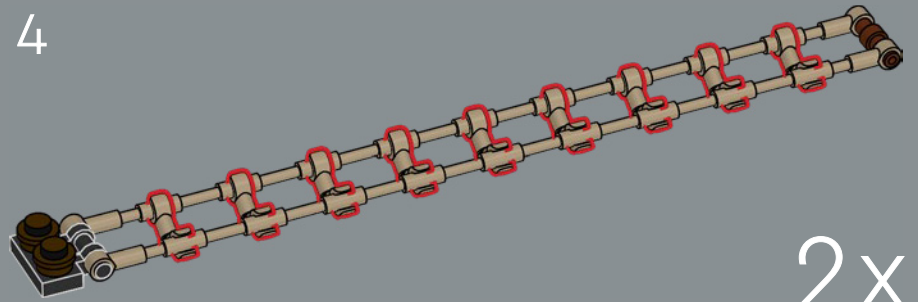
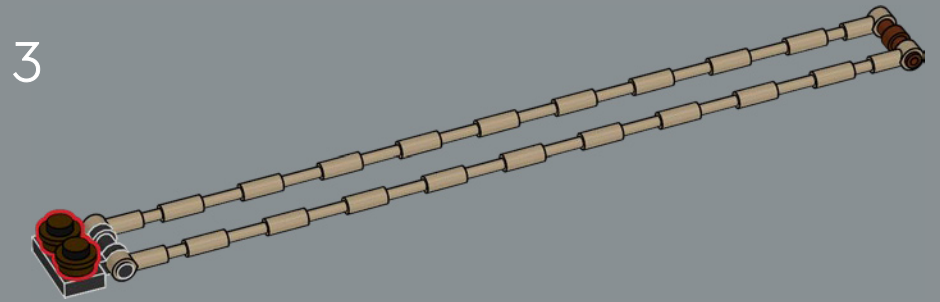
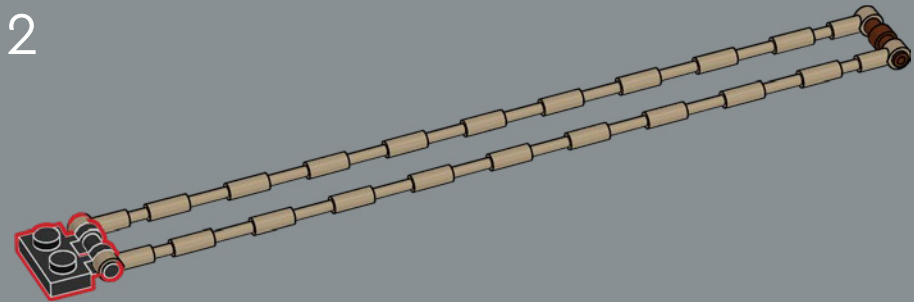
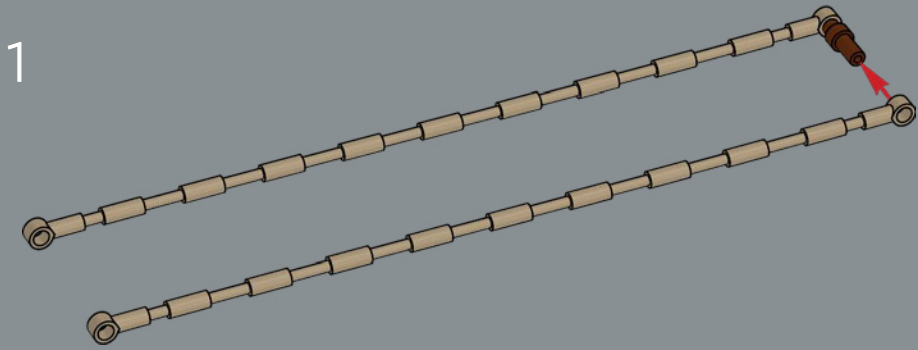



A las escalas de cabo se les dio un tono marrón ligeramente más oscuro para que su material se distinguiera de la mayor parte de la estructura del barco, de color similar a la madera.

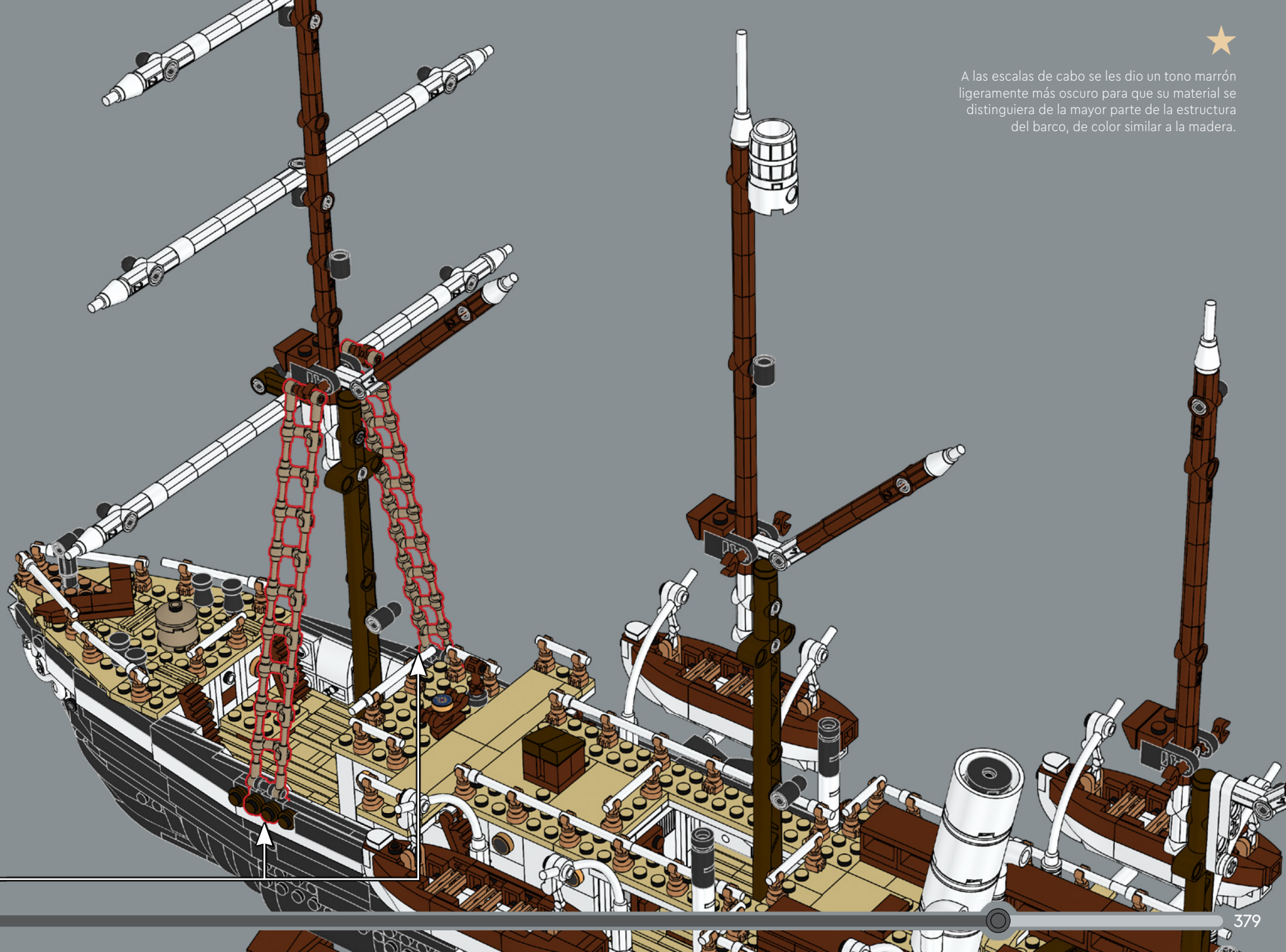

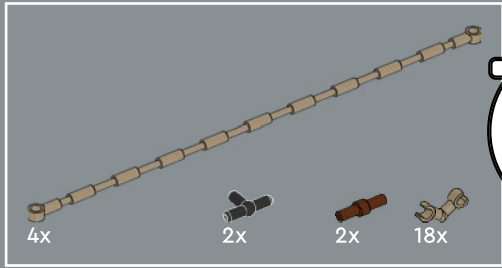
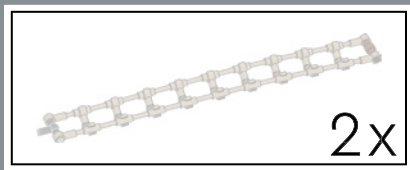

643

1

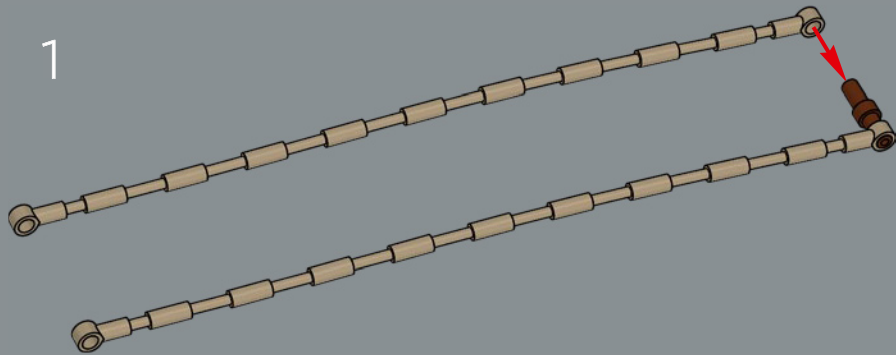

2

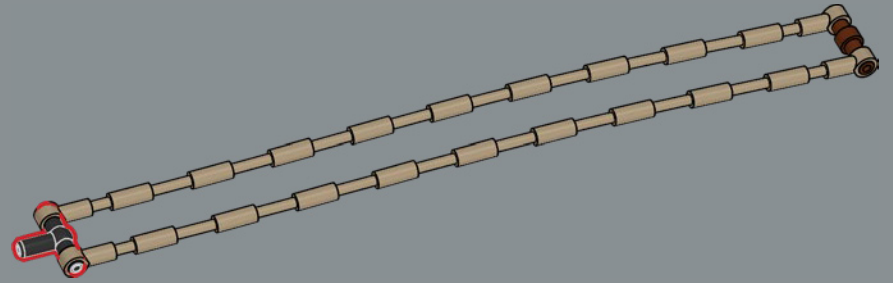

3

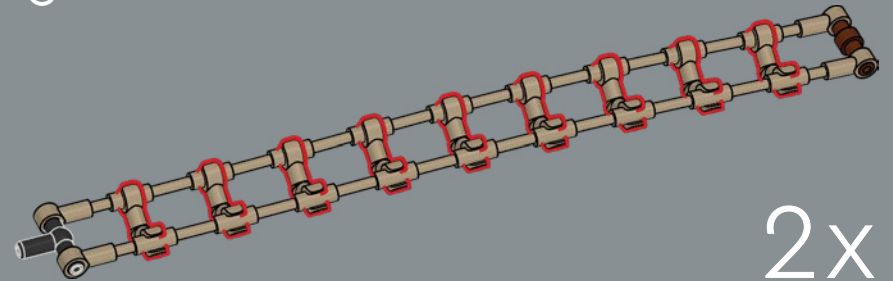

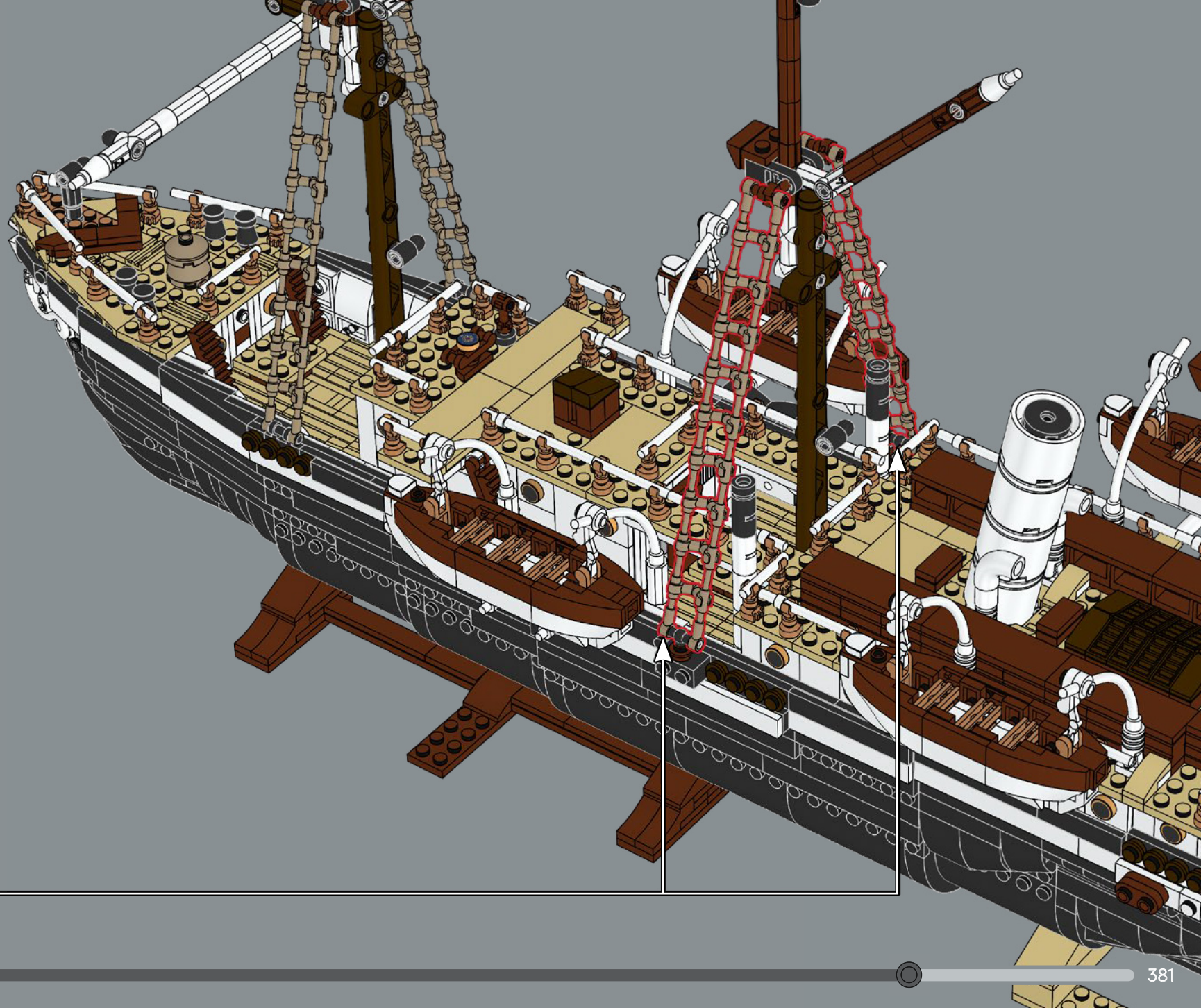

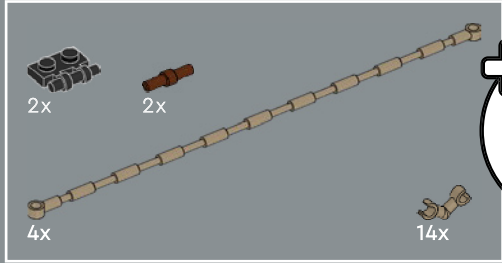
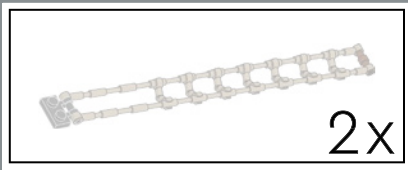

644

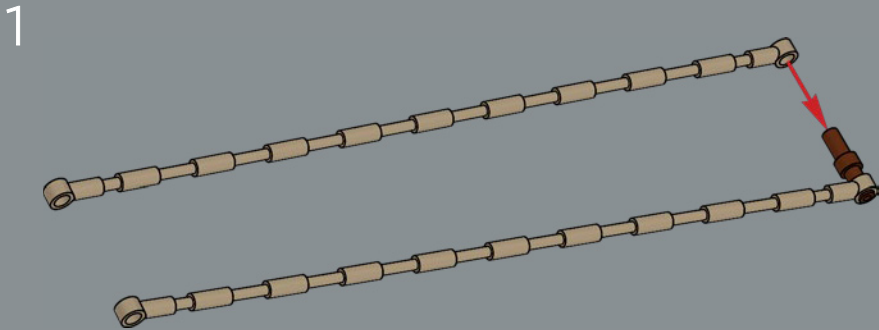

2

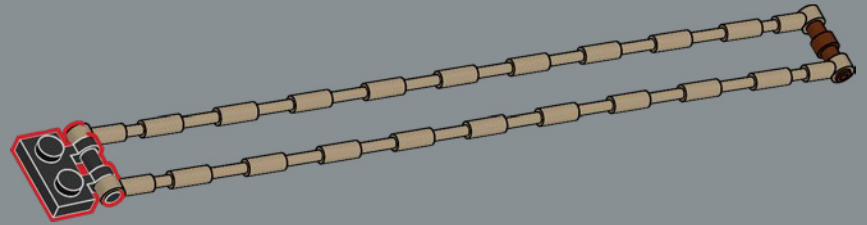

3

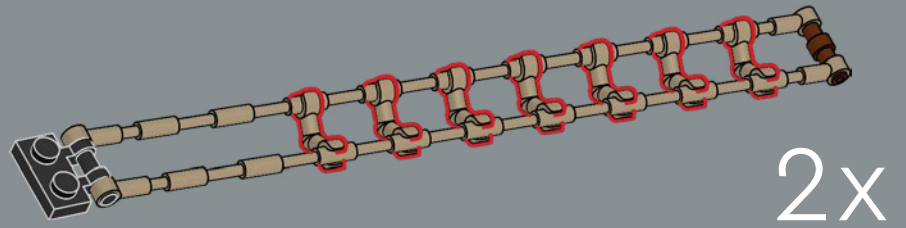

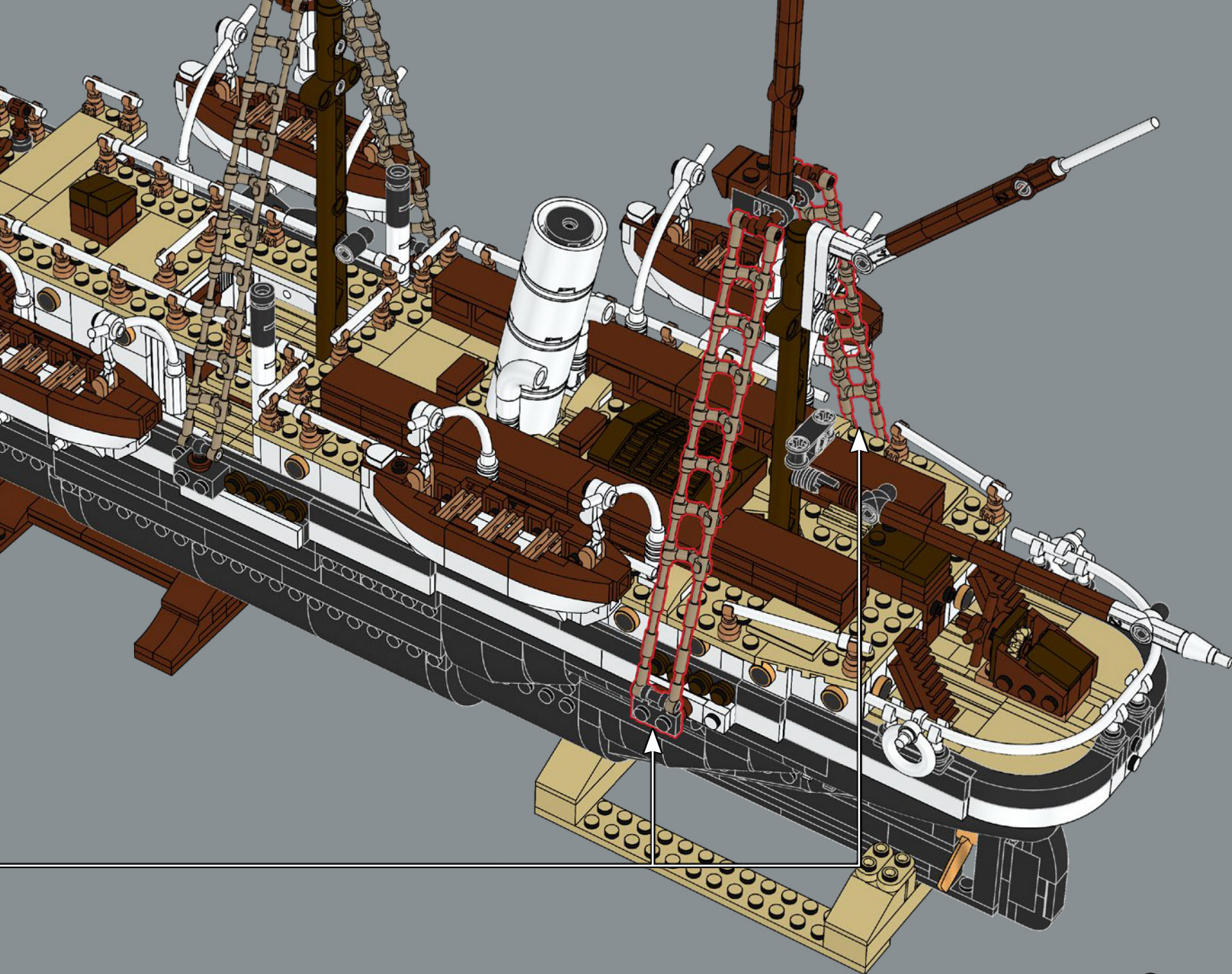



645



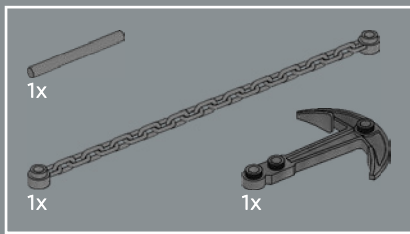

646

1

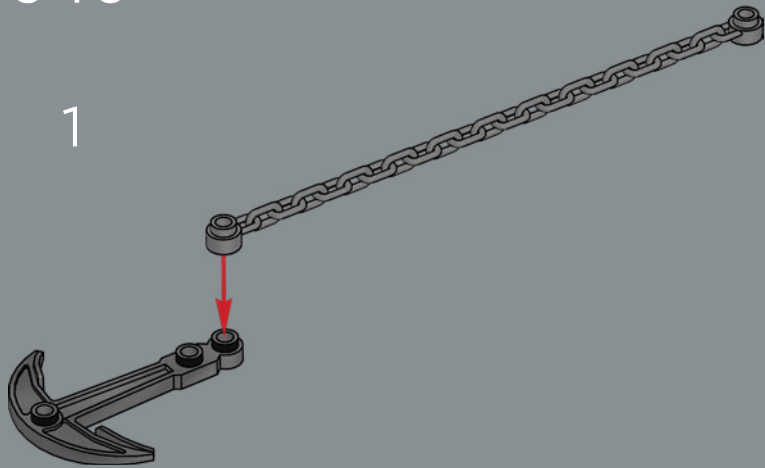

2

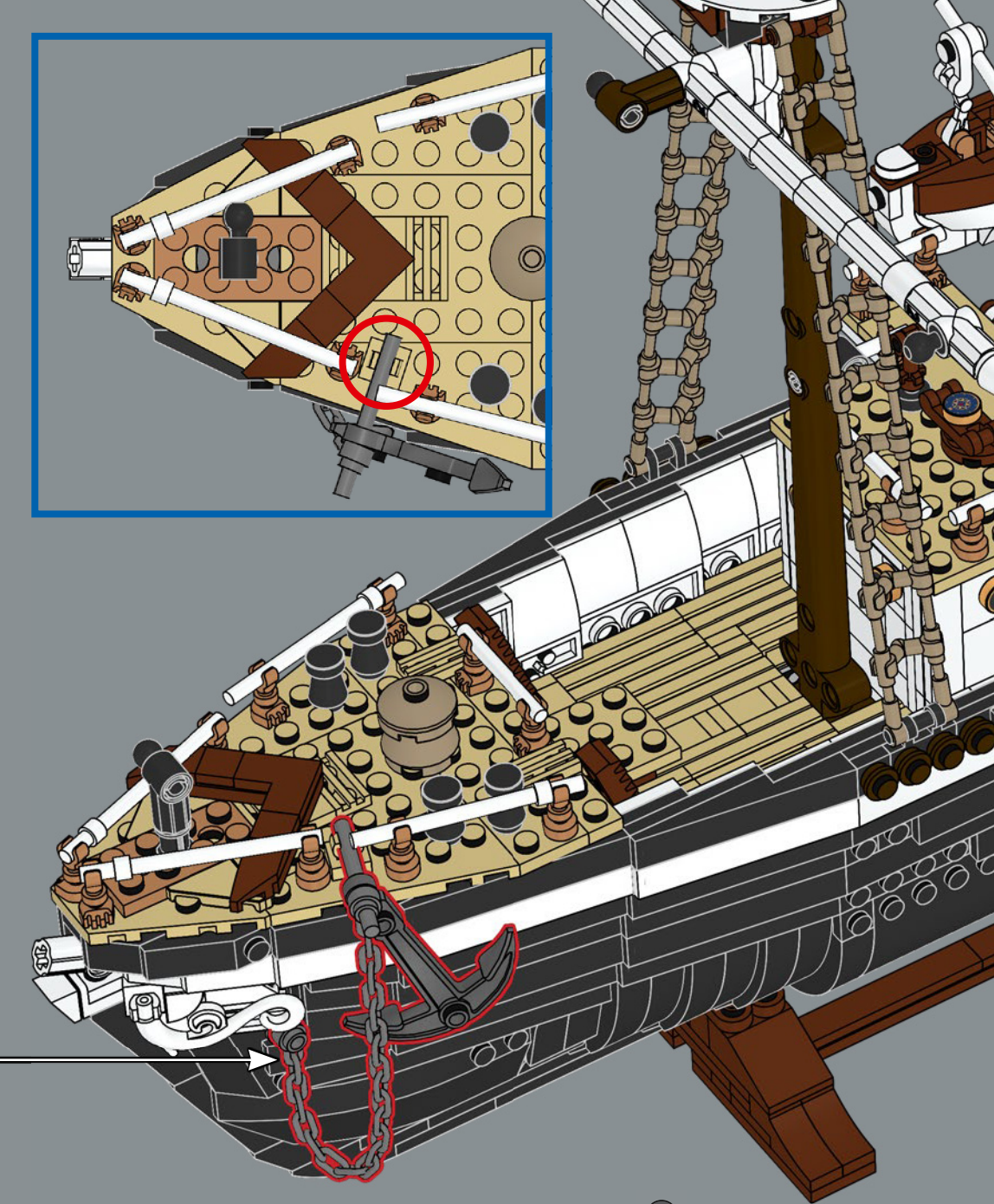
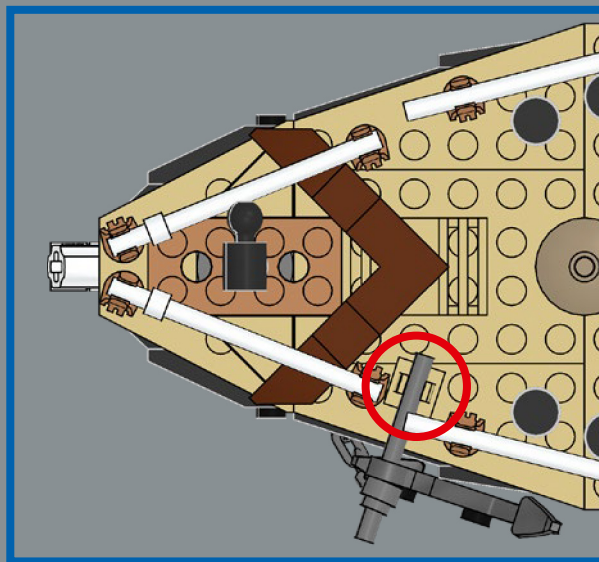
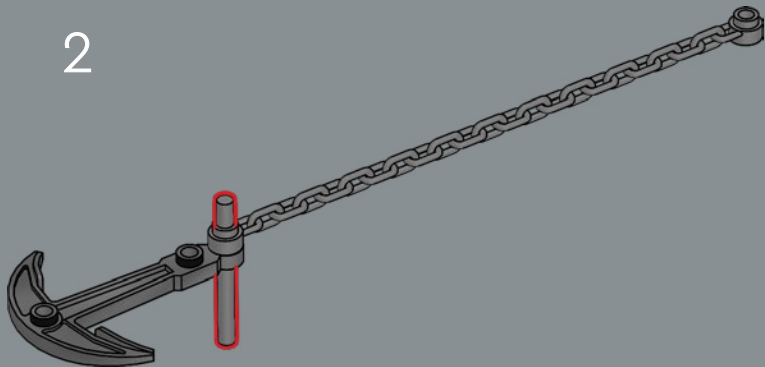

647

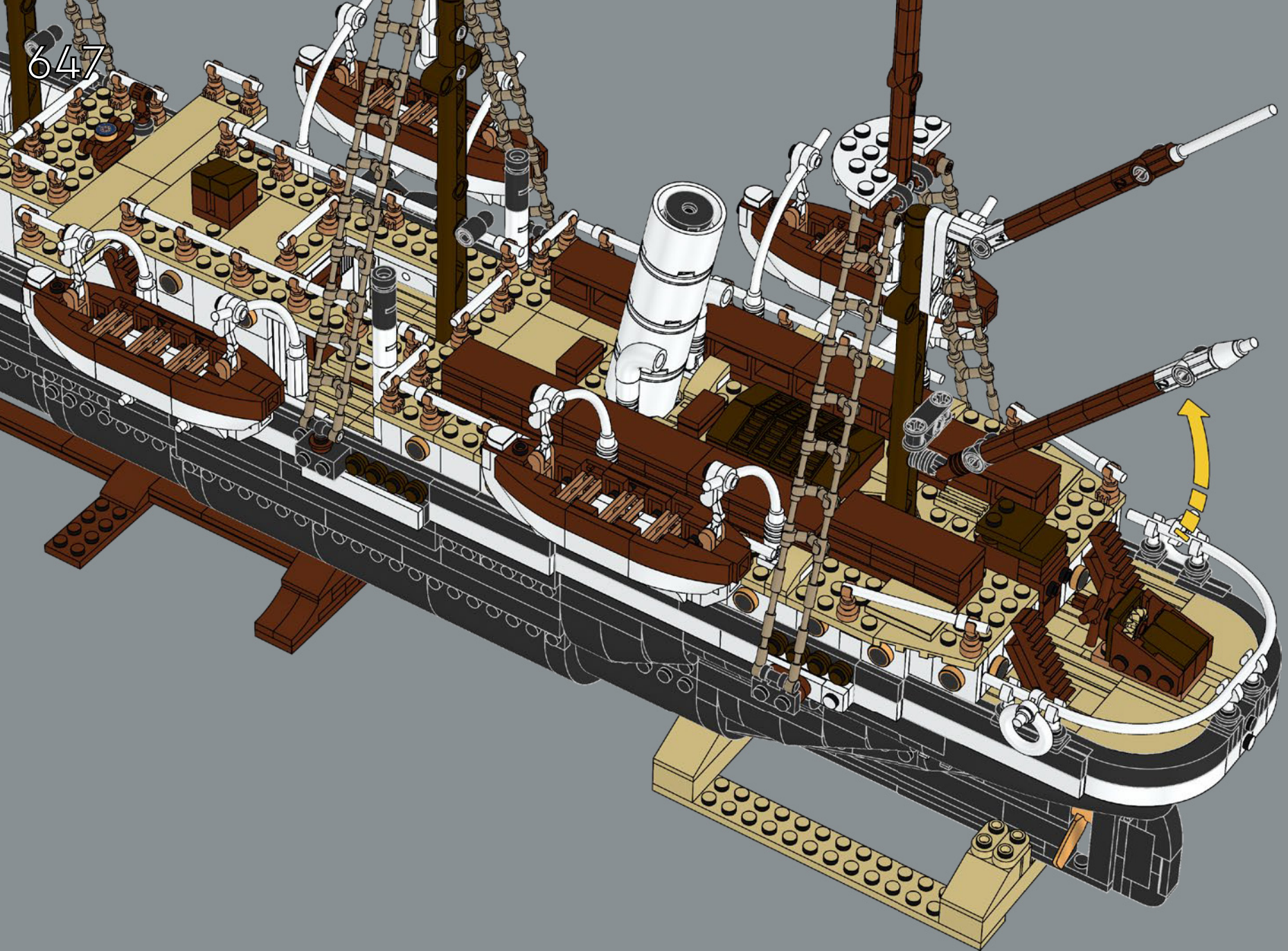

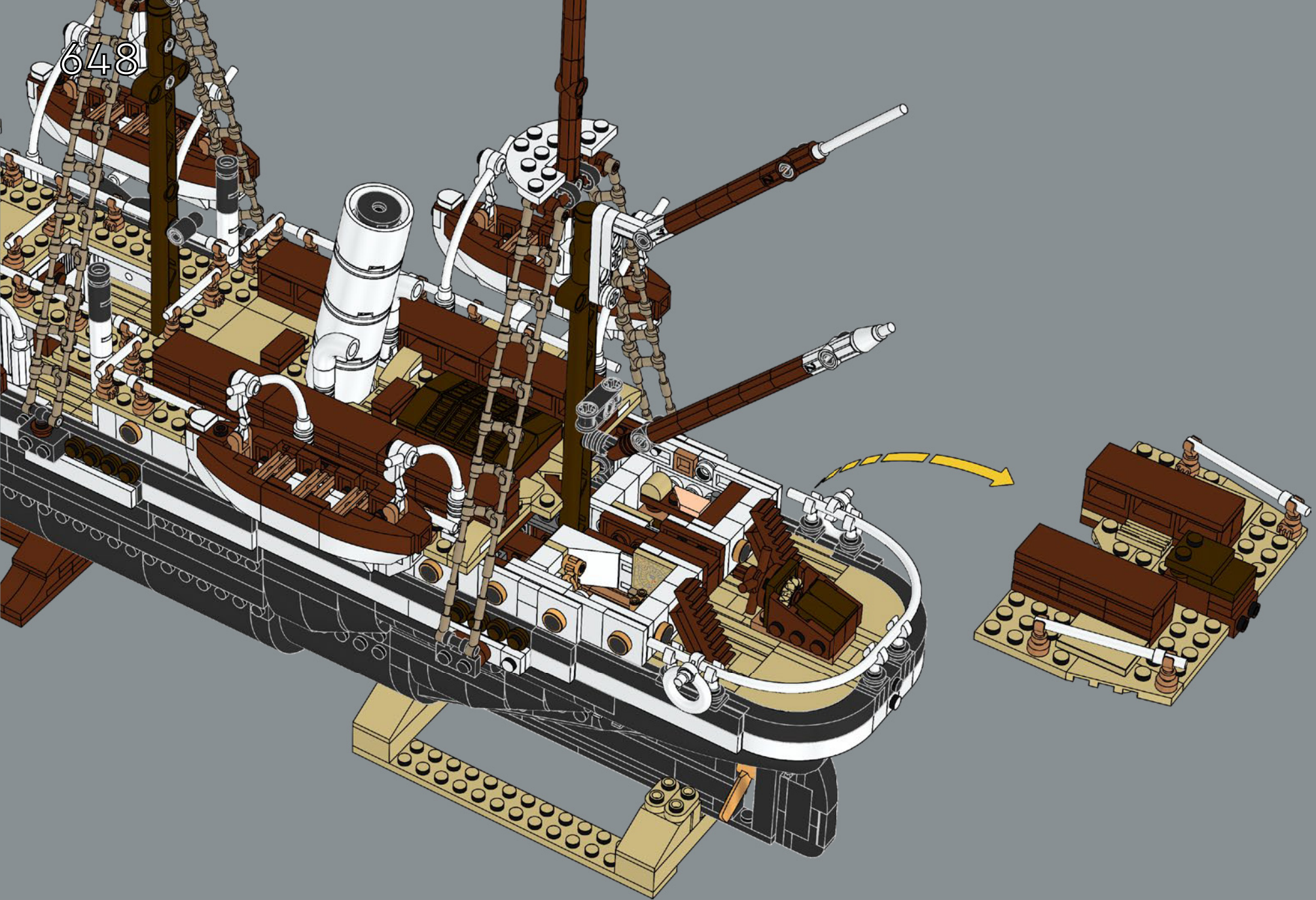

649

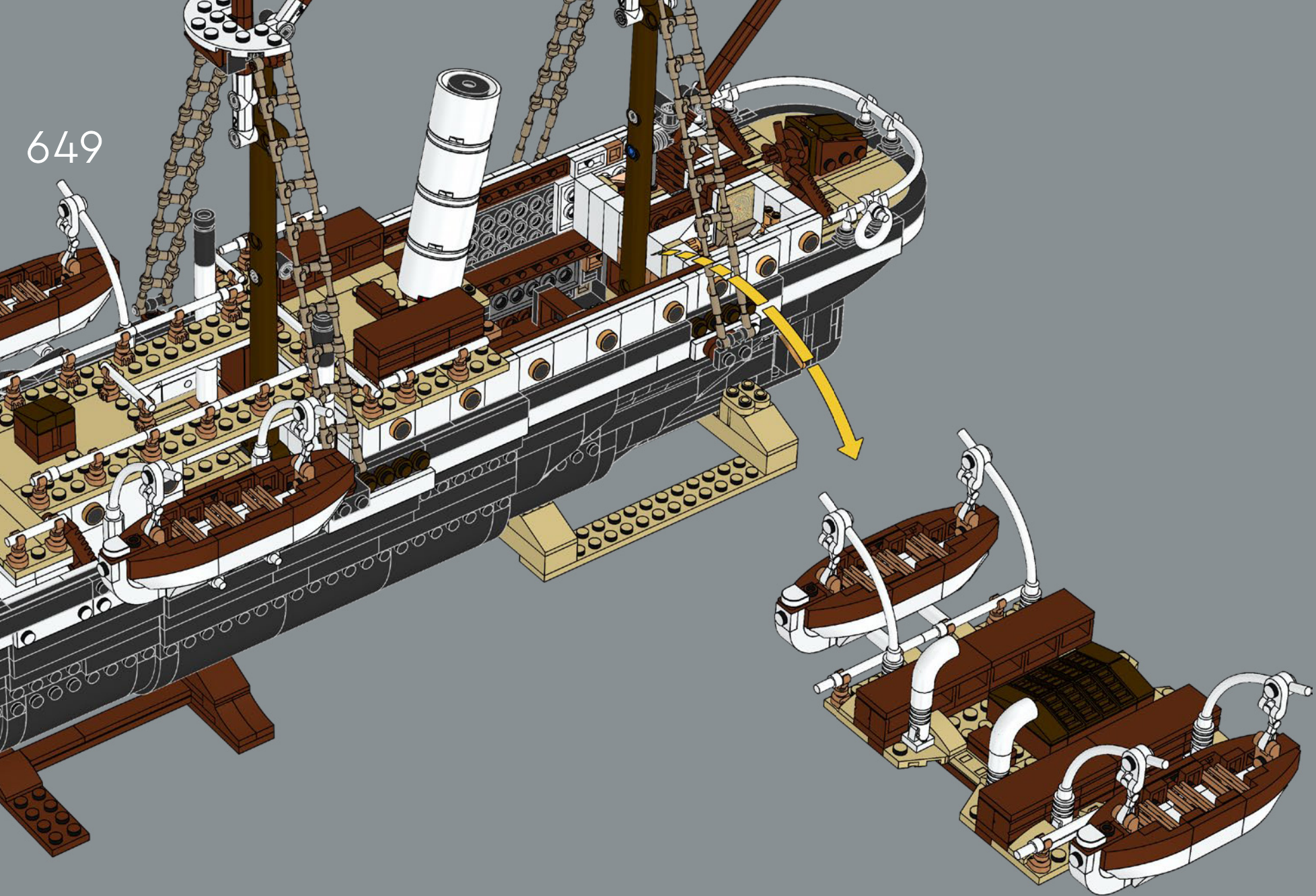

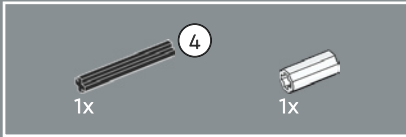
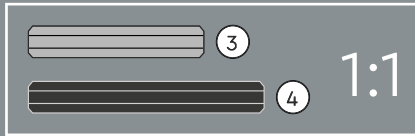
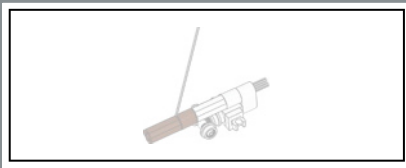

650

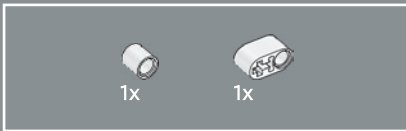
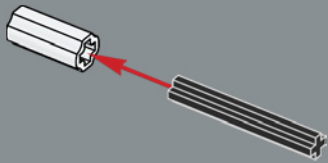

651

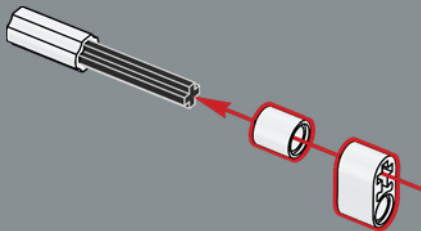

652

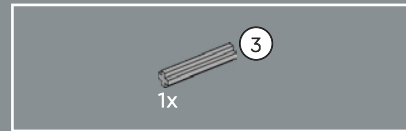
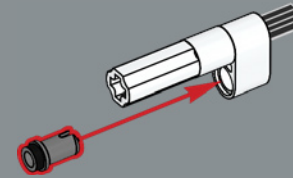

653

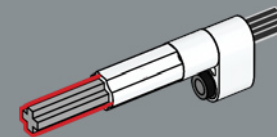

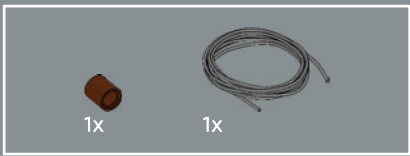

654

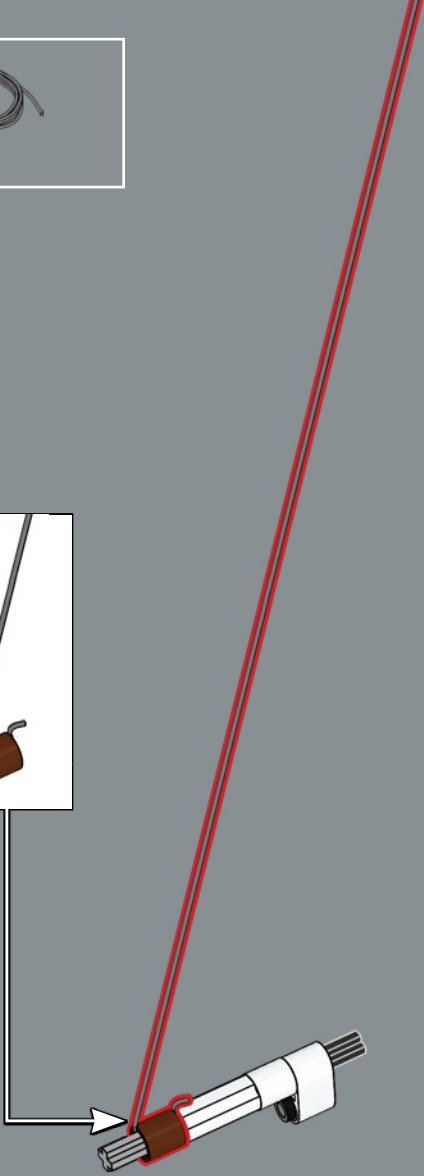
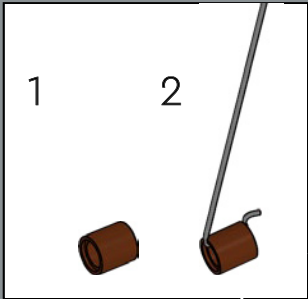

655

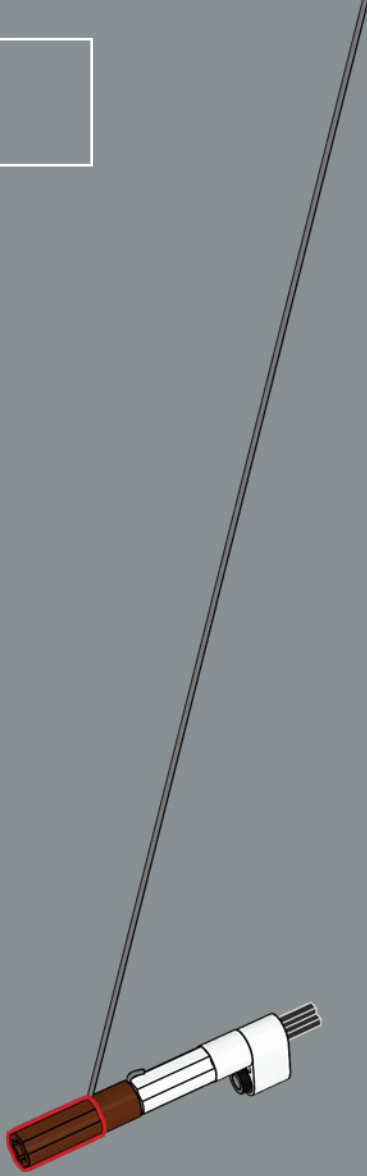

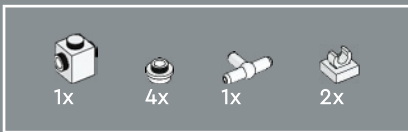

656

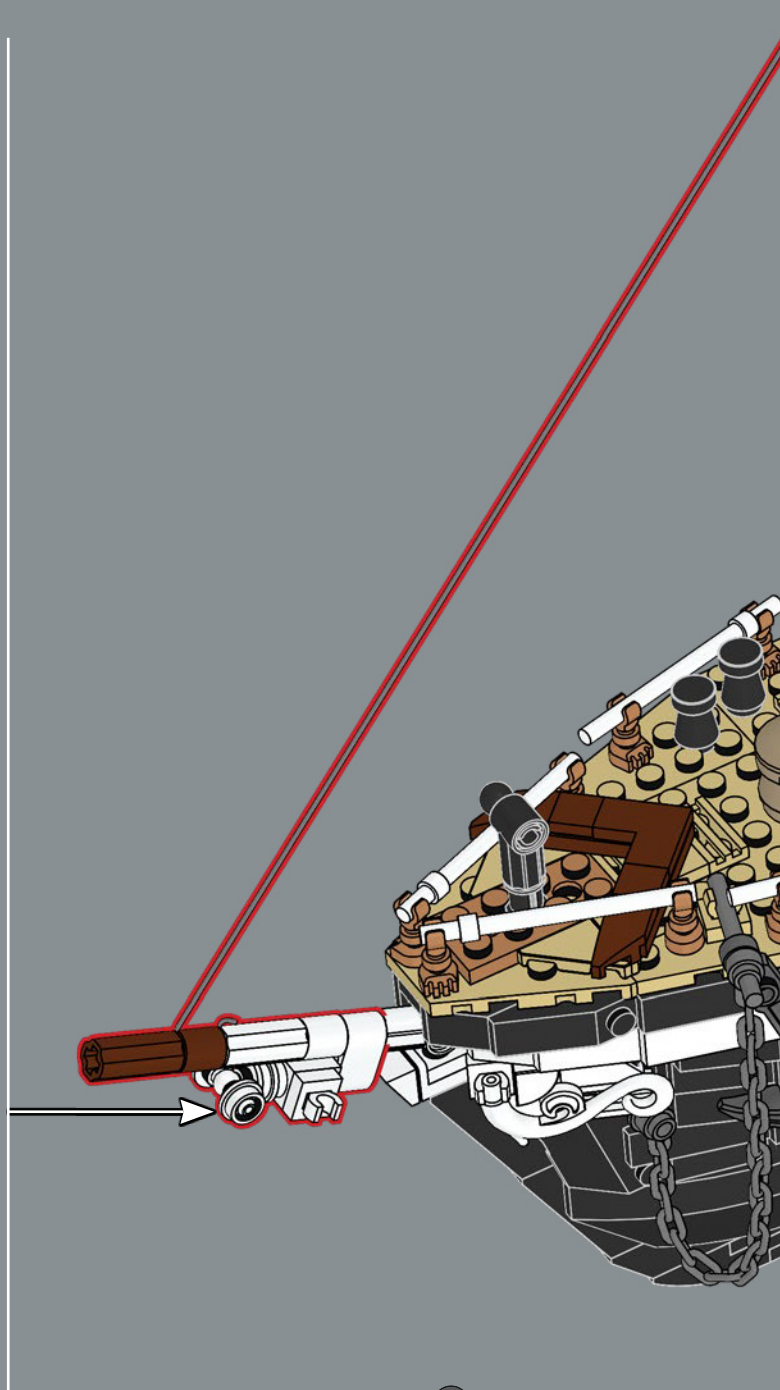
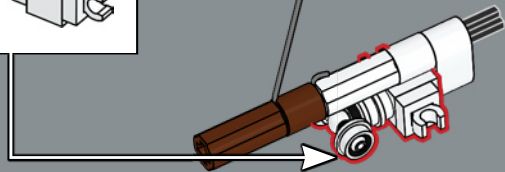
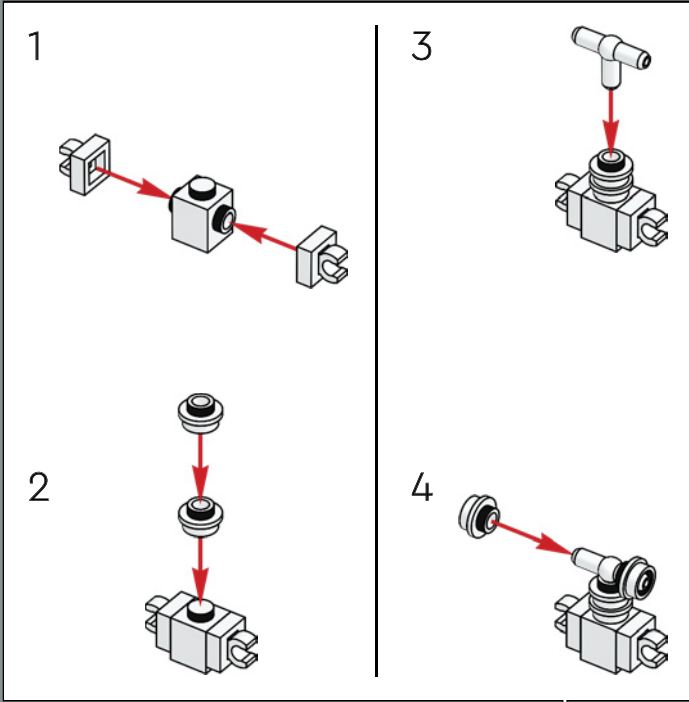



657

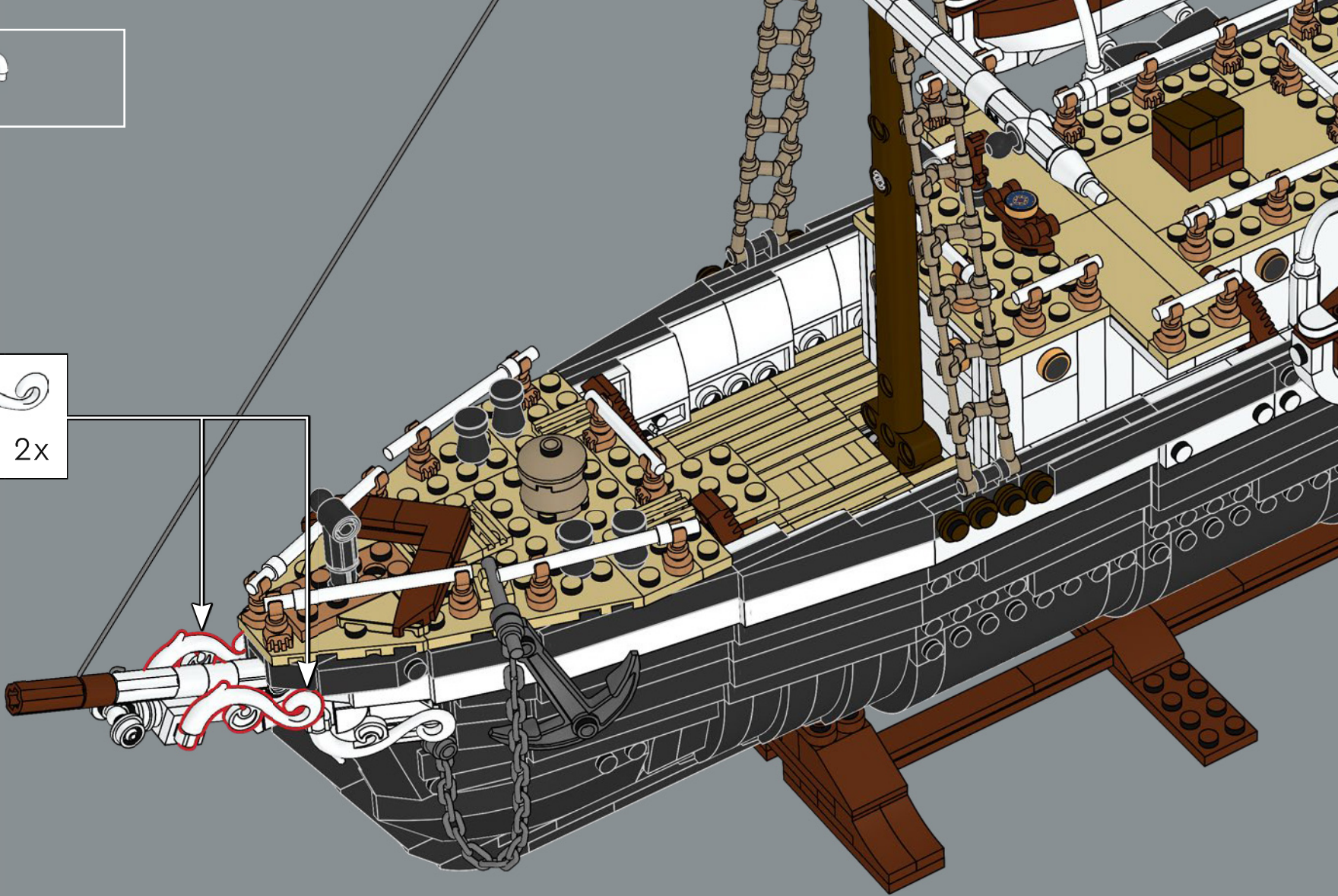
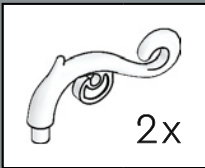

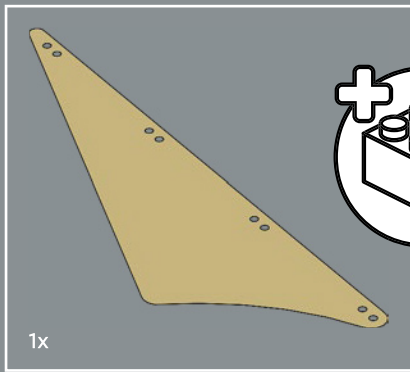

1x

658



Los textiles LEGO® tienen los mismos colores que los ladrillos LEGO. Para las velas, se consideró que la opción más atractiva y apropiada era el marrón claro.

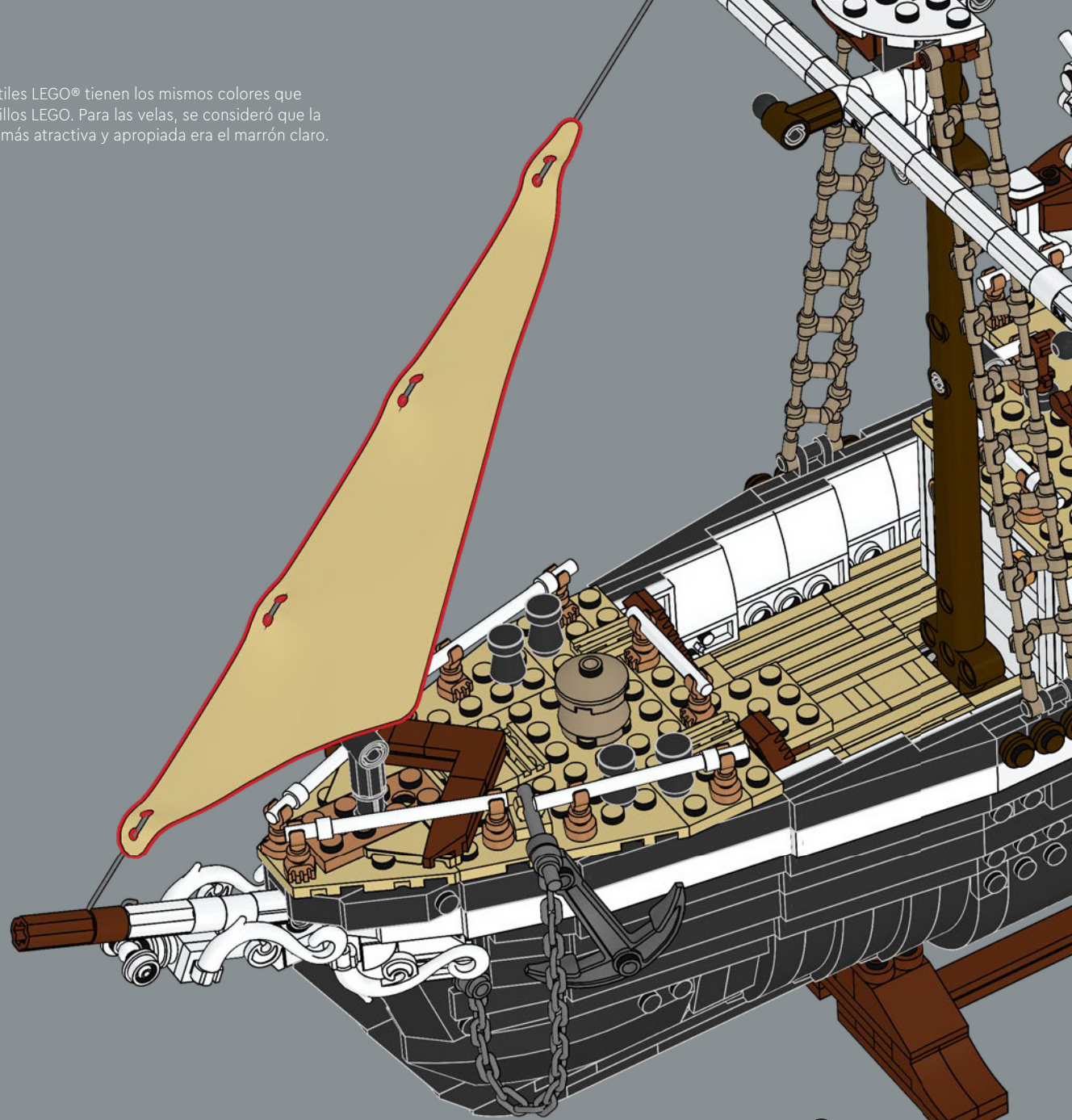

659

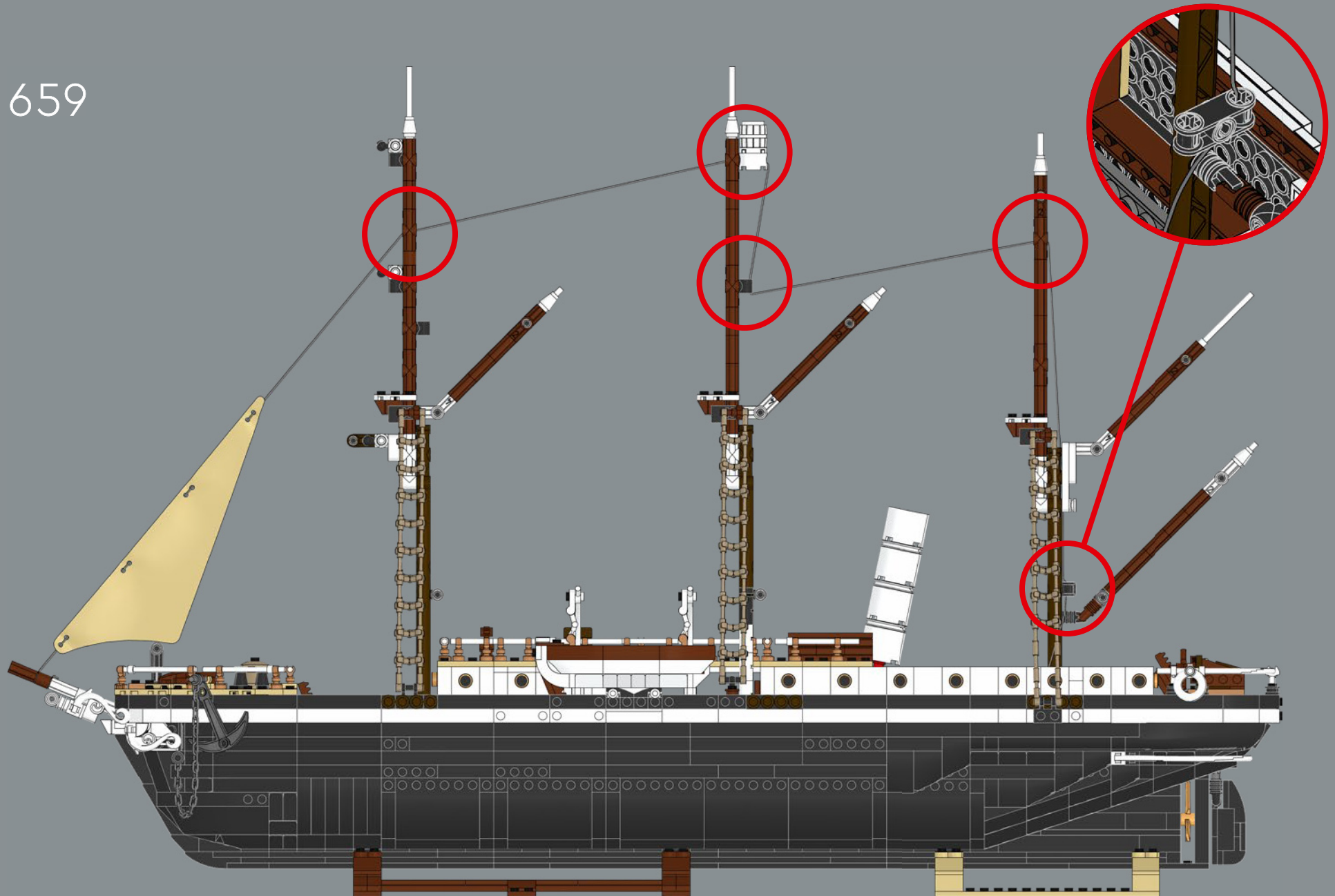

1x



660

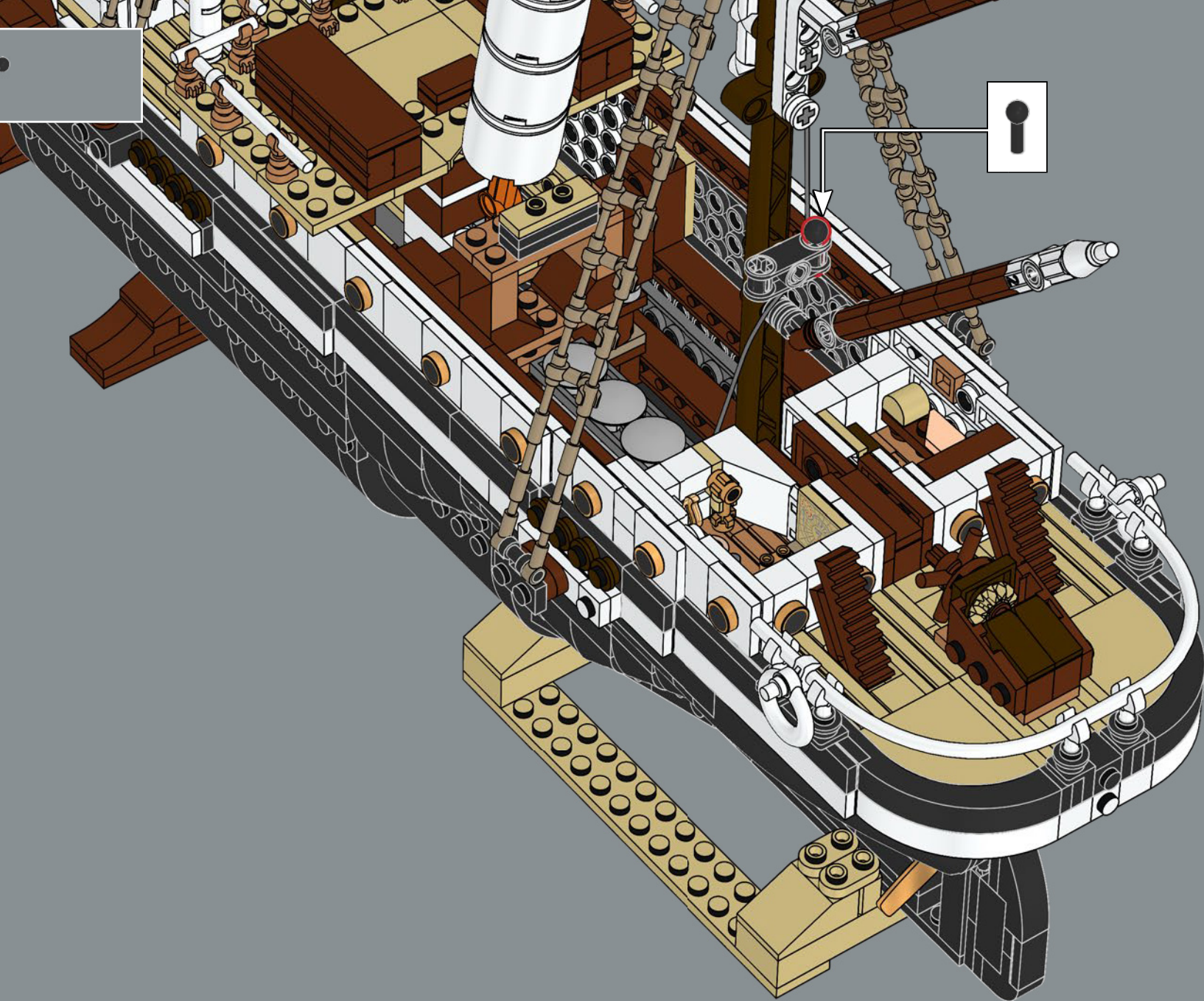

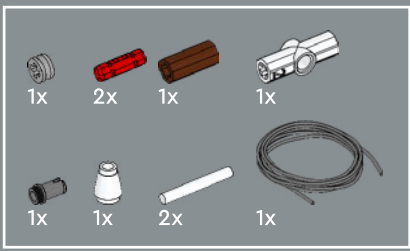

661

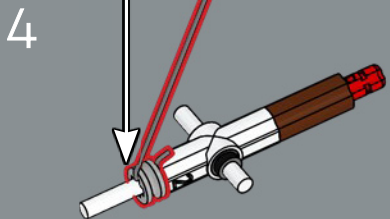
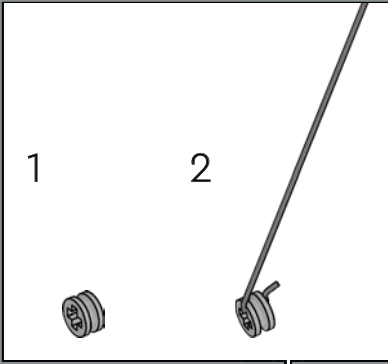
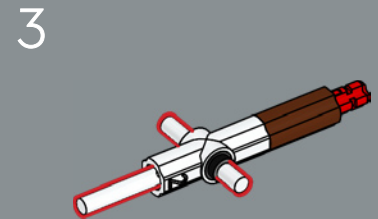
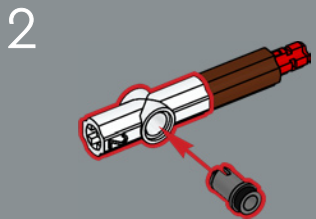
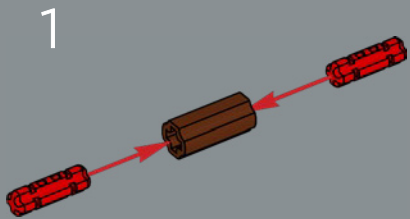

5

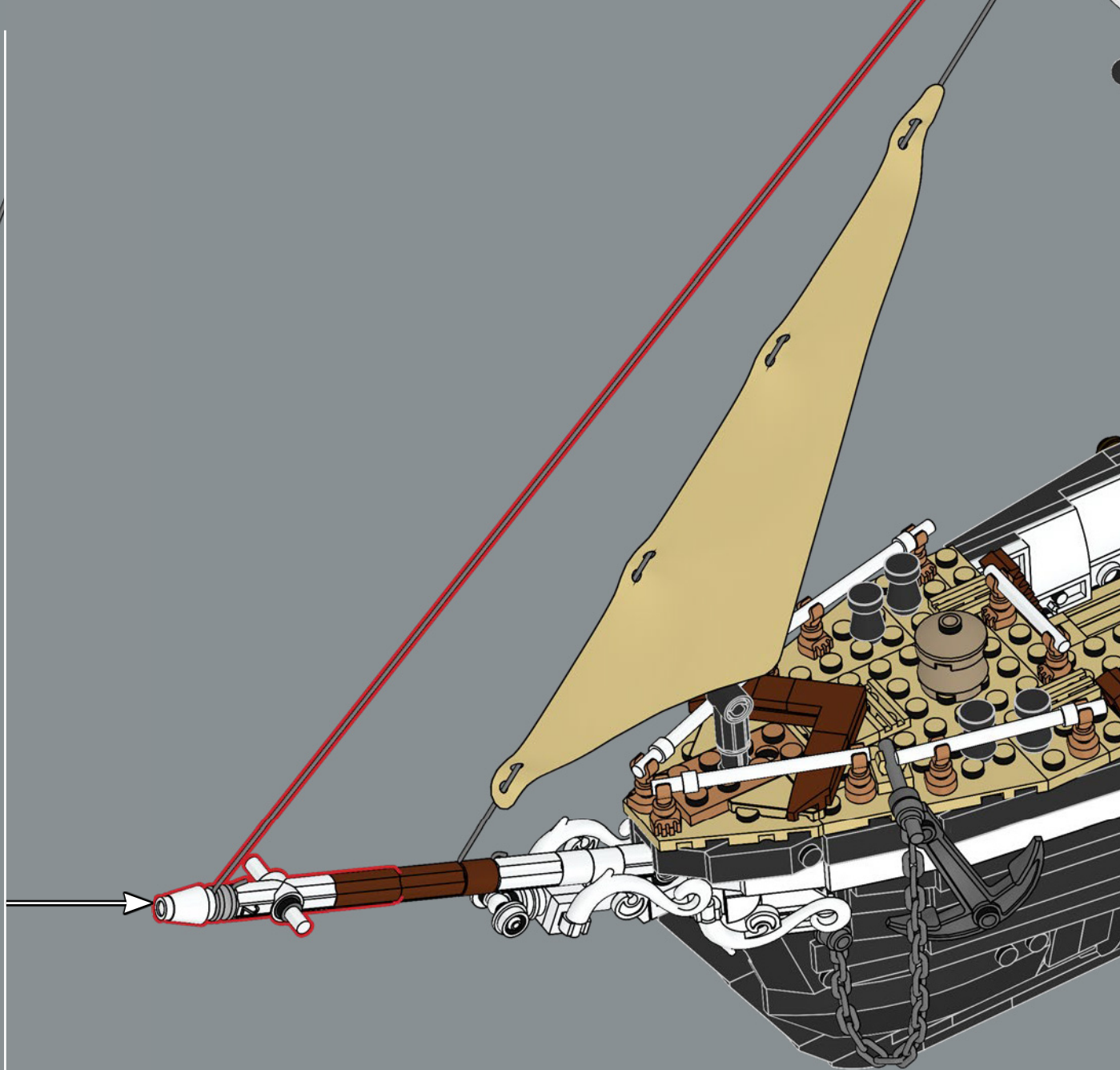
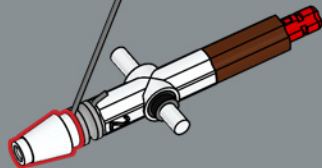

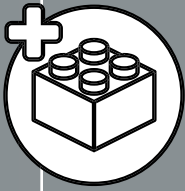
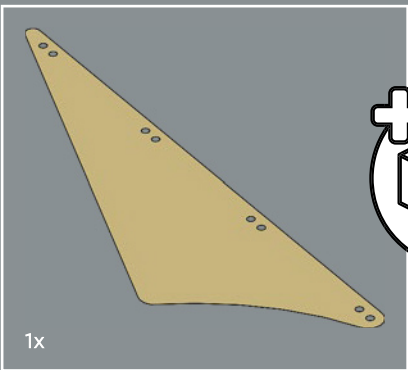

662

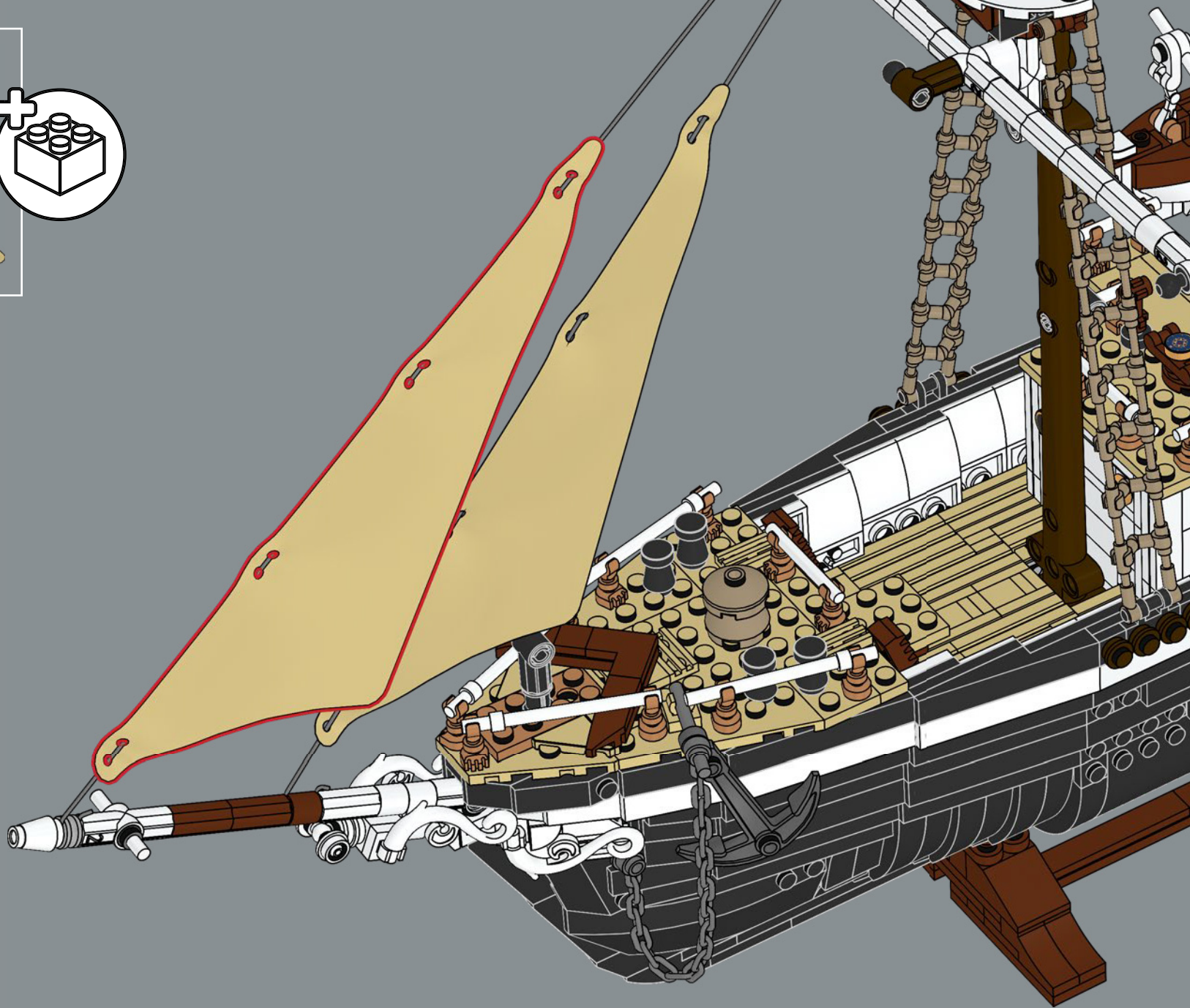

663

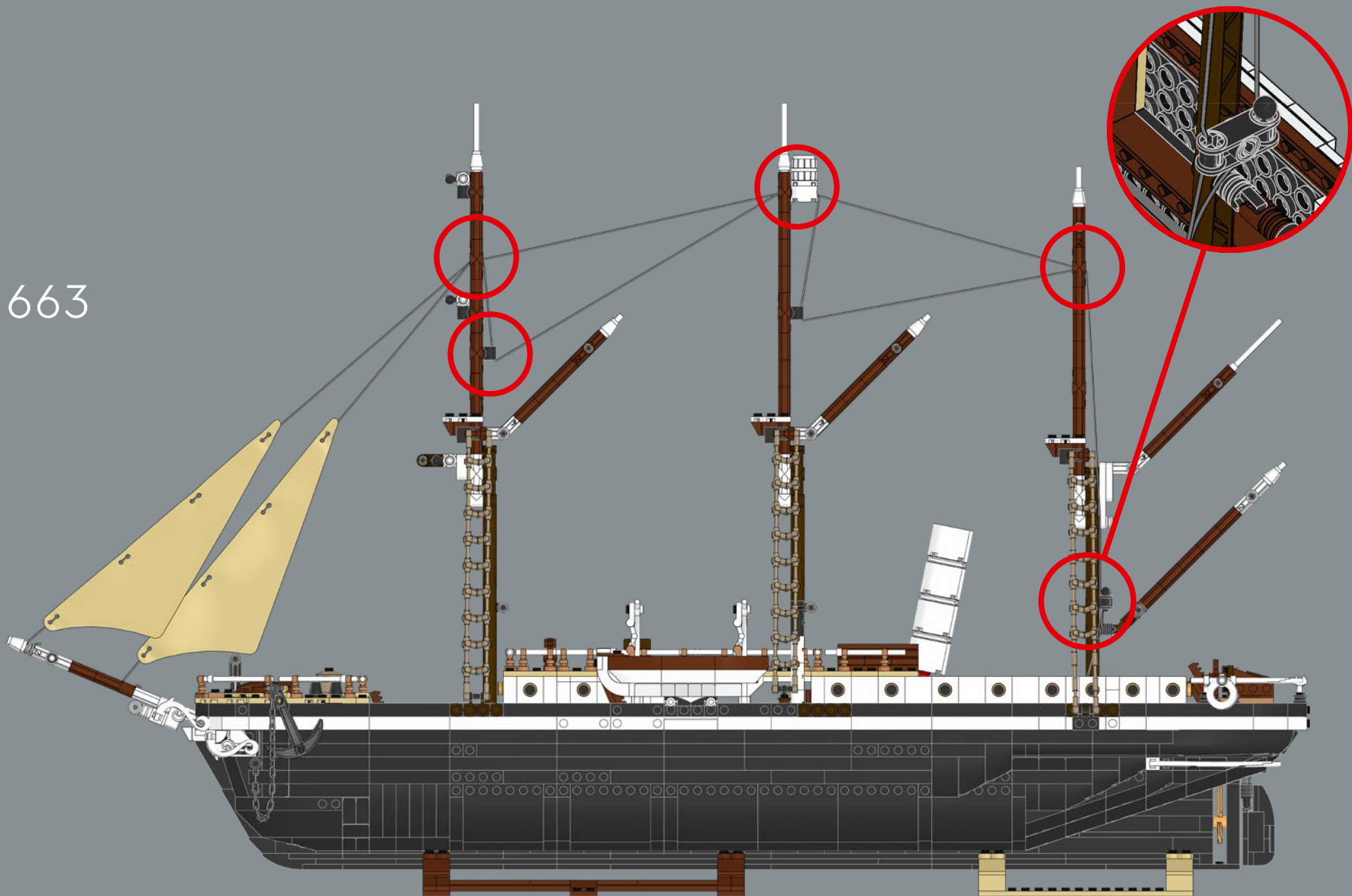



1x

664



Las cuerdas LEGO® se cortan con calor para evitar que los extremos se deshilachen. Para este modelo, encontramos una solución sin nudos ni cortes: enrollar la cuerda sobrante alrededor de una bobina que se guarda bajo la cubierta.

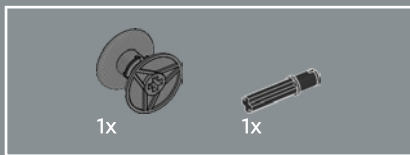

665

1

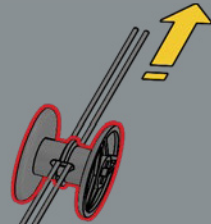

2

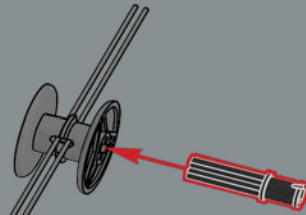

3

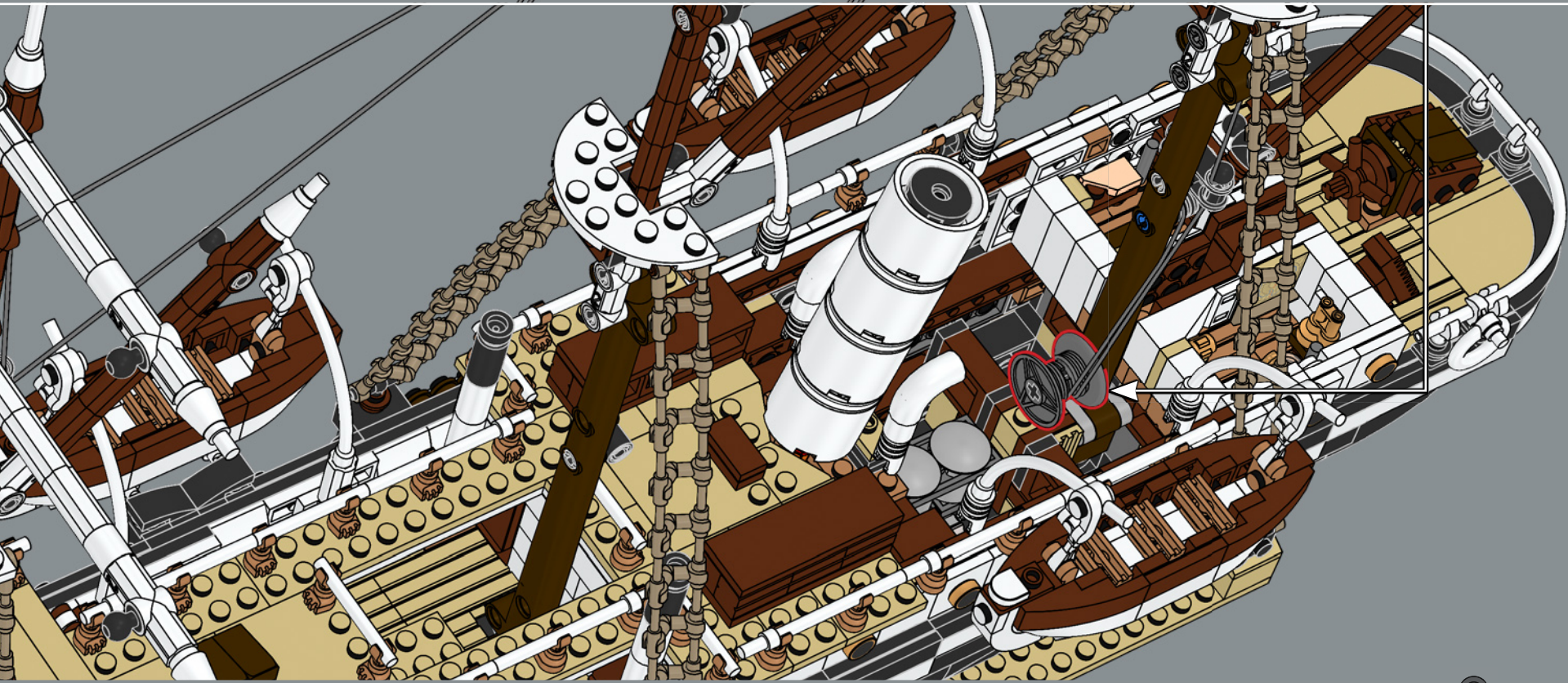
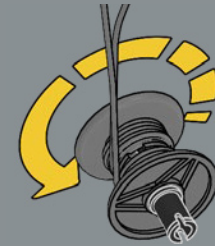

666

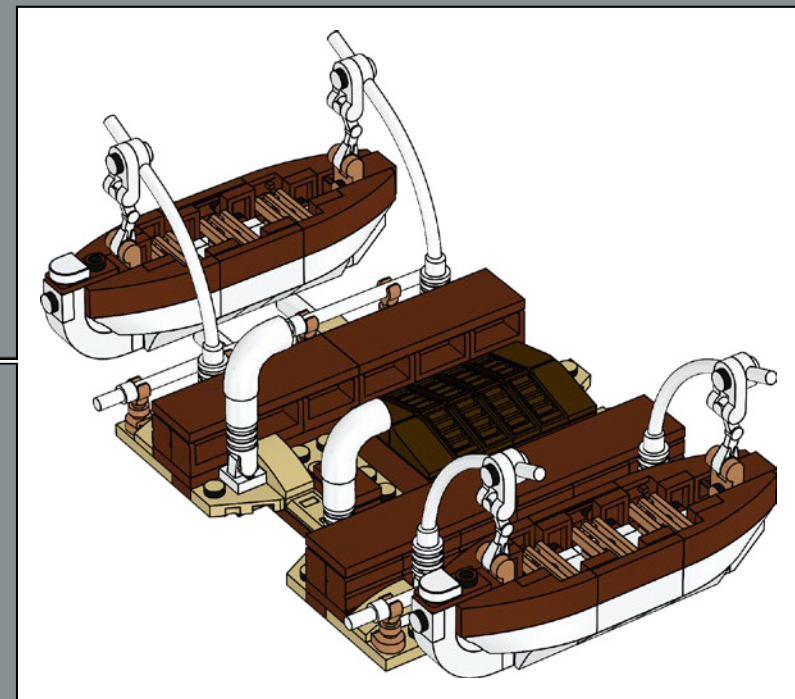
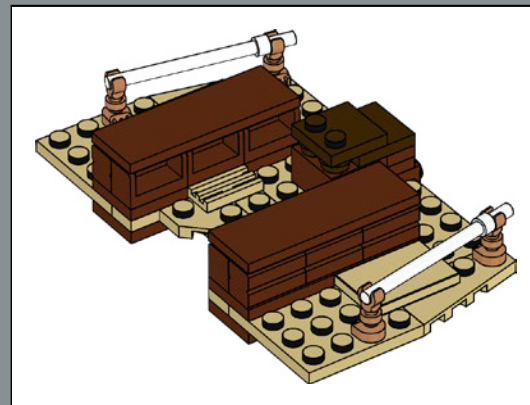
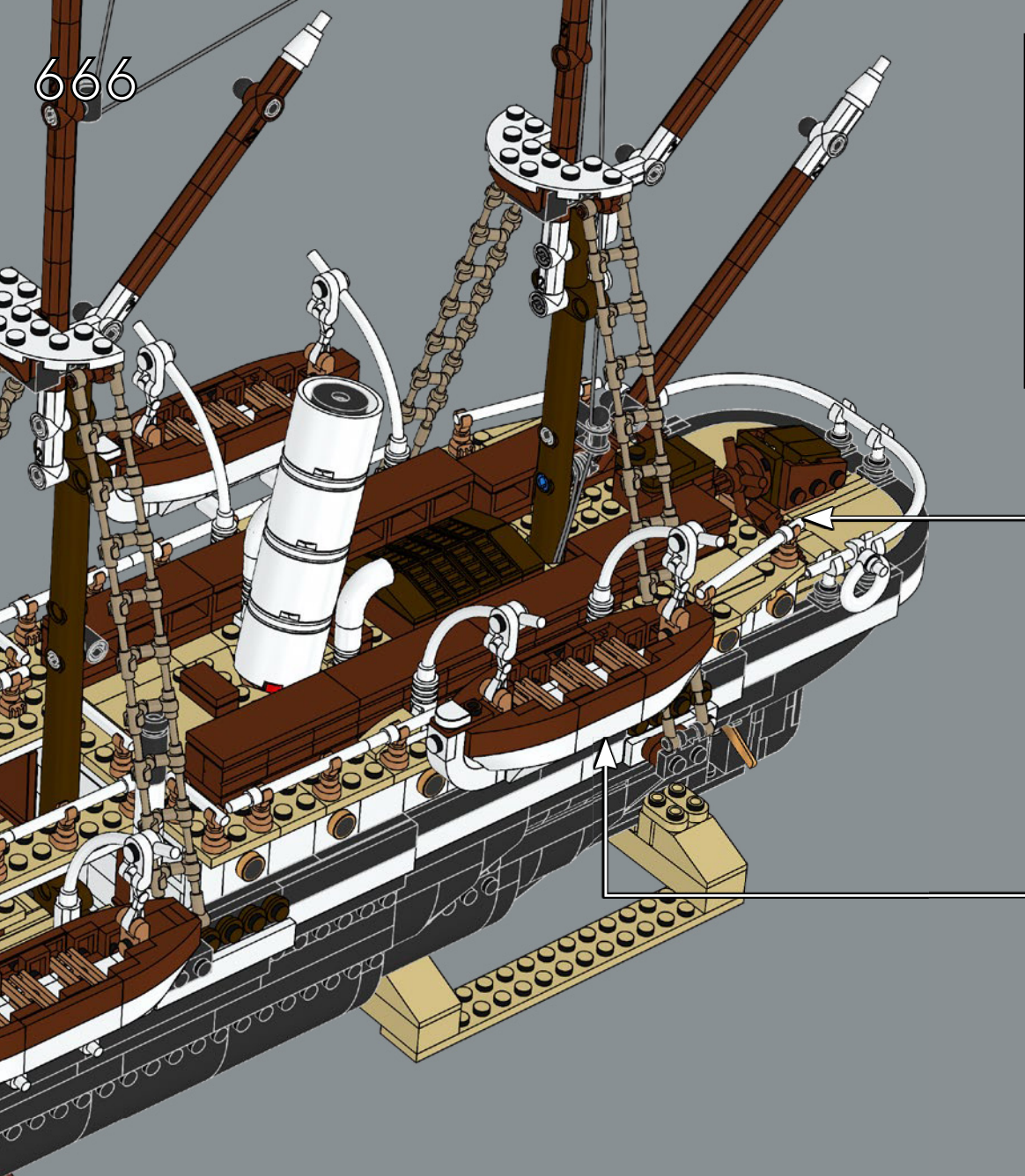

667

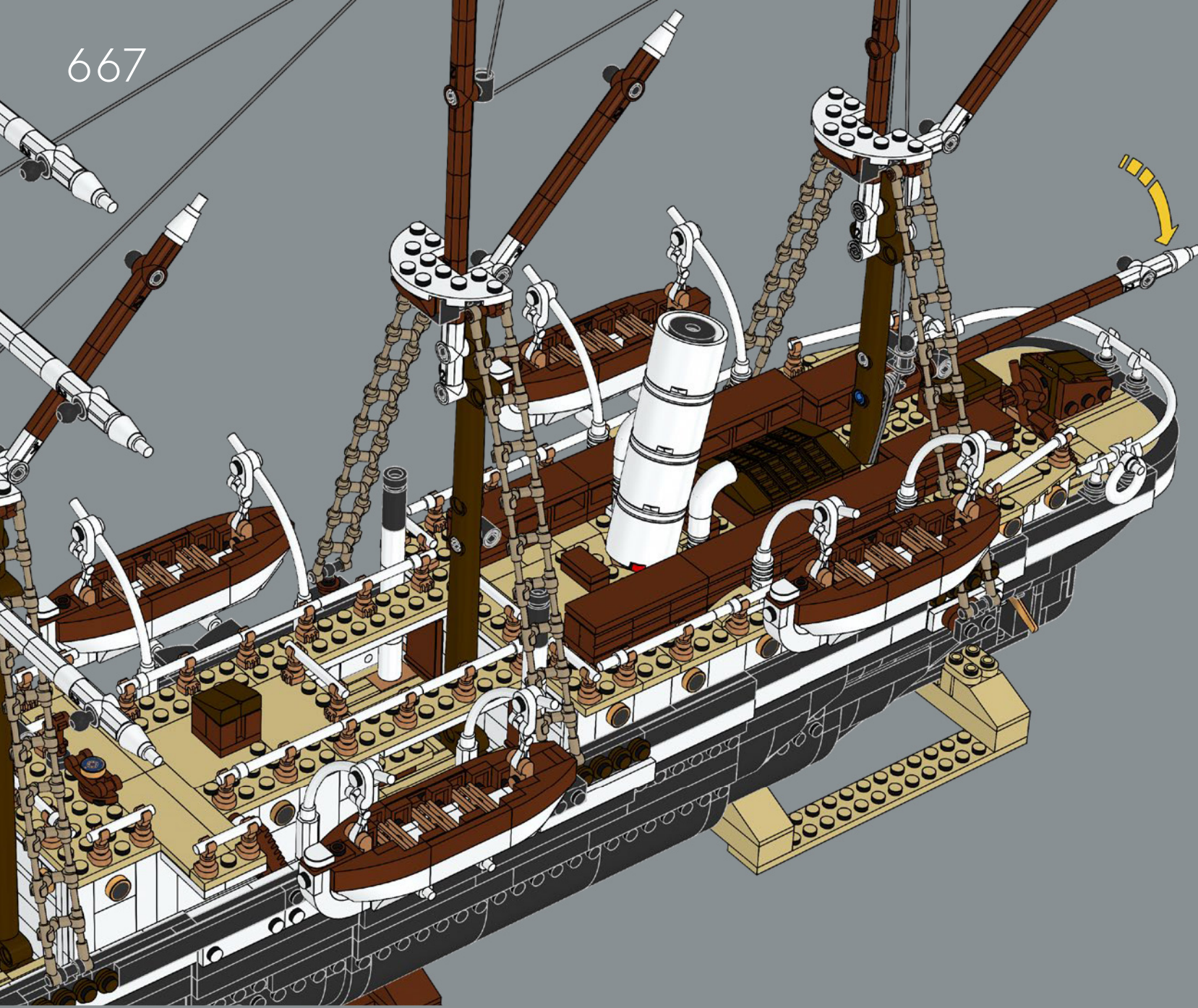

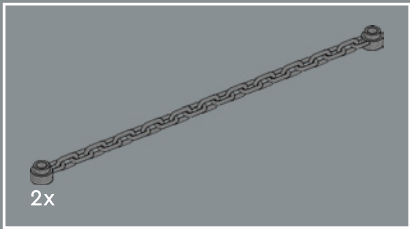

668

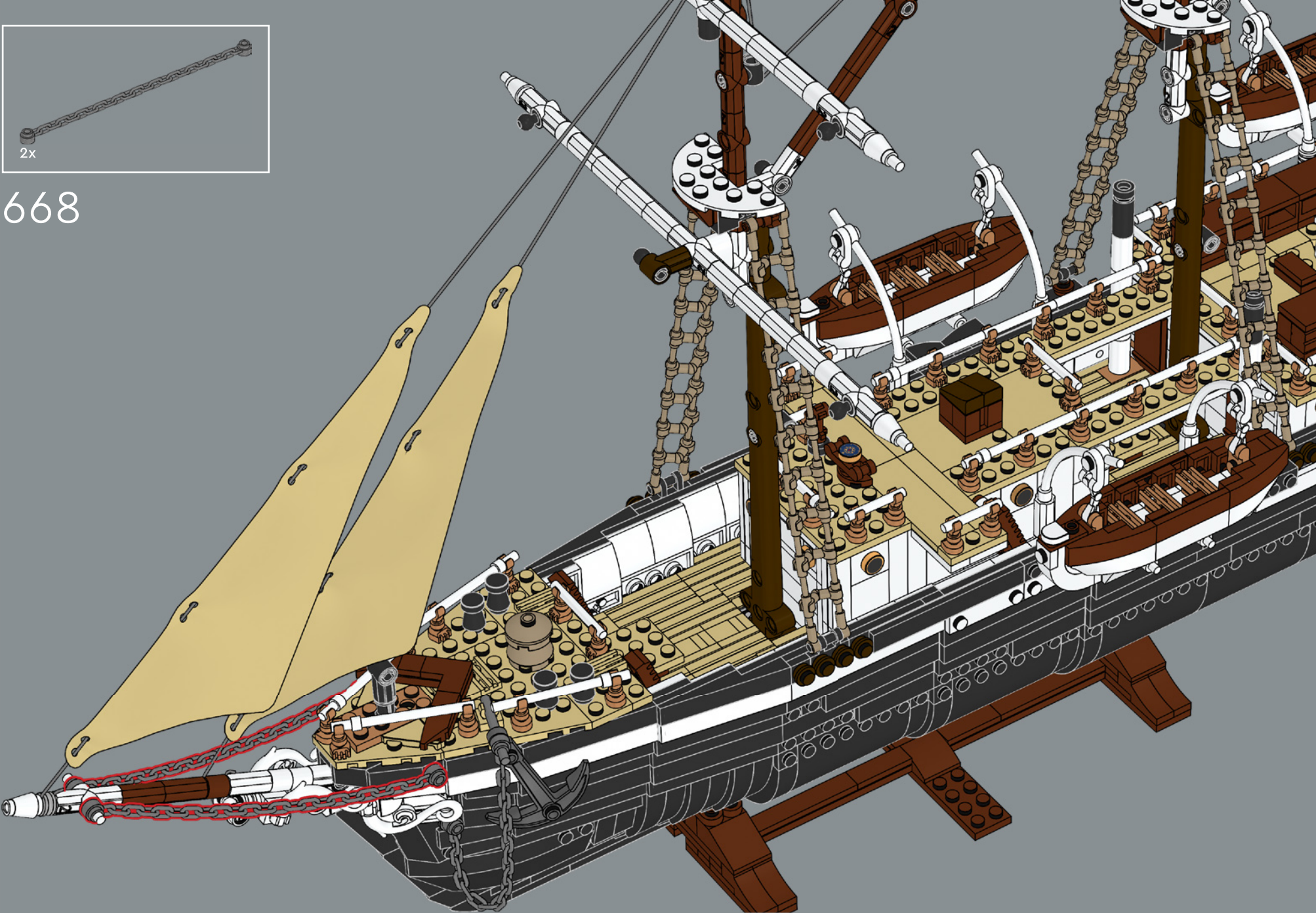

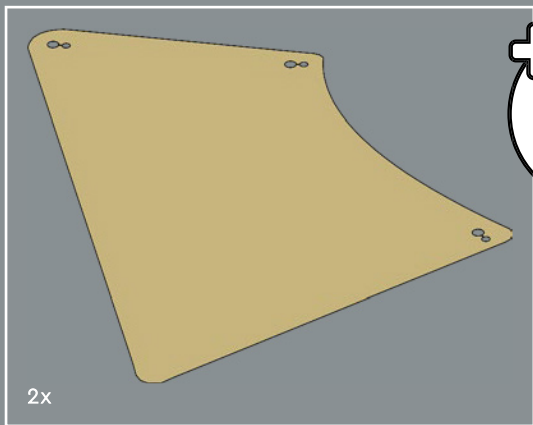

2x

669



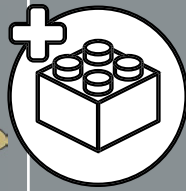
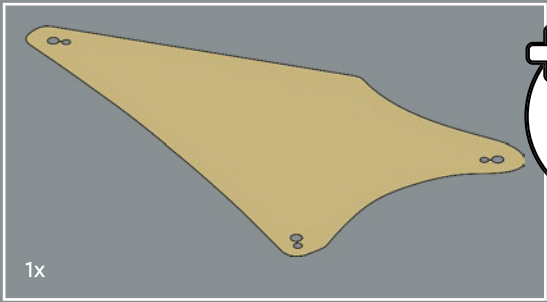

670

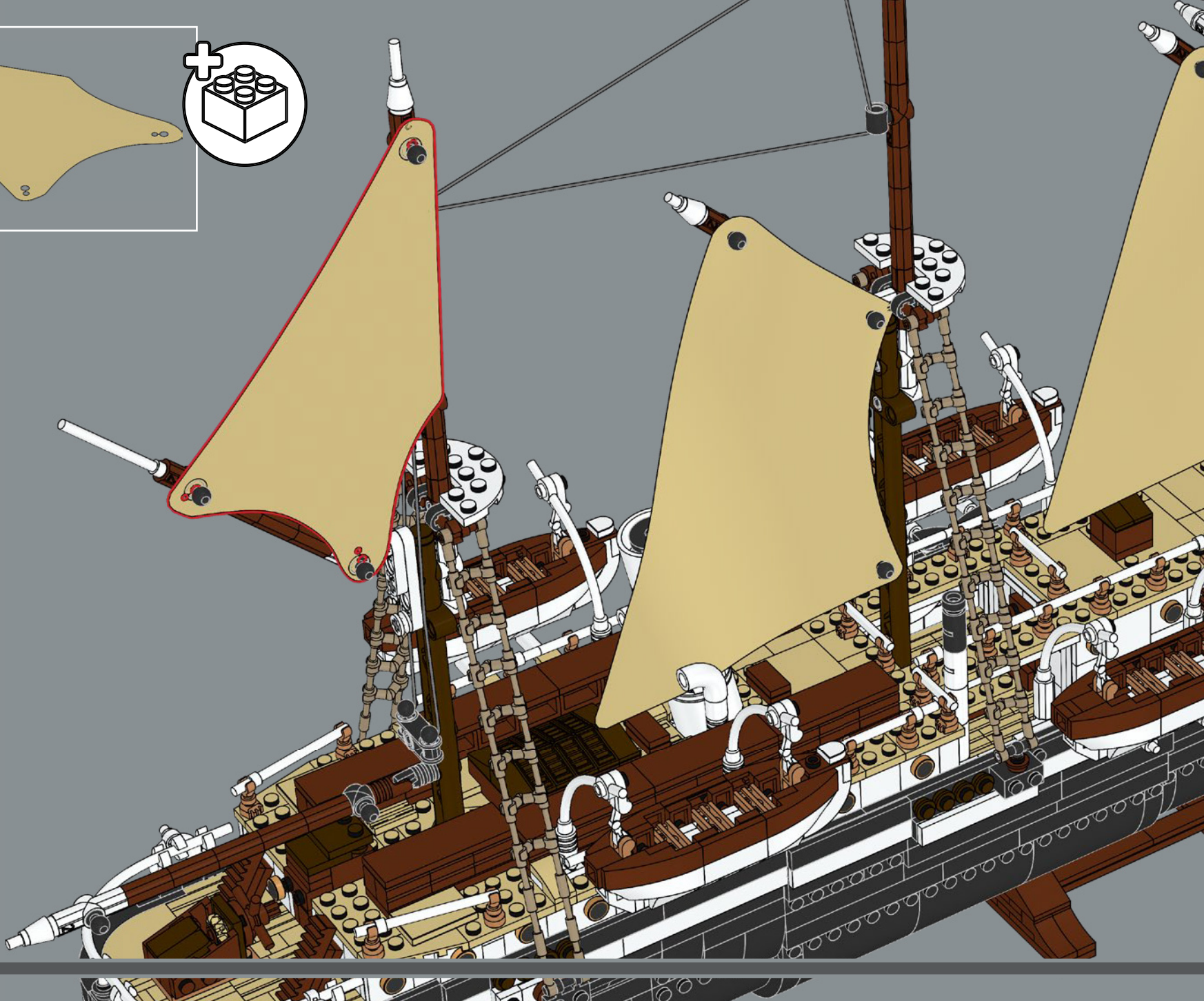



1x

671

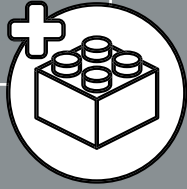

Esta bandera británica denominada "pabellón rojo" era la que debía ondear en las embarcaciones mercantes y privadas de aquella época.



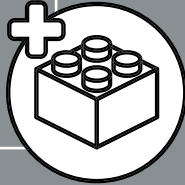
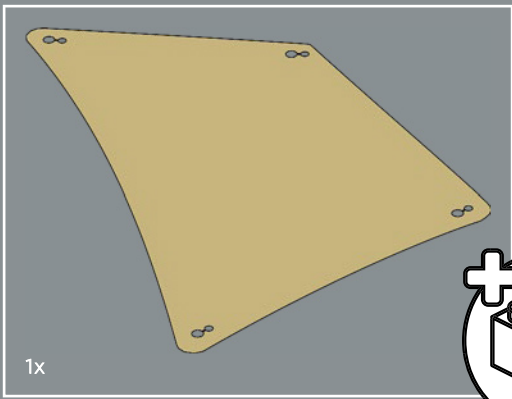

1x

672

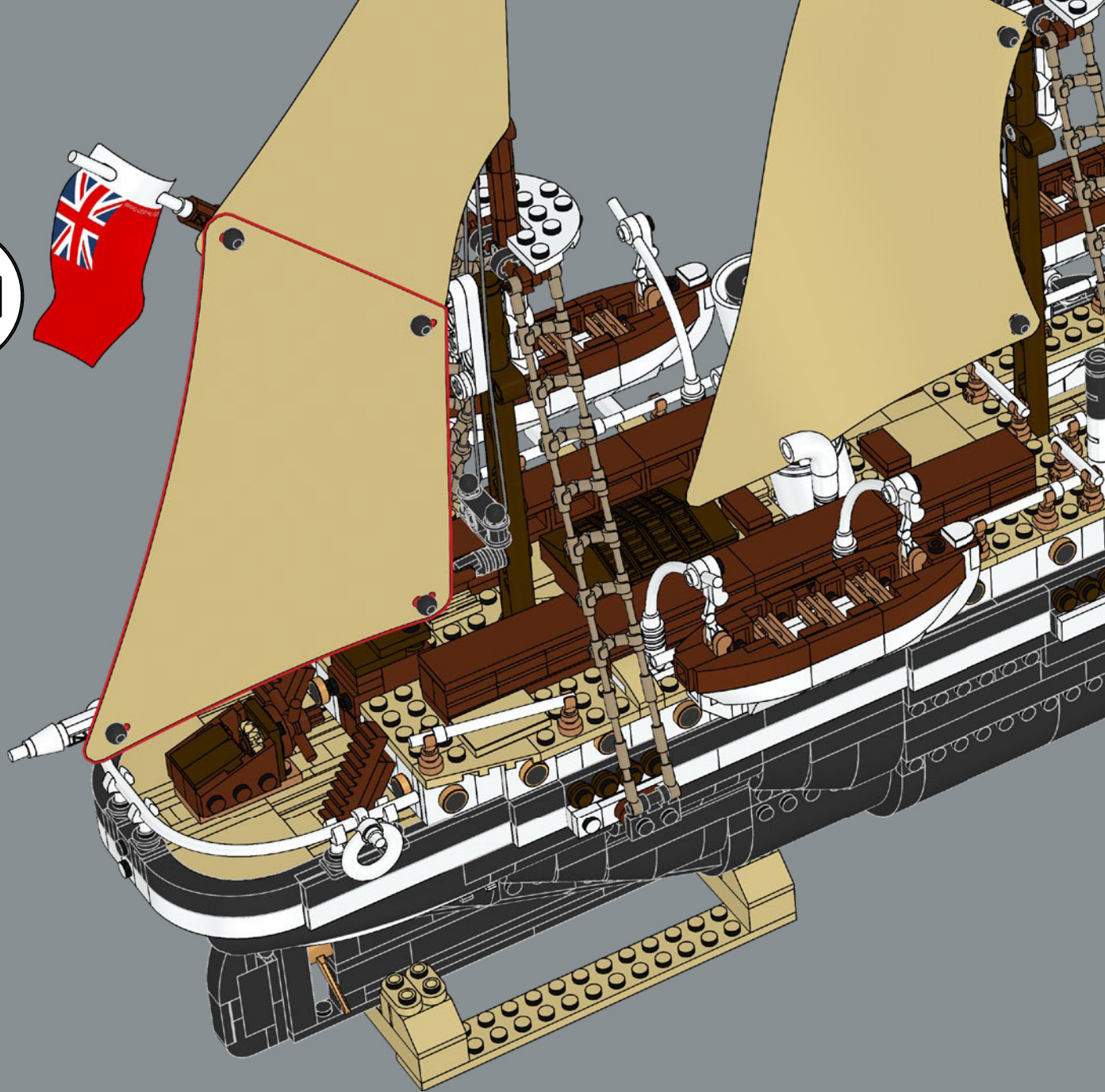

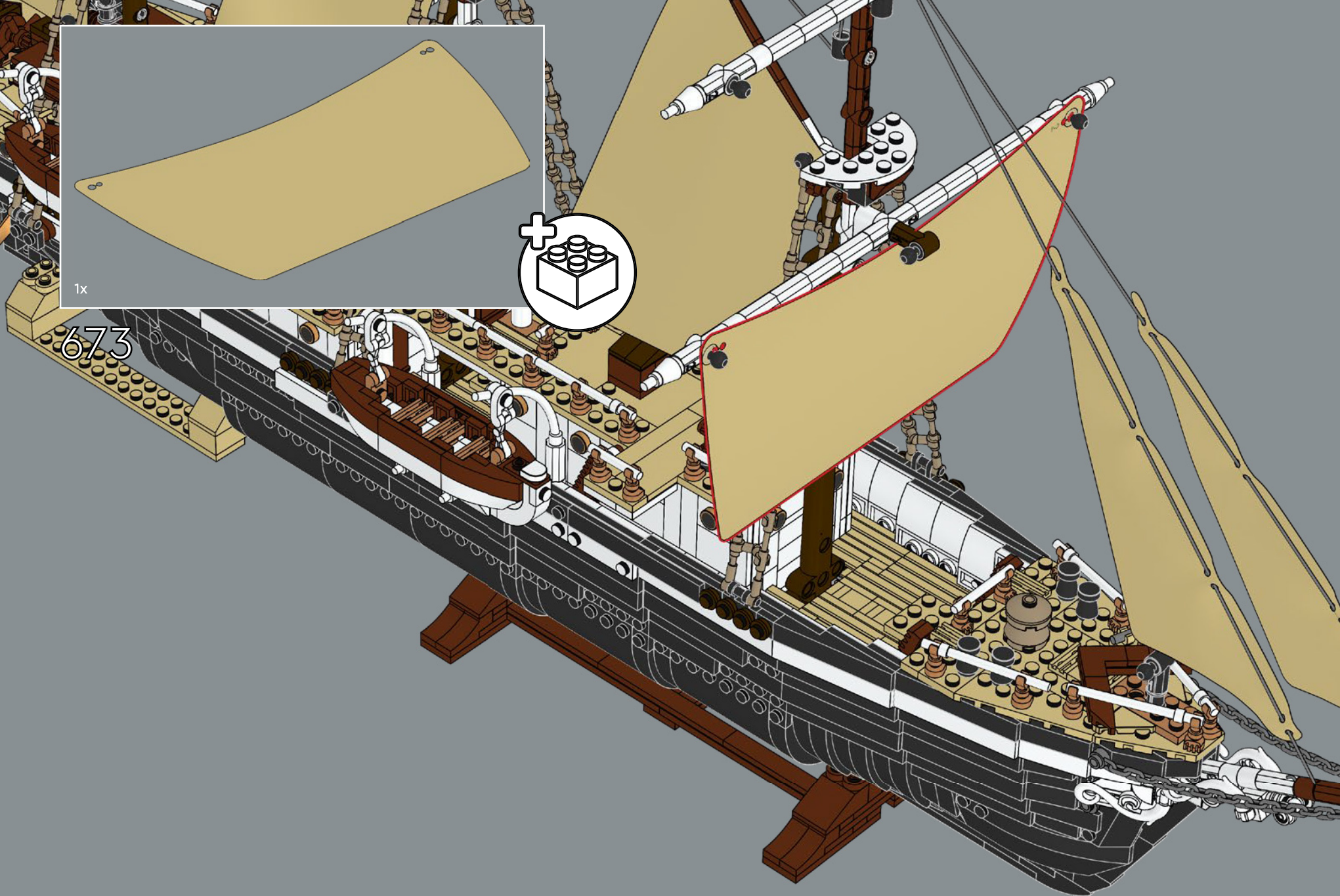

1x

673

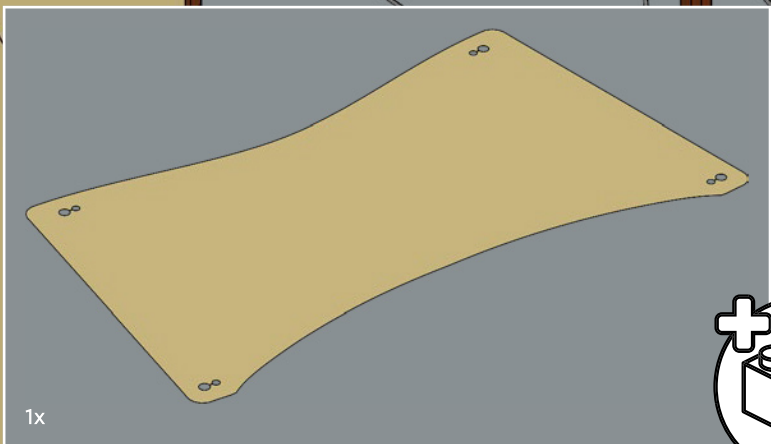

1x

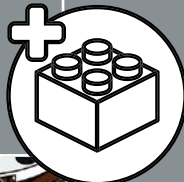

674

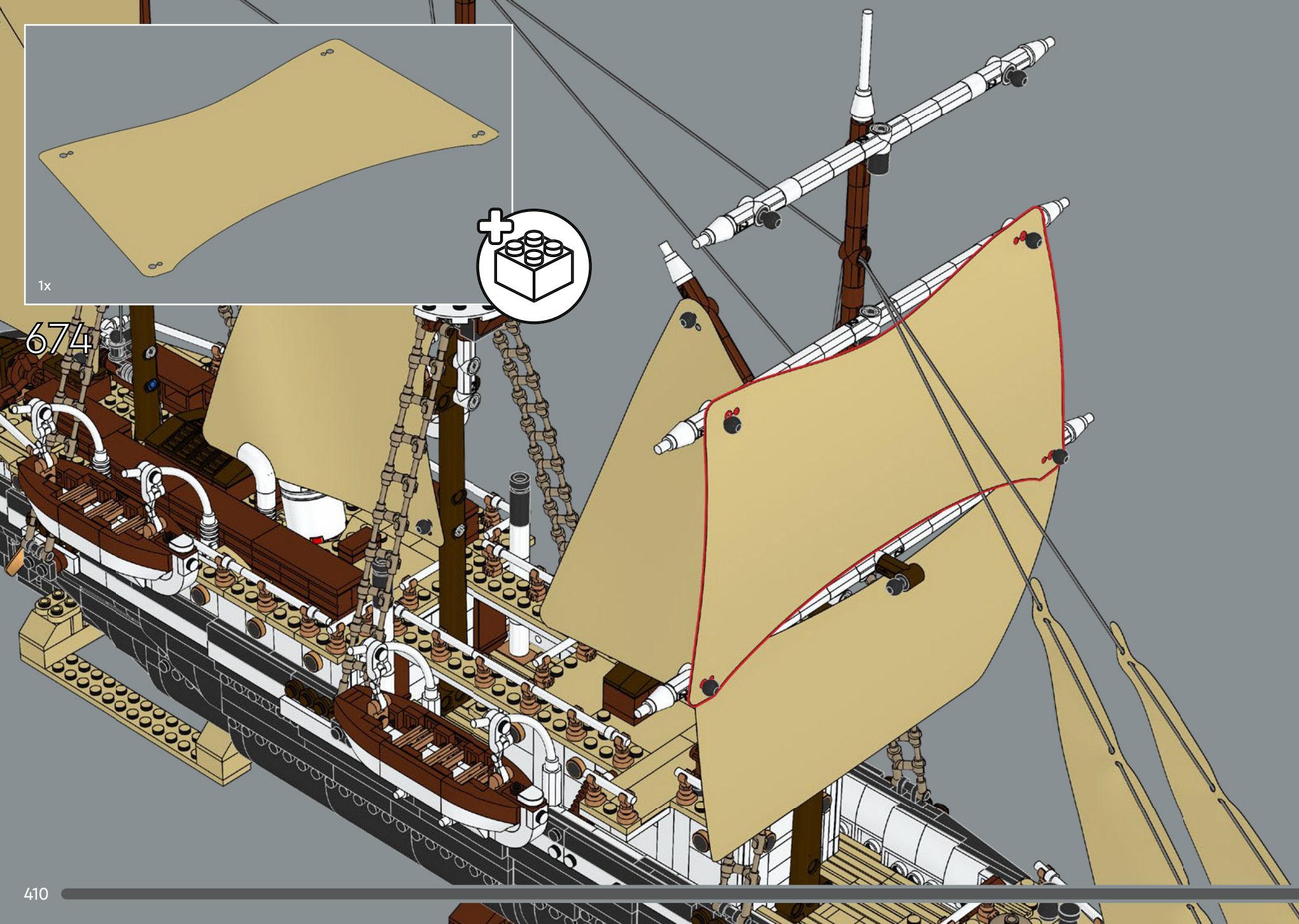

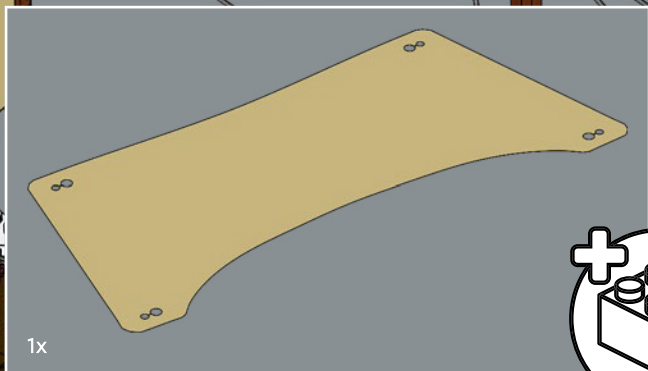

1x

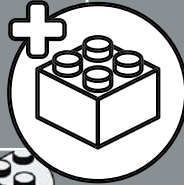

675

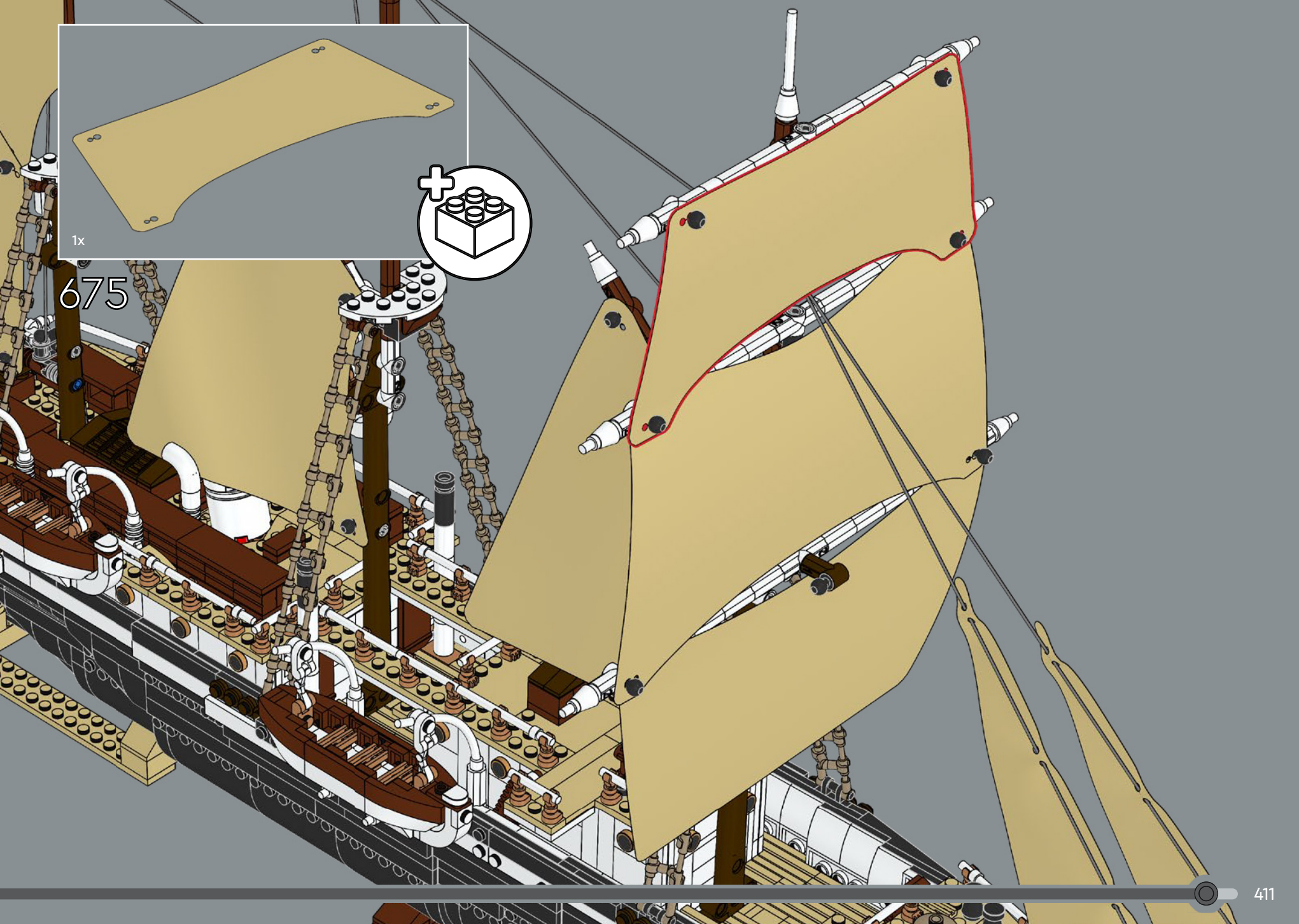

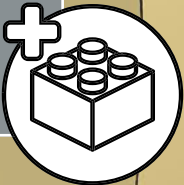
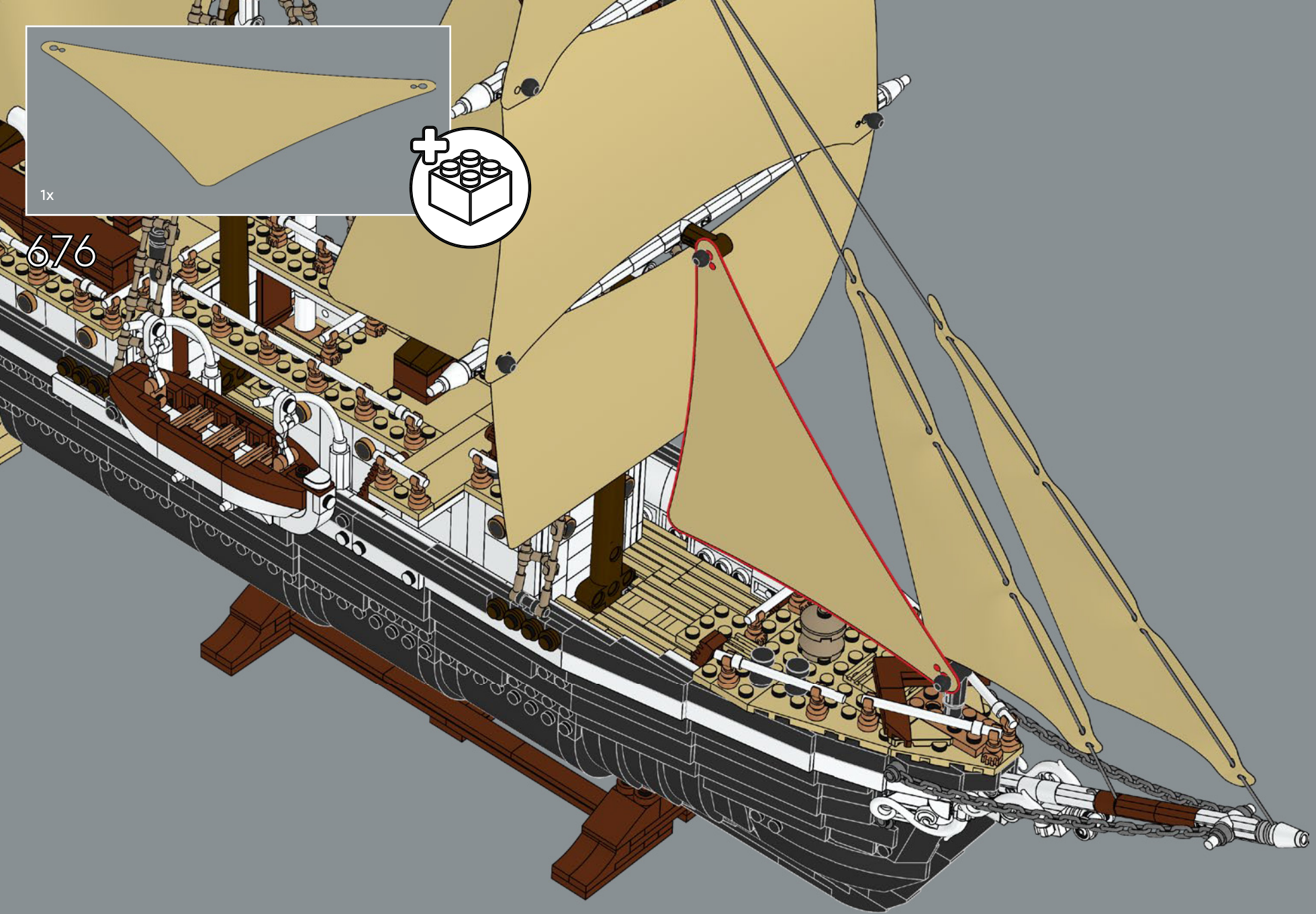

1x

676

677

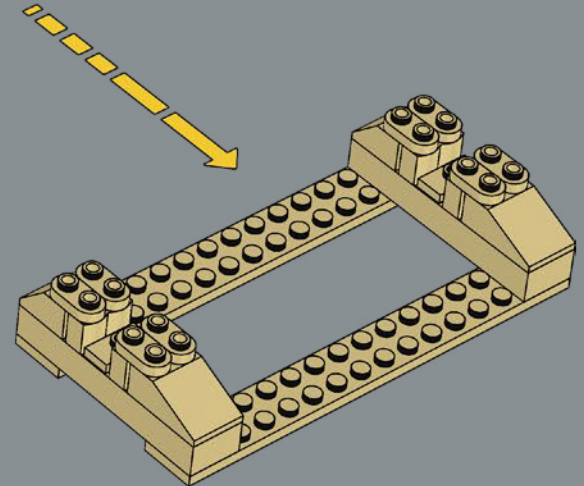
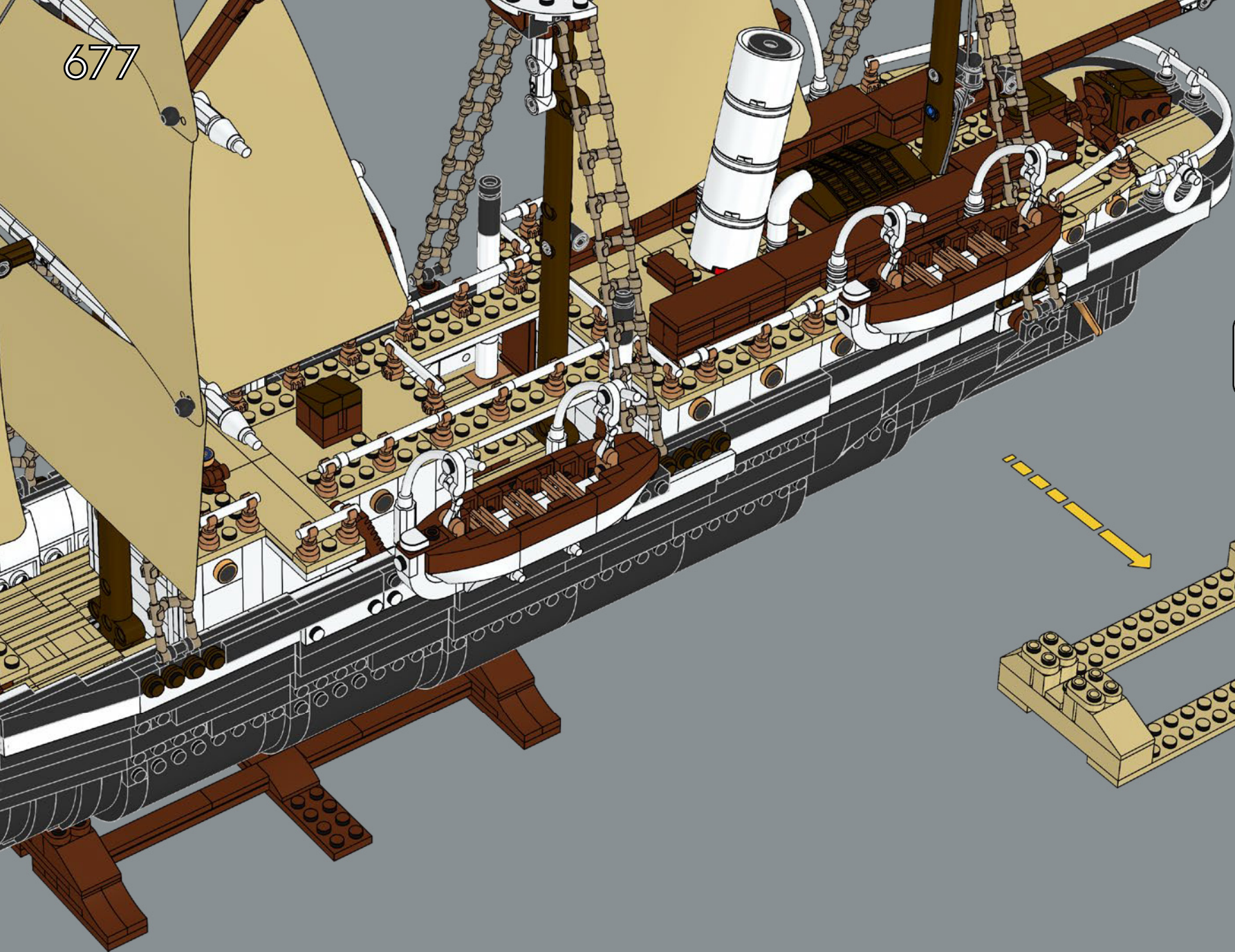

678

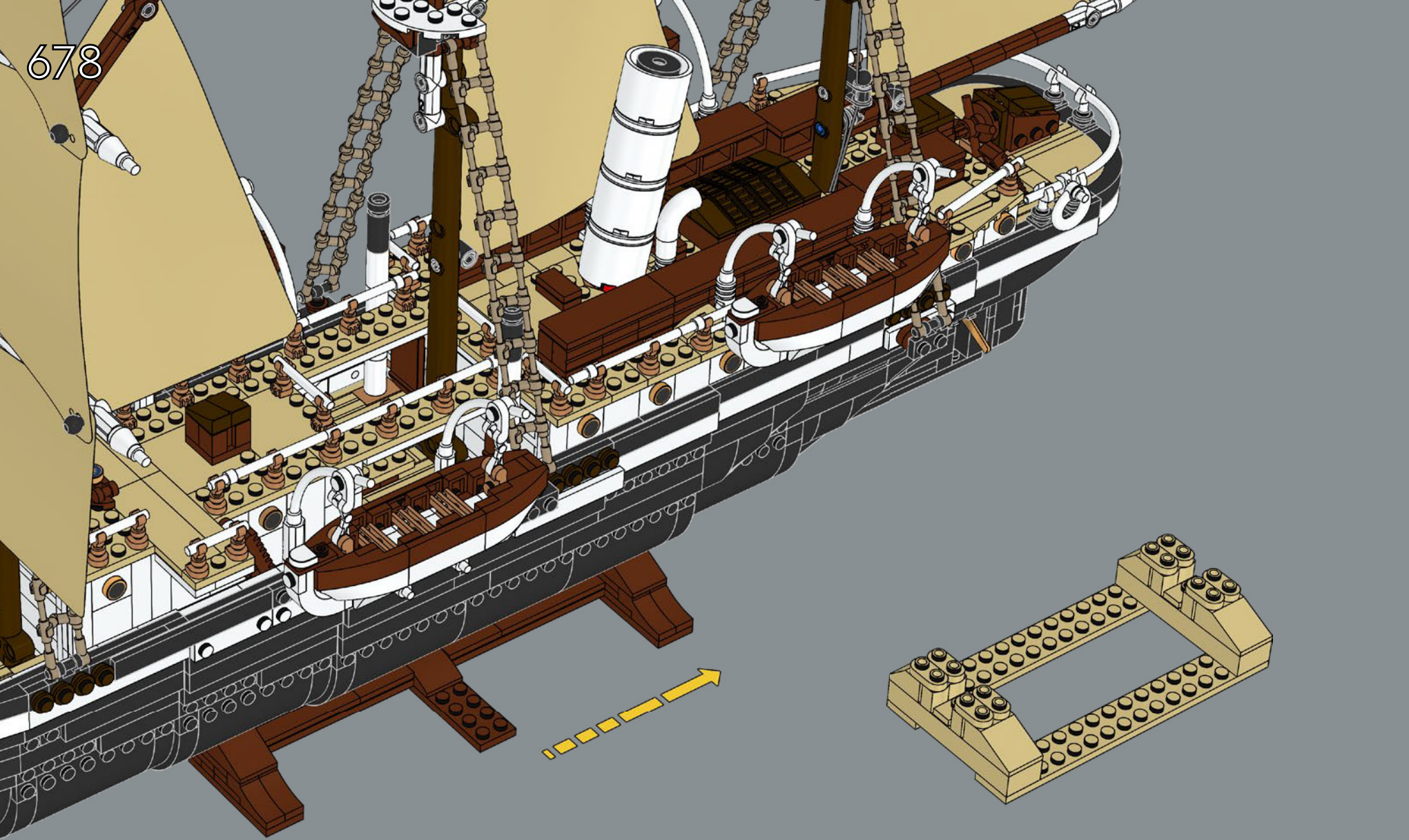

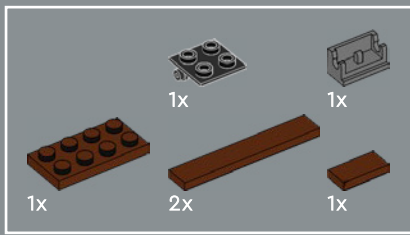

679

1

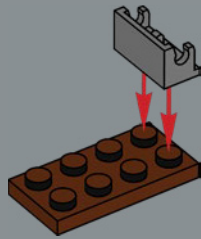

2

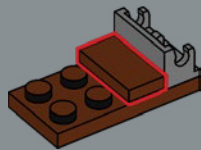

3

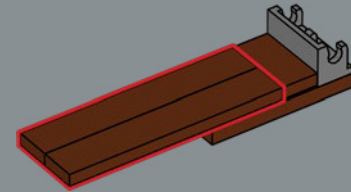

4

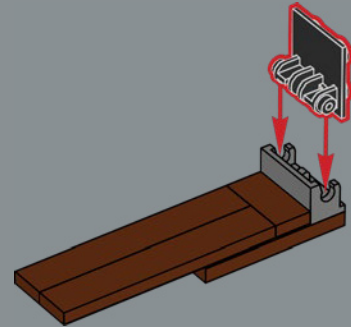

5

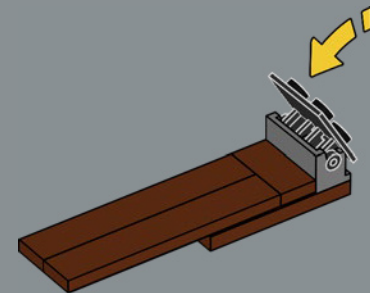

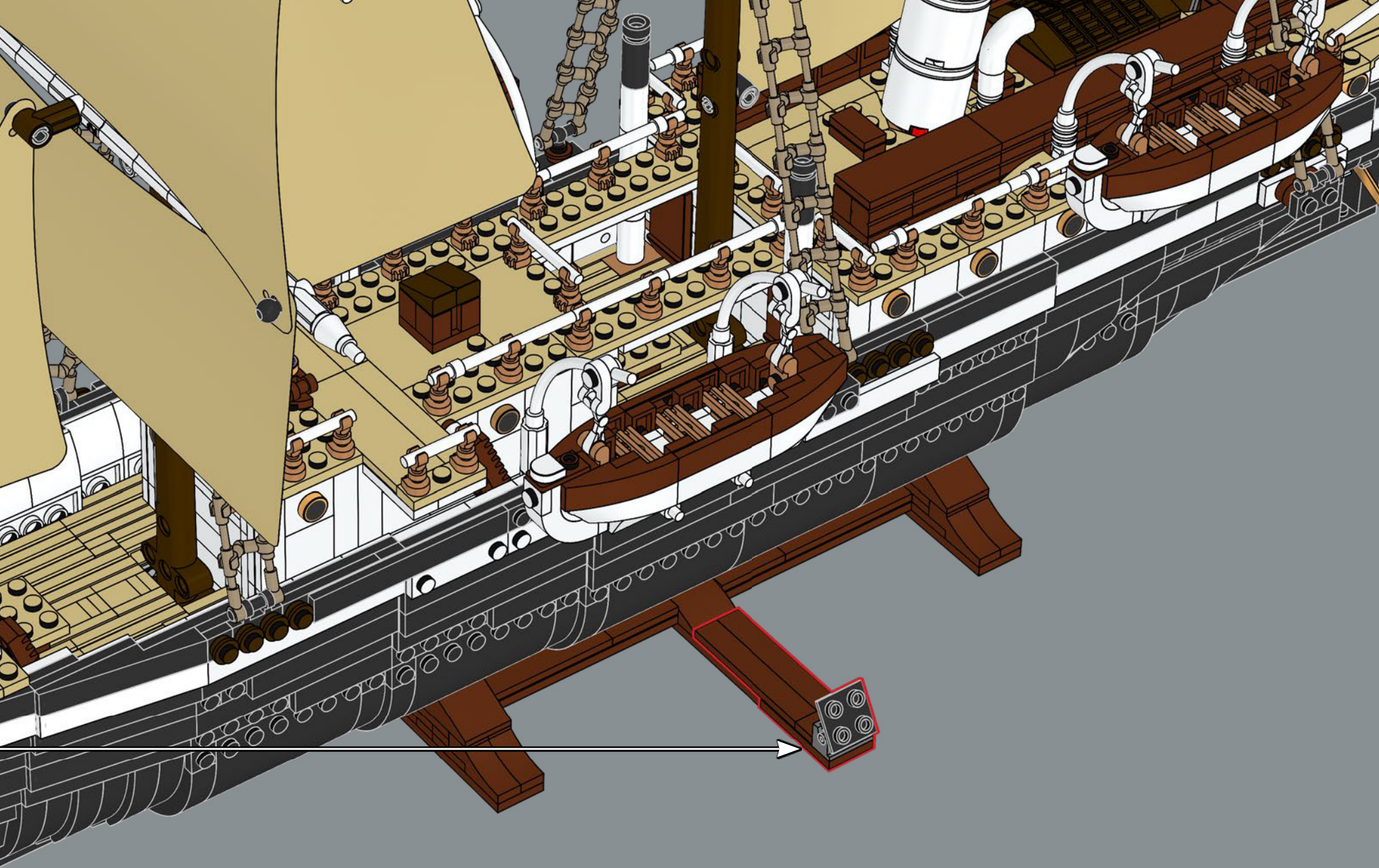

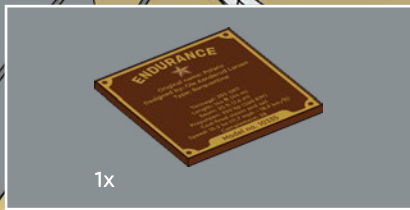

680

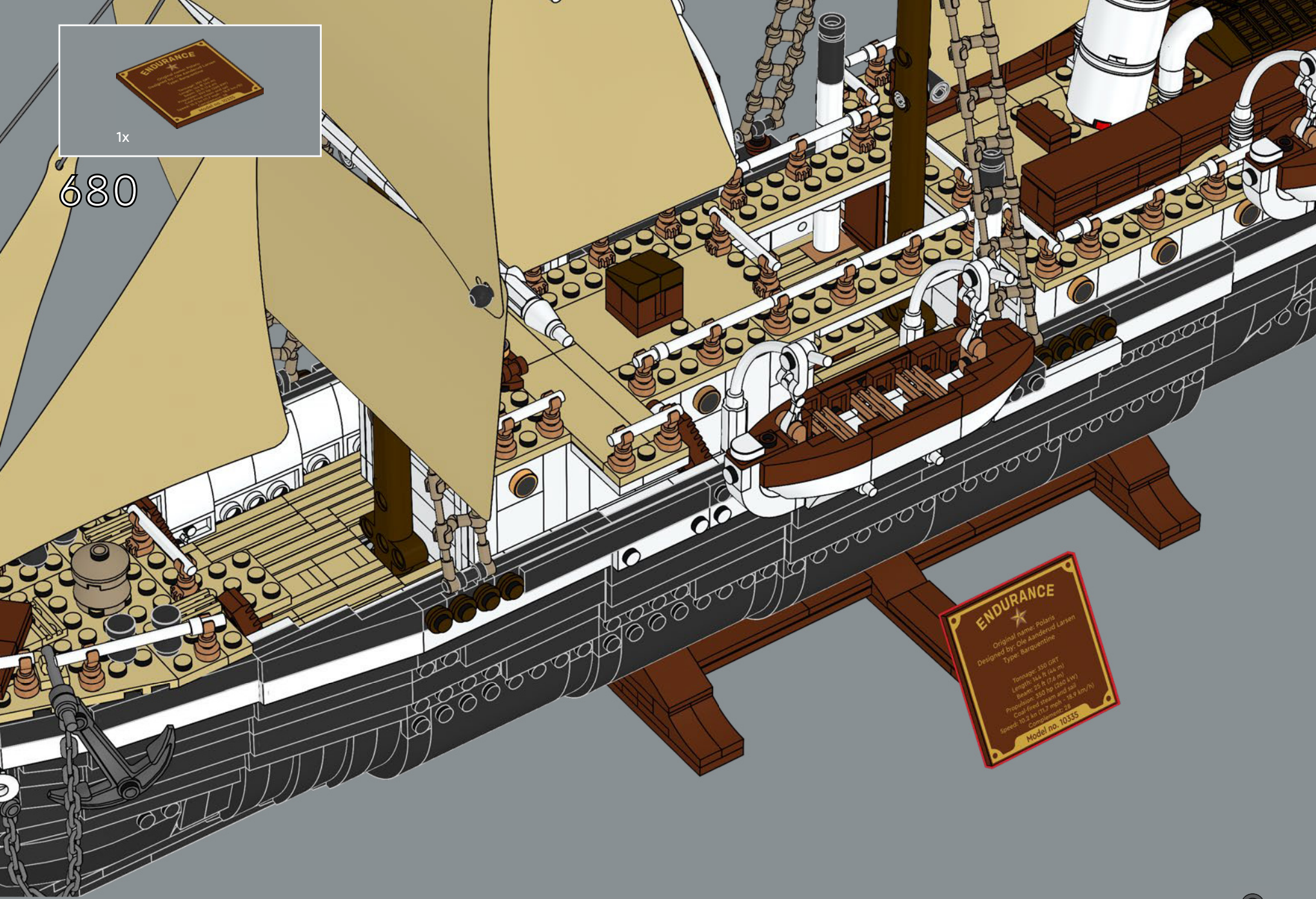

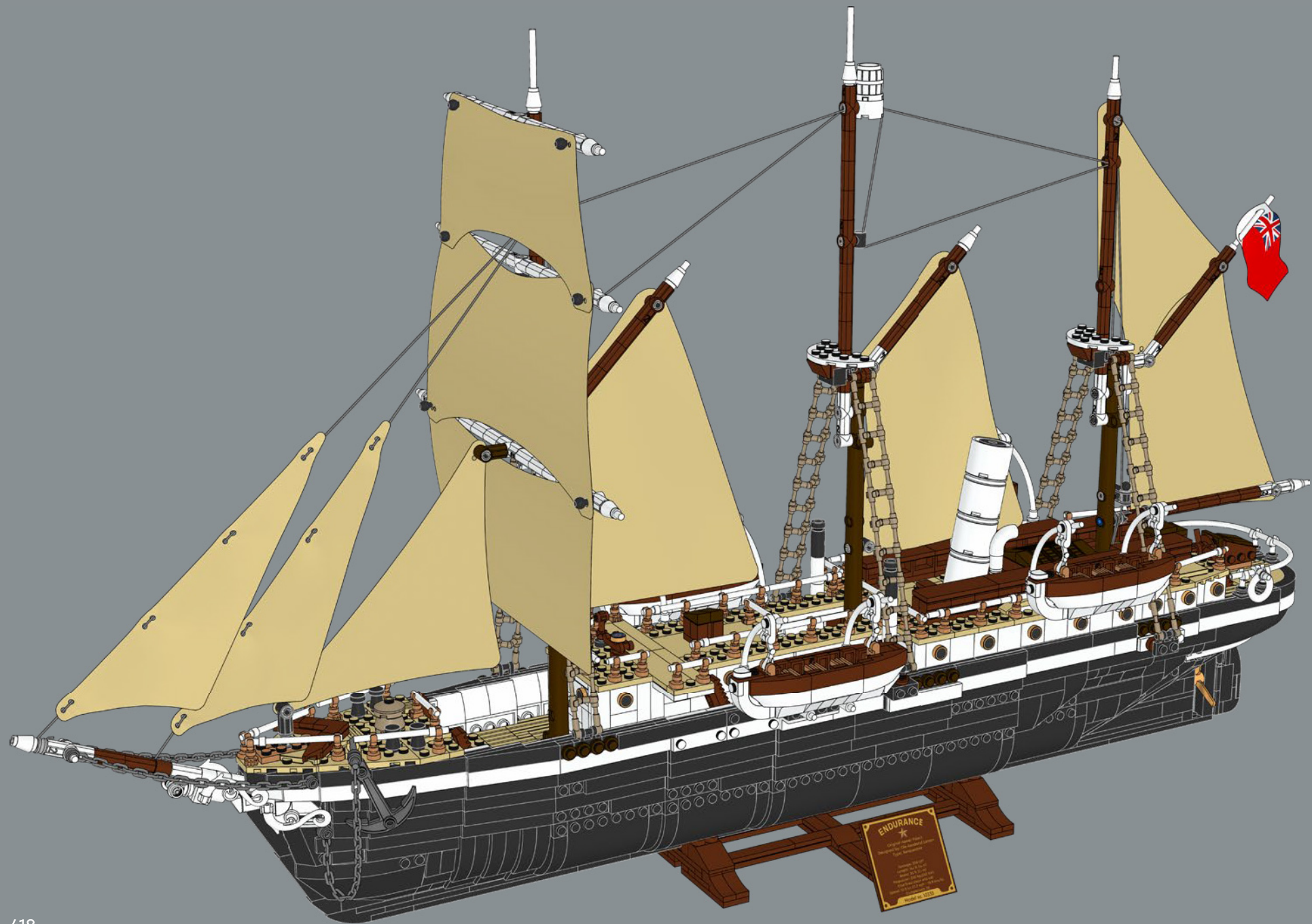

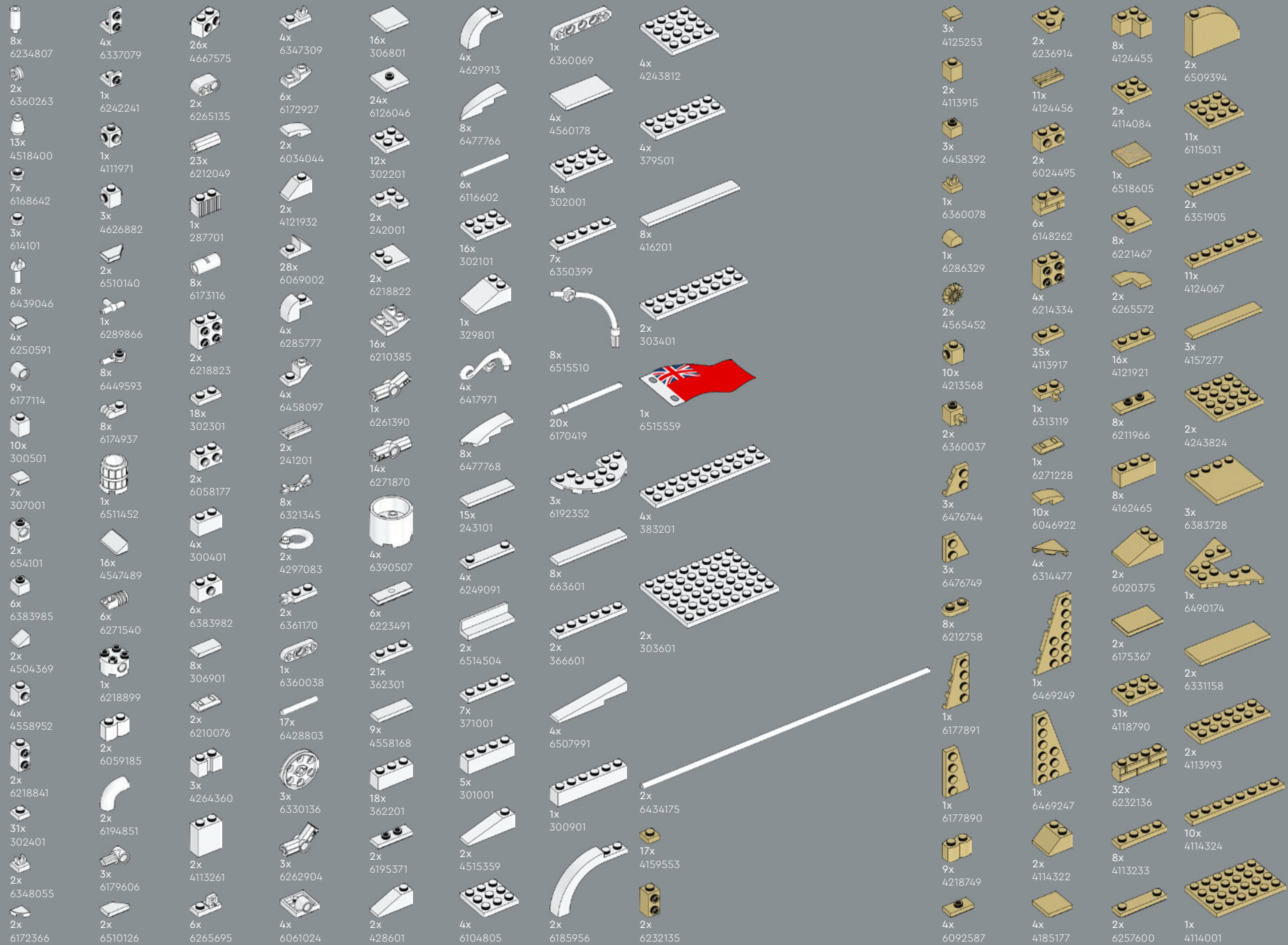

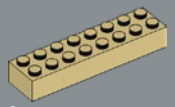

2x
6037398



3x
4143409

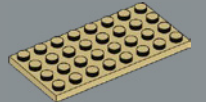

3x
4509897

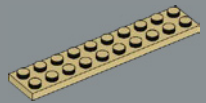

9x
4249019

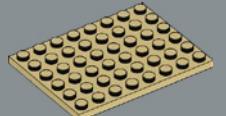

2x
6070501

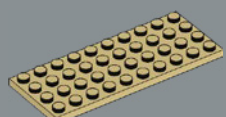

3x
6037834

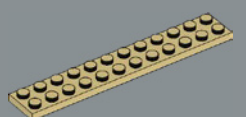

2x
6093864

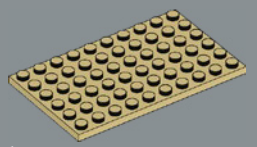

1x
4624185

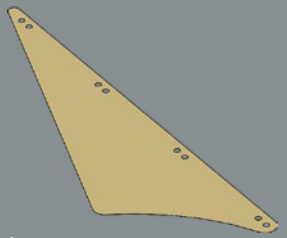

2x
6509959

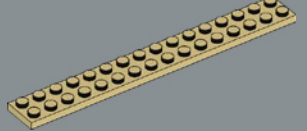

2x
6030980

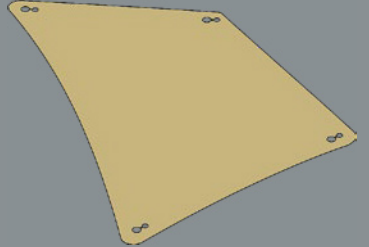

1x
6509952

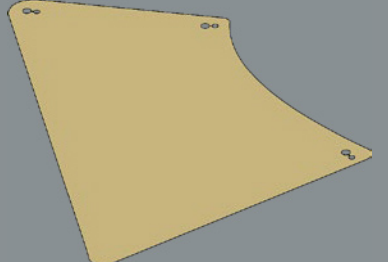

2x
6509954

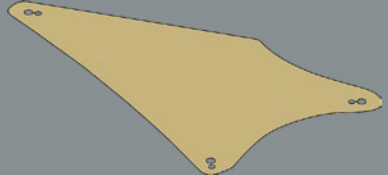

1x
6509953

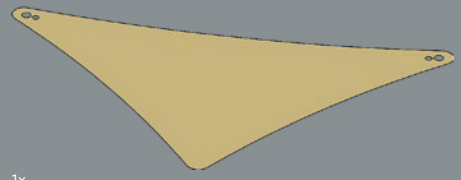

1x
6509958

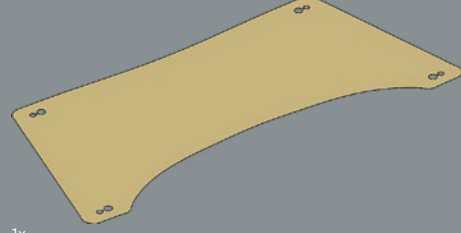

1x
6509955

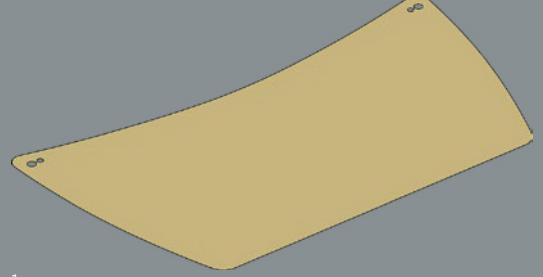

1x
6509957

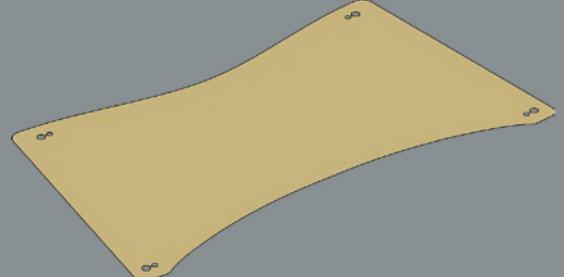

1x
6509956

- 2x 614121
- 1x 6271820
- 64x 4142865



1x
6129995



8x
300121



5x
4206482



4x
6271167



4x
6130007



1x
300124



4x
6186675



6x
6168646



4x
6284070



4x
4529236



1x
6332148



1x
6284699



8x
407026

4x
307026

22x
302426

2x
4504382

1x
654126

4



5x
6388352



2x
6335388



1x
4566308



6x
6234695



3x
4214559



2x
6509664



19x
6344752



1x
6141554



2x
6104209



1x
6265699



1x
6141556



2x
4180536



2x
4180508

6x
6513918

10x
4548180



2x
6051508



4x
6477759



9x
403226



18x
6279875



1x
4109810



1x
6271535



2x
6195325



1x
6143850



4x
6507846



6x
6282140



1x
4283260



28x
4253815



2x
6173119

7x
6047276

2x
6475339

18x
302326



2x
393726



1x
366526



8x
300426



9x
6092585



5x
306926



7x
6184784



6x
6069000



2x
4121966



4x
4140588



3x
4283047



3x
4283046



1x
6266224



1x
6396457

8x
242026



6x
303926



10x
302226



2x
6053077



2x
6390748



2x
4567436



3x
4124096



1x
6089119



1x
6276951



14x
362326



8x
428626



7x
362226



5x
4526931



1x
4251161

3x
6517676

2x
6390749





2x
4271874



1x
6511449



2x
6469351



3x
4211214



6x
6055145

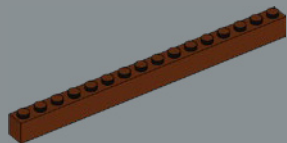

2x
6258989

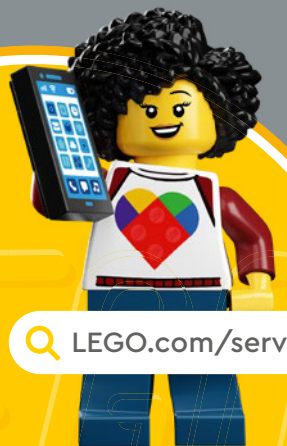

[LEGO.com/service](https://www.LEGO.com/service)

1x
6271165

2x
6275844

4x
6225242

6x
4211476

2x
4211389

1x
6329584

1x
6253856

2x
6248890

1x
6227897

1x
4211807

3x
4278273

3x
4211526

1x
6092956

1x
4512360

3x
6066097

4x
6123809

2x
6383177

6x
4211398

1x
4211470

1x
6004990

2x
6360043

10x
4211387

4x
4211397

9x
4211815

1x
4211536

4x
4211429

1x
6381253

6x
6093058

1x
4211773

8x
4211394

8x
4211425

8x
4251149

2x
6178172

2x
4211522

3

4x
4211090

6x
6231765

2x
6439040

4x
6395635

3x
6362259

7x
6344022

2x
6388133

1x
6225494

1x
4211042

1x
6115080

1x
6514456

2x
6230233

1x
4211066

3x
6092572

2x
6310596

6x
4210635

11

2x
6405646

6x
6015356

2x
4211133

3x
6365692

1x
4239891

1x
6378143

12x
4211043

4x
4211105

8x
4211001

1x
4211103

13x
6039176

2x
6431485

1x
4508553

11x
4211002

55

2x
4499858

1x
4211099

2x
4211114

3x
6258887

1x
6510133

32x
6511448

1x
6287847

2x
6186672

1x
6328909

1x
6034543

1x
6490722

32x
6315780

3x
6322813

1x
6332586

8

8x
6509391

8x
6509392

1x
4566688

2x
6058221

2x
6347604

1x
6515036

1x
6331950

3x
6258887

1x
6510133

32x
6511448

1x
6287847

2x
6186672

1x
6328909

1x
6034543

1x
6490722

32x
6315780

3x
6322813

1x
6332586

3x
6314190

3x
6457557

4x
6215606

2x
6474266

12x
6324205

2x
6360035

10x
4651231

2x
6192920

22x
6218360

2x
6431328

4x
6411587

2x
4656783

12x
6452541

8x
6167699

1x
6336665

1x
6452865

4x
6055309

1x
6257605

2x
6489195

31x
6343854

2x
6313600

4x
6208446

1x
6474270

1x
6474270

1x
6474270

1x
6492479

1x
6492479

1x
6492479

1x
6492479

1x
6492479

1x
6492479

1x
6492479



YOU COULD WIN



YOU COULD WIN

Your feedback will help shape the future development of this product series.

Visit:

DU KÖNNTEST GEWINNEN

Dein Feedback trägt zur Weiterentwicklung dieser Produktreihe bei.

Geh auf:

VOUS POURRIEZ GAGNER

Vos commentaires nous aideront à concevoir les futurs produits de cette gamme.

Visitez :

POTRESTI VINCERE TU

La tua opinione ci aiuterà a migliorare la creazione futura di questa linea di prodotti.

Visita:

PUEDES GANAR

Tu opinión contribuirá al futuro de esta serie de productos.

Visita:

轻松获奖

您的反馈将有助于我们在今后改进本产品系列。

请访问:

[LEGO.com/productfeedback](https://www.lego.com/productfeedback)

You also have the chance to win a LEGO® set.

Terms and conditions apply.*

Außerdem hast du die Chance, ein LEGO® Set zu gewinnen.

Es gelten die Teilnahmebedingungen.*

Vous pourriez également gagner un ensemble LEGO®.

Des conditions s'appliquent.*

Hai anche la possibilità di vincere un set LEGO®.

Termini e condizioni sono applicabili.*

También tienes la oportunidad de ganar un set LEGO®.

Aplican términos y condiciones.*

您还有机会赢取乐高®套装。

条款和条件适用。*

*[LEGO.com/productfeedback-terms](https://www.lego.com/productfeedback-terms)



LEGO and the LEGO logo are trademarks of the LEGO Group.
©2024 The LEGO Group.